

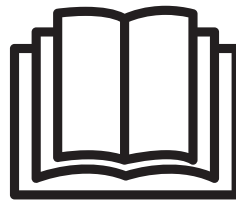

HAYWARD®

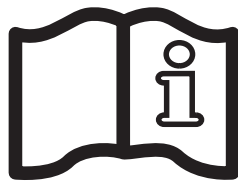
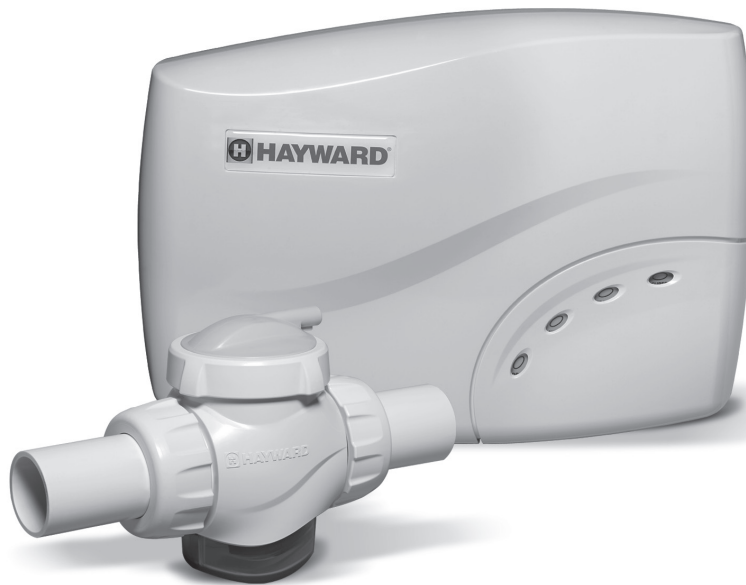

Salt & Swim™

USER'S GUIDE

SAVE THIS OWNER'S MANUAL



**WARNING: Electrical Hazard. Failure to follow instructions can result in serious injury or death.
FOR USE WITH SWIMMING POOLS**

⚠ WARNING – Disconnect this product from the main power supply completely before servicing the swimming pool equipment.

⚠ WARNING – All electrical connections must be done by a qualified electrician according to local electrical standard.

F	NF C 15-100	GB	BS7671:1992
D	DIN VDE 0100-702	EW	EVHS-HD 384-7-702
A	ÖVE 8001-4-702	H	MSZ 2364-702:1994 / MSZ 10-533 1/1990
E	UNE 20460-7-702 1993, REBT ITC-BT-31 2002	M	MSA HD 384-7-702.S2
IRL	Normas de cableado + IS HD 384-7-702	PL	PN-IEC 60364-7-702:1999
I	CEI 64-8/7	CZ	CSN 33 2000 7-702
LUX	384-7.702 S2	SK	STN 33 2000-7-702
NL	NEN 1010-7-702	SLO	SIST HD 384-7-702.S2
P	RSIUEE	TR	TS IEC 60364-7-702

⚠ WARNING – Be certain the product is only plugged into a protected 230 V_~ outlet that is protected from short-circuits. The product is to be supplied by an isolating transformer or supplied through a residual current device (RCD) having a rated residual operating current not exceeding 30 mA.

⚠ WARNING – Children should be supervised to ensure that they do not play with the appliance. Keep fingers and foreign objects away from openings and moving parts.

⚠ WARNING – Make sure that the power supply voltage required by the product corresponds to that of the distribution network and that the power supply cables matches the power and current of the product.

⚠ WARNING – Do not bury cord. Locate cord to minimize abuse from lawn mowers, hedge trimmers, and other equipment.

⚠ WARNING – To reduce the risk of electric shock, do not use extension cord to connect unit to electric supply; provide a properly located outlet.

⚠ WARNING – Read and follow all instructions in this owner’s manual and on the equipment. Failure to follow instructions can cause serious injury or death.

This document should be given to the owner of the swimming pool and must be kept by the owner in a safe place.

⚠ WARNING – This appliance is not intended for use by persons (including children) with reduced physical, sensory or mental capabilities, or lack of experience and knowledge, unless they have been given supervision or instruction concerning use of the appliance by a person responsible for their safety.

⚠ WARNING – Use Only Genuine Hayward Replacement Parts.

⚠ WARNING – If the supply cord is damaged it must be replaced by the manufacturer, service agent, or similarly qualified persons in order to avoid a hazard.

⚠ WARNING – Do not operate the product if the power cord is damaged. This can cause an electric shock. A damaged power cord must be replaced by a service agent or a similarly qualified person immediately in order to avoid a hazard.

USE ONLY GENUINE REPLACEMENT PARTS

REGISTRATION

Thank you for choosing Hayward. This manual contains important information regarding the operation and maintenance of your product. Please retain it for reference.

TO REGISTER YOUR PRODUCT IN OUR DATABASE, GO TO:
www.hayward.fr/en/services/register-your-product

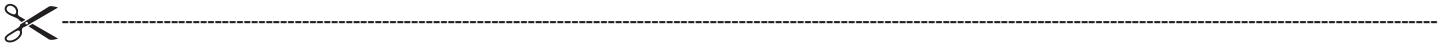

For Your Records

Record the following information for your convenience:

- 1) Purchase Date _____
- 2) Complete Name _____
- 3) Address _____
- 4) Zip code _____
- 5) Email Address _____
- 6) Part number _____ Serial number _____
- 7) Pool Dealer _____
- 8) Address _____
- 9) Zip code _____ Country _____

Note

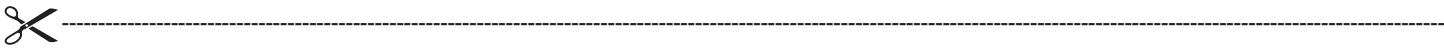

USE ONLY GENUINE REPLACEMENT PARTS

GENERAL

The Salt & Swim is an automatic chlorine generation system for pool sanitation. The operation requires a low concentration of salt (sodium chloride) in the pool water. The Salt & Swim automatically sanitizes your pool by converting the salt into free chlorine which kills bacteria and algae in the water. Chlorine will revert back to sodium chloride after killing bacteria. These reactions will continuously recycle virtually eliminating the need to add sanitizing chemicals to your pool.

The Salt & Swim can handle the purification needs of most residential swimming pools.

The Salt & Swim is offered in two models: 22 g/h (Pool < 110 m³) et 15 g/h (Pool < 75 m³).

Note that the actual amount of chlorination required to properly sanitize a pool varies due to bather load, rainfall, temperature, and the pool's cleanliness.

NOTE: Before installing this product as part of a saline water purification system in a pool or spa using natural stone for coping or for immediately adjacent patios/decking, a qualified stone installation specialist should be consulted regarding the appropriate type, installation, sealant (if any) and maintenance of stone used around a saline pool with electronic chlorine generator in your particular location and circumstances.

NOTE: The use of dry acid (sodium bisulfate) to adjust pool pH is discouraged especially in arid regions where pool water is subject to excessive evaporation and is not commonly diluted with fresh water. Dry acid can cause a buildup of by-products that can damage your chlorinator Cell.

INSTALLATION

Remove power to the pool filter pump before starting this installation. Installation must be performed in accordance with Local and NEC codes. The Control Box must be mounted a minimum of 3.5 meters horizontal distance (or more, if local codes require) from the pool, within 2 meters from a protected outlet, and within 4.5 meters from where the Cell will be installed. Take care to protect the Cell cap connector pins while handling the Salt & Swim unit during installation.

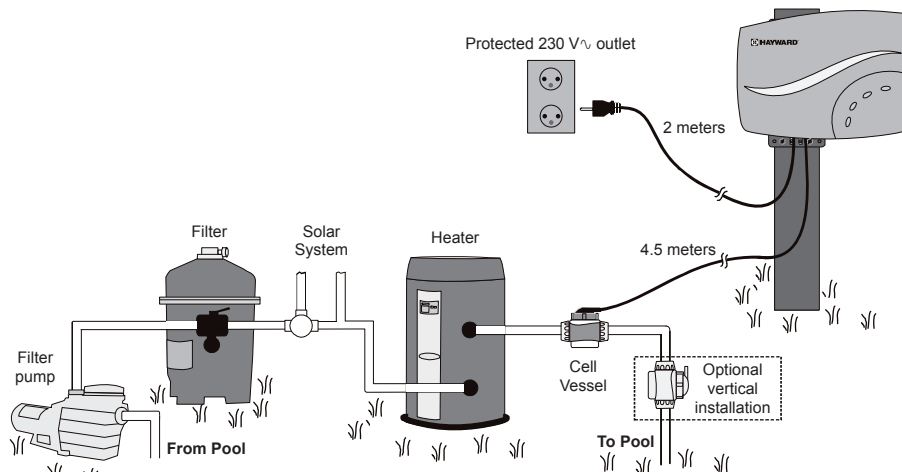

Preparing Pool Water

To prepare the pool water for Salt & Swim operation, the pool's chemistry must be balanced and salt must be added. This must be done **BEFORE** activating the Salt & Swim. Some adjustments to your pool chemistry may take several hours, so start the procedure well before you intend to operate the Salt and Swim.

Adding Salt: Add salt several hours or, if possible, 1 day prior to operating the Salt & Swim. Take care not to exceed the recommended salt level. Measure salt 6-8 hours after adding to the pool.

USE ONLY GENUINE REPLACEMENT PARTS

NOTE: If the pool does not have new water, add 1 liter of metal remover and 1 liter of non-copper based algaecide to the pool, per manufacturer's instructions. This ensures a quick, trouble free transfer to the Salt & Swim system.

Salt & Swim Installation

Follow the step by step instructions located on the Installation Quick Start Guide. Refer to the following sections for more detailed information.

Mounting the Salt & Swim Control Box

The Salt & Swim is contained in a raintight enclosure that is suitable for outdoor mounting. The Control Box must be mounted a minimum of 3.5 meters horizontal distance (or more, if local codes require) from the pool, within 2 meters from a protected outlet, and within 4.5 meters from where the Cell is installed.

The Control Box is designed to mount vertically on a flat surface with the cables facing downward. Because the enclosure also acts as a heat sink (disperses heat from inside the box), it is important not to block the four sides of the Control Box. Do not mount Salt & Swim inside a panel or tightly enclosed area.

Before securing the Control Box to the intended location, make sure that the power cord will reach the protected outlet and that the Cell cable will reach the location where the Cell Vessel will be installed. Use the included Mounting Template to position the fasteners to the mounting surface. Refer to the diagram below.

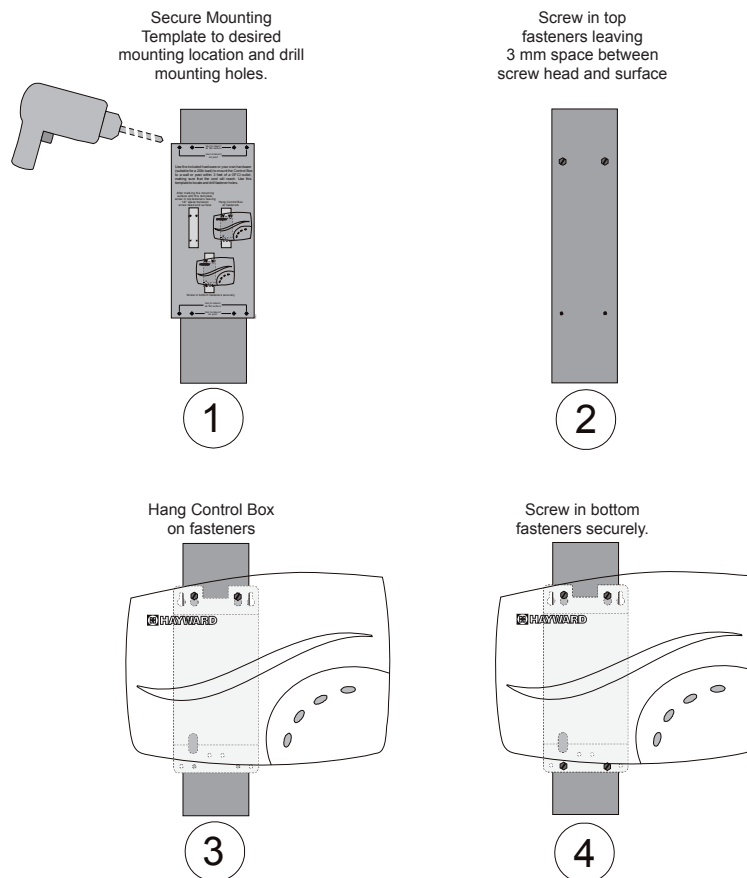

Plumbing

The Cell Vessel is designed to install in 50 mm PVC pool plumbing. The Cell Vessel must be installed on a 25 cm run of straight pipe at the end of the return piping just before the water returns to the pool. All pool equipment should be upstream from the Cell Vessel. It must be located within 4.5 meters of where the Control Box is mounted. Also, there must be enough clearance to insert and remove the Cell from the Vessel after the Vessel is installed.

USE ONLY GENUINE REPLACEMENT PARTS

With power removed to the pump and water drained from the pool plumbing, secure the Cutting Template to the location where the Cell Vessel will be installed. Note that the Cutting Template is the same width as the Cell Vessel. The entire Cutting Template must fit on the pipe otherwise the Cell Vessel will not fit. With the Cutting Template secure on the pipe, mark all 10 cutouts on to the pipe using a waterproof permanent marker.

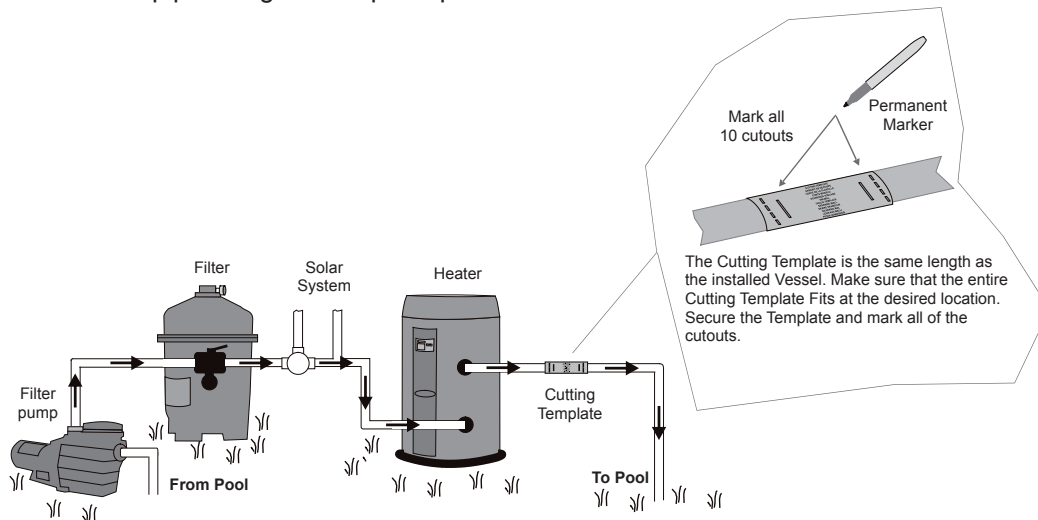

Remove the Template, cut the pipe and install the Nut Assemblies as shown below. Use the included 50 mm Nut Assembly for 50 mm pipe. Place Nut Assembly on each side of the cut pipe (threads face in). Be sure to place the Nut, Compression Ring and Collar on the pipe as shown in the diagram (n°1).

Or use the included 50 mm union (N°2).

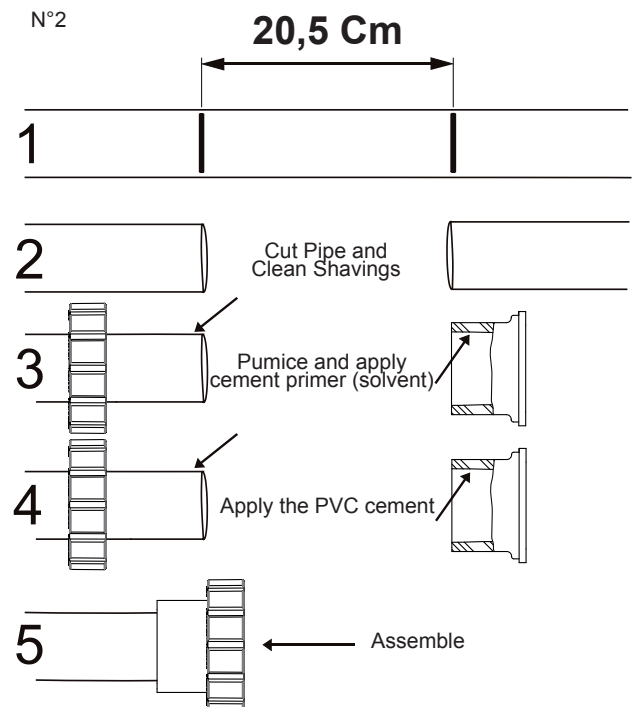
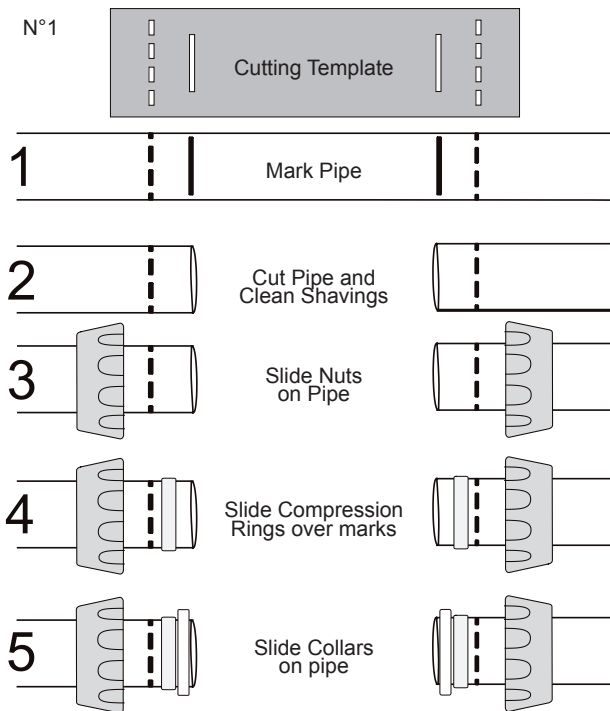

USE ONLY GENUINE REPLACEMENT PARTS

Position the Vessel in a manner where the Cell can be easily inserted and removed. Secure the Vessel to the cut pipe by tightening the Nuts as shown below. Hand tighten the Nuts to stop, then continue 1/4 turn more using the included strap wrench. If the Inspection marks can be seen, the pipe has not been inserted far enough into the Cell Vessel.

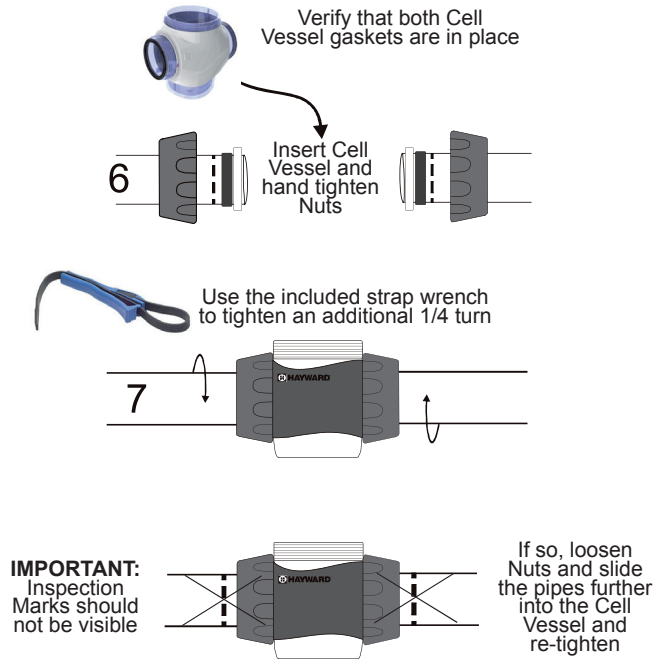

Remove the foam protector from the Cell. Verify that the O-Ring is attached before inserting the Cell into the Cell Vessel. Put a little grease on the connectors.

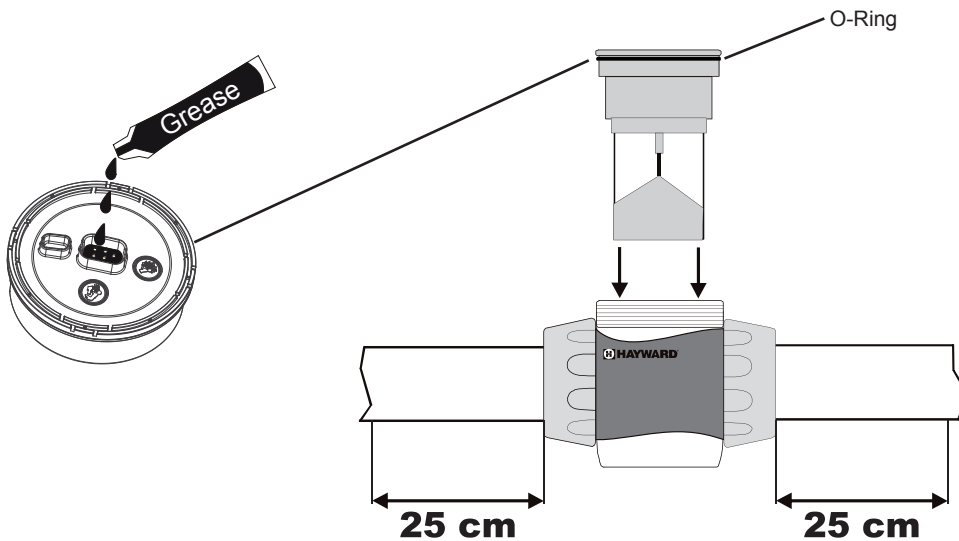

USE ONLY GENUINE REPLACEMENT PARTS

Connect and Fasten Cell Cap

Slip the Cell Cap through the Retaining Nut as shown below. Plug the Cell Cap into the Cell and secure with the Retaining Nut. Run pump for 5 minutes and check for leaks.

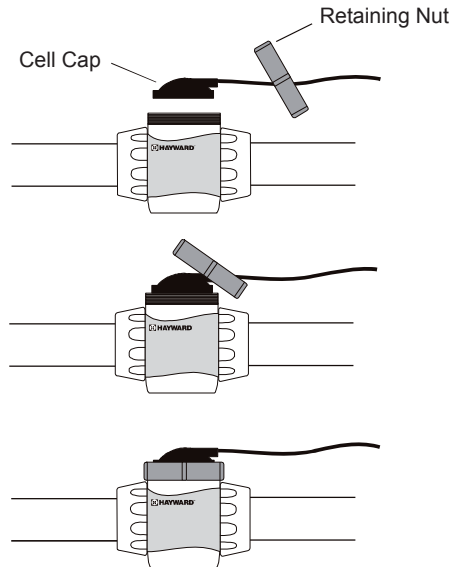



Flow Switch Calibration Procedure

IMPORTANT: Before going any further, the pool water must be balanced and salt must be added to your pool. If this has not already been done, refer to the “Water Chemistry” section of this manual for information on how to prepare your pool water for Salt & Swim operation.

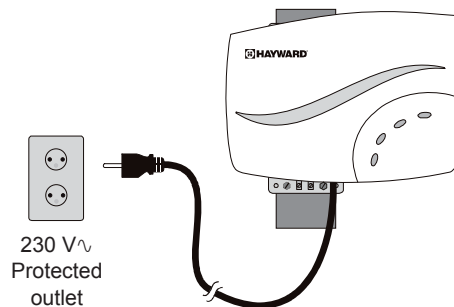

At start-up, or when a new Cell is installed, the Salt & Swim will run a Flow Switch Calibration procedure to ensure that the Cell’s flow switch is properly initialized. This will occur just once when a new Cell is installed. After the flow switch is initialized, the Salt & Swim will not perform this procedure again until the Cell is replaced. The Flow Switch Calibration procedure will require the user to cycle the pump on and off. Follow the instructions below:

1. Turn the filter pump OFF.
2. Plug the Salt & Swim’s linecord into a protected outlet. Follow Local and National codes.



After being powered on for the first time, the Salt & Swim will run a diagnostic routine which can take up to 30 seconds. During this time, various LEDs will turn on and off. When finished, the Salt & Swim will display a blinking  LED and a solid  LED. Keep the Salt & Swim powered for the remainder of this procedure and go to Step 3.

USE ONLY GENUINE REPLACEMENT PARTS

3. Turn the filter pump ON. Make sure that full flow is achieved (no air in the system) and run the pump for at least 15 seconds.
4. Turn the filter pump OFF.
5. The Salt & Swim should now display a solid  LED and a solid  LED. The Flow Switch Calibration procedure is complete. You can now turn on your filter pump and begin normal operation.

If the  LED is still blinking after performing this procedure, refer to the Troubleshooting section of this manual.

Water Chemistry

The table below summarizes the levels that are recommended by Hayward. The only special requirements for the Salt & Swim are the salt level and stabilizer. It is important to maintain these levels in order to prevent corrosion or scaling and to ensure maximum enjoyment of the pool. Test your water periodically. Your authorized Salt & Swim dealer or most pool stores can provide you with the chemicals and procedures to adjust the water chemistry. Be sure to tell the pool store that you are using a Salt & Swim chlorine generator.

CHEMICAL	IDEAL LEVELS
Salt	2.7 to 3.4 g/l
Free Chlorine	1.0 to 3.0 ppm
pH	7.2 to 7.6
Cyanuric Acid (Stabilizer)	20 to 30 ppm (25 ppm best) Add stabilizer only if necessary
Total Alkalinity	80 to 120 ppm
Calcium Hardness	200 to 300 ppm
Metals	0 ppm
Saturation Index	-.2 to .2 (0 best)

Saturation index

The saturation index (Si) relates to the calcium and alkalinity in the water and is an indicator of the pool water “balance”. Your water is properly balanced if the Si is 0 ± 0.2 . If the Si is below -0.2 , the water is corrosive and plaster pool walls will be dissolved into the water. If the Si is above $+0.2$, scaling and staining will occur. Use the chart below to determine the saturation index.

$$Si = pH + Ti + Ci + Ai - 12.1$$

°C	°F	Ti	Calcium Hardness	Ci	Total Alkalinity	Ai
12	53	0.3	75	1.5	75	1.9
16	60	0.4	100	1.6	100	2.0
19	66	0.5	125	1.7	125	2.1
24	76	0.6	200	1.9	200	2.3
29	84	0.7	250	2.0	250	2.4
34	94	0.8	300	2.1	300	2.5
39	100	0.9	400	2.2	400	2.6
			600	2.4	600	2.8
			800	2.5	800	2.9

How to use: Measure pool pH, temperature, calcium hardness, and total alkalinity. Use the chart above to determine Ti, Ci and Ai into the above equation. If Si equals 0.2 or more, scaling and staining may occur. If Si equals -0.2 or less corrosion or irritation may occur.



USE ONLY GENUINE REPLACEMENT PARTS

Salt Level

Use the chart on page 11 to determine how much salt in Kgs need to be added to reach the recommended levels. Use the equations below if pool size is unknown.

	M³ (pool size in meters)
Rectangular	Length x Width x Average Depth
Round	Diameter x Diameter x Average Depth x 0.785
Oval	Length x Width x Average Depth x 0.893

The ideal salt level is between 2.7 - 3.4 g/L with 3.2 g/L being ideal. If the level is low, determine the number of M³ in the pool and add salt according to the chart on page 11. A low salt level will reduce the efficiency of the Salt & Swim and result in low chlorine production. A high salt level can cause the Salt & Swim to shutdown and may begin to give a salty taste to your pool (generally, the salt will begin to be tasted at a level of about 3.5 - 4.0 g/L). The salt in your pool is constantly recycled and the loss of salt throughout the swimming season should be small. This loss is due primarily to the addition of water because of splashing, backwashing, or draining (because of rain). Salt is not lost due to evaporation.

Type of Salt to Use

It is important to use only sodium chloride (NaCl) salt that is greater than 99% pure. This is common food quality or water softener salt and is usually available in 25 kg bags. It is also acceptable to use water conditioning salt pellets, however, it will take longer for them to dissolve. Do not use rock salt, salt with yellow prussiate of soda, salt with anti-caking additives, or iodized salt.

How to Add or Remove Salt

For new plaster pools, wait 10-30 days (check with you local pool professional) before adding salt to allow the plaster to cure. Turn the circulating pump on and add salt directly into the pool. Brush the salt around to speed up the dissolving process--do not allow salt to pile up on the bottom of the pool. Run the filter pump for 24 hours with the suction coming from the main drain (use pool vac if there is no main drain) to allow the salt to evenly disperse throughout the pool.

The only way to lower the salt concentration is to partially drain the pool and refill with fresh water.

Always check stabilizer (cyanuric acid), when checking salt. These levels will most likely decline together. Use the chart on page 11 to determine how much stabilizer must be added to raise the level to 25 ppm maximum (Use stabilizer only if necessary).

WEIGHT OF SALT (Kg) NEEDED FOR 3.2 g/l

Current salt level g/l	M ³ of Pool water																
	30	37.5	45	52.5	60	67.5	75	82.5	90	97.5	105	112.5	120	127.5	135	142.5	150
0	97	121	145	170	194	218	242	267	291	315	339	364	388	412	436	460	484
0.2	91	114	136	159	182	205	227	250	273	295	318	341	363	385	408	430	453
0.4	85	106	127	148	170	191	212	233	255	276	297	318	339	360	382	403	424
0.6	79	98	118	138	158	177	197	217	236	256	276	297	317	337	358	378	398
0.8	73	91	109	127	145	164	182	200	218	236	255	273	291	310	328	346	364
1	67	83	100	117	133	150	167	183	200	217	233	250	267	283	300	317	333
1.2	61	76	91	106	121	136	152	167	182	197	212	227	243	258	274	289	304
1.4	55	68	82	95	109	123	136	150	164	177	191	205	218	232	246	259	263
1.6	48	61	73	85	97	109	121	133	145	158	170	182	195	207	219	231	243
1.8	42	53	64	74	85	95	106	117	127	138	148	159	169	180	190	201	211
2	36	45	55	64	73	82	91	100	109	118	127	136	145	154	163	172	181
2.2	30	38	45	53	61	68	76	83	91	98	106	114	121	129	137	144	152
2.4	24	30	36	42	48	55	61	67	73	79	85	91	98	104	110	117	123
2.6	18	23	27	32	36	41	45	50	55	59	64	68	73	77	81	86	90
2.8	12	15	18	21	24	27	30	33	36	39	42	45	48	51	54	57	60
3	6	8	9	11	12	14	15	17	18	20	21	23	24	26	27	29	30
3.2	Ideal	Ideal	Ideal	Ideal	Ideal	Ideal	Ideal	Ideal	Ideal	Ideal	Ideal	Ideal	Ideal	Ideal	Ideal	Ideal	Ideal
3.4	OK	OK	OK	OK	OK	OK	OK	OK	OK	OK	OK	OK	OK	OK	OK	OK	OK
3.6 & +	Dilute	Dilute	Dilute	Dilute	Dilute	Dilute	Dilute	Dilute	Dilute	Dilute	Dilute	Dilute	Dilute	Dilute	Dilute	Dilute	Dilute

WEIGHT OF STABILIZER (CYANURIC ACID in Kg) NEEDED FOR 25 PPM

Current Stabilizer level in ppm	M ³ of Pool water																
	30	37.5	45	52.5	60	67.5	75	82.5	90	97.5	105	112.5	120	127.5	135	142.5	150
0 ppm	0.75	0.94	1.13	1.34	1.53	1.69	1.91	2.09	2.28	2.47	2.66	2.84	3.03	3.22	3.41	3.59	3.75
10 ppm	0.45	0.56	0.68	0.81	0.92	1.01	1.14	1.26	1.37	1.48	1.59	1.71	1.82	1.93	2.04	2.16	2.25
20 ppm	0.15	0.19	0.23	0.27	0.31	0.34	0.38	0.42	0.46	0.49	0.53	0.57	0.61	0.64	0.68	0.72	0.75
25 ppm	0	0	0	0	0	0	0	0	0	0	0	0	0	0	0	0	0

USE ONLY GENUINE REPLACEMENT PARTS

Controls

The main controls and indicators are shown below.

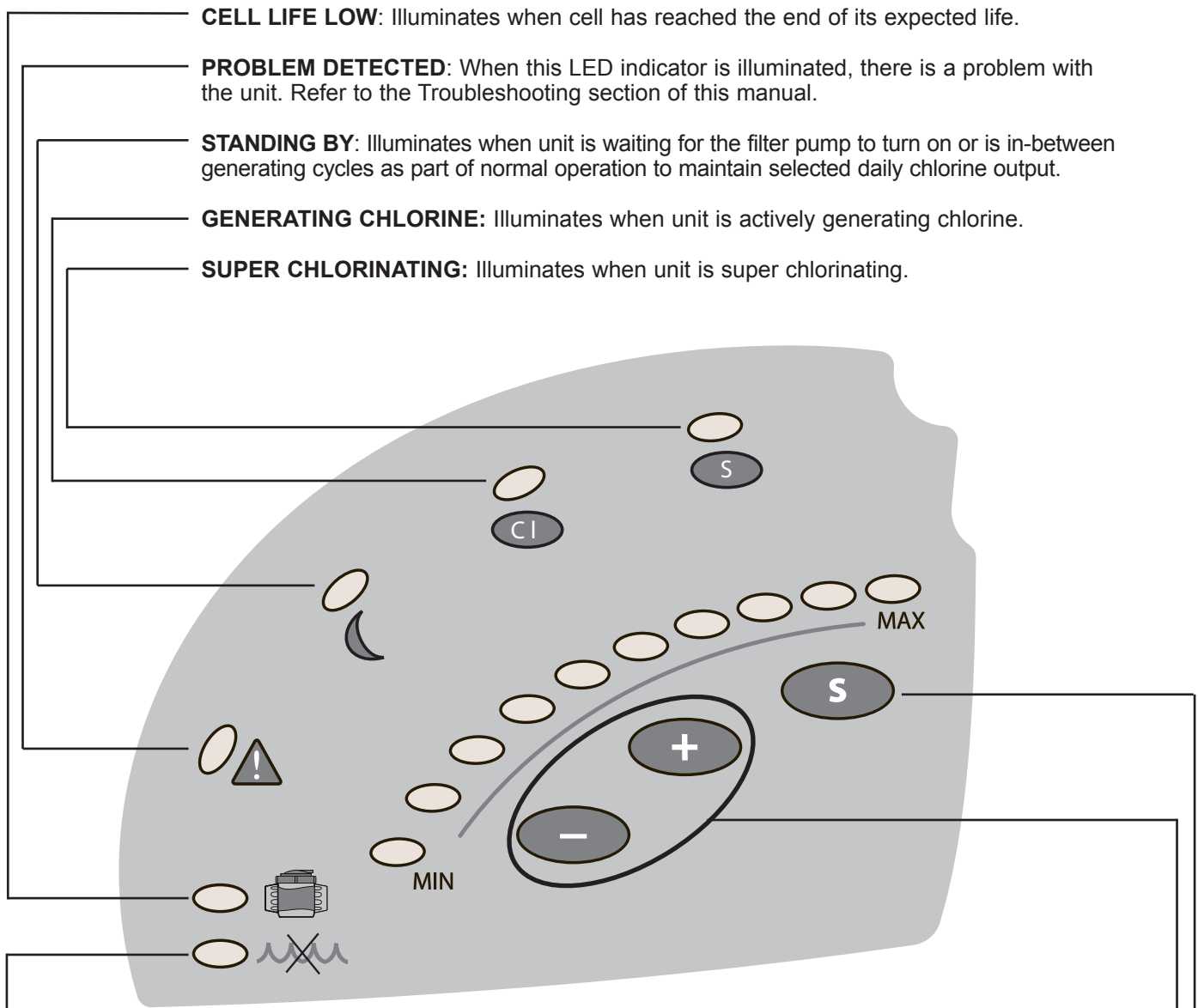

- CELL LIFE LOW:** Illuminates when cell has reached the end of its expected life.
- PROBLEM DETECTED:** When this LED indicator is illuminated, there is a problem with the unit. Refer to the Troubleshooting section of this manual.
- STANDING BY:** Illuminates when unit is waiting for the filter pump to turn on or is in-between generating cycles as part of normal operation to maintain selected daily chlorine output.
- GENERATING CHLORINE:** Illuminates when unit is actively generating chlorine.
- SUPER CHLORINATING:** Illuminates when unit is super chlorinating.

INADEQUATE WATER FLOW: Illuminates when there is no flow or low flow through the cell. The pool filter pump could be in its "off" cycle. If this is not the case, refer to the Troubleshooting section in this manual. Blinks when performing the Flow Switch Calibration procedure.

DAILY CHLORINE OUTPUT: Press (+) and (-) to increase or decrease the chlorine generation. The **DAILY CHLORINE OUTPUT** LEDs above these buttons will indicate the relative amount of chlorine being generated.

SUPER CHLORINATE: When you have an abnormally high bather load, a large amount of rain, a cloudy water condition, or any other condition which requires a large amount of purification to be introduced, press the **S** button. This electronically "super chlorinates" (boosts chlorine generation output) the water for 24 hours (filter pump must be on during this time). To cancel super chlorinating, press the **S** button again.

USE ONLY GENUINE REPLACEMENT PARTS

OPERATION

The Salt & Swim does not have an ON/OFF switch. The unit is designed to be plugged into a protected outlet at all times. There should be no need to remove power from the Salt & Swim unless pool components are being serviced or the pool will be closed.







When power is first applied to the Salt & Swim, an initialization routine will run for approximately 30 seconds. During this time, various LEDs will illuminate. This is perfectly normal and does not require any input from the user. When the routine is finished, the Salt and & Swim will begin normal operation.

If the water chemical levels are in the recommended range, there are three factors that you can control which directly contribute to the amount of chlorine the Salt & Swim will generate:

1. filter time each day (hours)
2. the DAILY CHLORINE OUTPUT setting
3. the amount of salt in the pool

The filter pump timer should be set so that all of the water in the pool passes through the filter at least once each day. For pools with high chlorine demand, the timer may have to be set longer to generate enough chlorine.

Daily Chlorine Output Setting

You can adjust the amount of chlorine that is generated using the  and  button on the Salt & Swim unit. The DAILY CHLORINE OUTPUT LEDs will display the current setting. Push  to increase and  to decrease the current setting. Each DAILY CHLORINE OUTPUT LED represents 6 minutes of chlorine generation out of 1 hour. For example, if 5 LEDs are illuminated, the Salt & Swim unit will generate chlorine for 5 x 6 = 30 minutes out of every hour of operation. During this time, the  LED will be lit. The unit will be idle for the remaining 30 minutes at which time the  LED will turn off and the  LED will illuminate.

To find the optimum setting, start the operation with 5 DAILY CHLORINE OUTPUT LEDs illuminated. Test the chlorine level every few days and adjust up or down accordingly. It usually takes 2-3 adjustments to find the ideal setting for your pool and after that, it should only take minor, infrequent adjustments. Because the chlorine demand of the pool increases with temperature, most people find they have to adjust up at the peak of the summer and down during colder periods. The Salt & Swim automatically scales back to 12 minutes of output per hour (if set higher than 12 minutes) when the pool water is 10°C - 15°C. This protects the unit as well as prevents possible over-chlorination. The Salt & Swim stops generating when the pool water temperature drops below 10°C. This is usually not a problem because bacteria and algae stop growing at this temperature. You can override these automatic low temperature operations by switching to SUPER CHLORINATE for a day.

NOTE: After the ideal DAILY CHLORINE OUTPUT setting has been found, you may need to raise the setting when the pool water temperature increases significantly, when there is higher than normal bather load or when the Salt & Swim Cell ages. You may need to lower the setting when the pool water temperature decreases significantly or there are long periods of inactivity.

Prevent over-chlorination during cold weather: Check chlorine levels periodically. Most pools require less chlorine during cold weather and the DAILY CHLORINE OUTPUT should be lowered accordingly.

Maintaining the Salt & Swim System

The replaceable Cell uses the same electronic self cleaning technology as the popular Hayward Turbo Cell. In most cases this self cleaning action will keep the Cell working at optimum efficiency. In areas where water is hard (high mineral content) and in pools where the water chemistry has been allowed to get "out of balance," the Cell may require periodic cleaning.

Servicing and Cleaning the Salt & Swim Cell

Unplug the Salt & Swim from the protected outlet before attempting to remove the electrolytic Cell. Once removed, look inside the Cell and inspect for scale formation (light colored crusty or flaky deposits) on the plates and for any debris which has passed through the filter and caught on the plates. If no deposits are visible, reinstall. If deposits are seen, use a high pressure garden hose and try to flush the scale off. If this is not successful, use a plastic or wood tool (do not use metal as this will scratch the coating off the plates) and scrape deposits off of plates. Note that a buildup on the

USE ONLY GENUINE REPLACEMENT PARTS

Cell indicates that there is an unusually high calcium level in the pool (old pool water is usually the cause). If this is not corrected, you may have to periodically clean the Cell. The simplest way to avoid this is to bring the pool chemistry to the recommended levels as specified.

Mild Acid Washing: Use only in severe cases where flushing and scraping will not remove the majority of deposits. To acid wash, unplug the Salt & Swim unit from the protected outlet and unplug the Cell cord from the replaceable Cell. Remove the Cell from the Vessel by unscrewing the Retaining Nut and gently pulling the Cell from the Vessel. In a clean plastic container, mix a solution of water to phosphoric or citric acid. **ALWAYS ADD ACID TO WATER - NEVER ADD WATER TO ACID.** Be sure to wear rubber gloves and appropriate eye protection. The level of the solution in the container should just reach the top of the Cell so that the cylindrical electronics compartment is not submerged. The Cell should soak for a few minutes and then rinse with a high pressure garden hose. If any deposits are still visible, repeat soaking and rinsing. Replace Cell and inspect again periodically.

Winterizing

The Salt & Swim replaceable Cell will be damaged by freezing water just as your pool plumbing would. In areas of the country which experience severe or extended periods of freezing temperatures, be sure to drain all water from the pump, filter, and supply and return lines before any freezing conditions occur. The Control Box and plumbed in Cell Vessel are capable of withstanding any winter weather and should not be removed.

Spring Start-up

DO NOT turn the Salt & Swim on until the pool water chemistry has been brought to the proper levels. Refer to the “Water Chemistry” section of this manual for information on how to prepare your pool water for Salt & Swim operation.

TROUBLESHOOTING

Common Problems and Solutions

The Salt & Swim's various LEDs show the operation status as well as alert the user to any problems that may have occurred. Some indications may require a combination of LEDs to illuminate. To aid in interpreting these indications, Hayward has created an interactive tool located at Services on our web site www.hayward.fr. Use this tool and the information below to identify and correct problems that may arise.

1. Possible causes of little or no free chlorine residual

- DAILY CHLORINE OUTPUT adjustment setting is too low
- Low stabilizer (Cyanuric Acid)
- Filter pump time too short (8 hours for average size pools, more for large pools)
- Salt level too low (below 2.4 g/l)
- Salt level too high
- Very warm pools increase chlorine demand--increase Output %, or filter run time
- Cold water below 10°C causes Salt & Swim to stop generating
- Cold water between 10°C - 15°C causes Salt & Swim to reduce output regardless of DAILY CHLORINE OUTPUT setting
- Excessive scaling on Cell.
- High level of Nitrogen in pool water.
- “Yellow Out” or similar treatment recently used. Some yellow algae treatments will use chlorine at a very high rate and deplete the residual free chlorine. Manually shock the pool if indicated in the directions on the algae treatment. It still may be a matter of days before the pool returns to “normal” and chlorine tests will show the desired 1 - 3ppm free chlorine reading.

2. LEDs not on

Depending on current conditions, there should always be at least one LED illuminated when the Salt & Swim is powered. If no LEDs are on, check to make sure that the linecord is plugged in and that the protected outlet is powered. If no power is detected, the protection may have to be reset.

3. LED blinking

The Salt & Swim has shut down because the temperature of the pool water is too high (49°C) or too low (10°C). The system will not resume operation until the water temperature returns to normal. Note: This condition can sometimes happen if the pool temperature is already high and the heater is running. The temperature coming out of the heater and into the Cell could possibly be high enough to shut down the Salt & Swim.

USE ONLY GENUINE REPLACEMENT PARTS

4. LED illuminated

The Salt & Swim has sensed a low flow or no flow condition and has stopped generating chlorine.

- Verify that the filter pump is running and there are no obstructions or restrictions in the pool plumbing.
- Backwash the pool filter.
- Increase the speed of your variable speed pump

If the condition persists, remove the Cell from the Vessel and check that the flow switch is free to move in both directions. Refer to the diagram below.

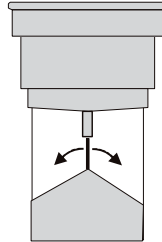

5. LED illuminated

The Cell has reached the end of its life. Replace as soon as possible

6. LED illuminated AND a DAILY CHLORINE OUTPUT LED is blinking

The Salt & Swim may display an error by illuminating the  LED and blinking one of the DAILY CHLORINE OUTPUT LEDs. There are ten DAILY CHLORINE OUTPUT LEDs that each indicate a different error.

These LEDs are labeled with a number on the diagram below. Refer to our website for their corresponding errors : <http://www.hayward-pool.co.uk/en/services/salt-a-swim-troubleshooting-assistant>

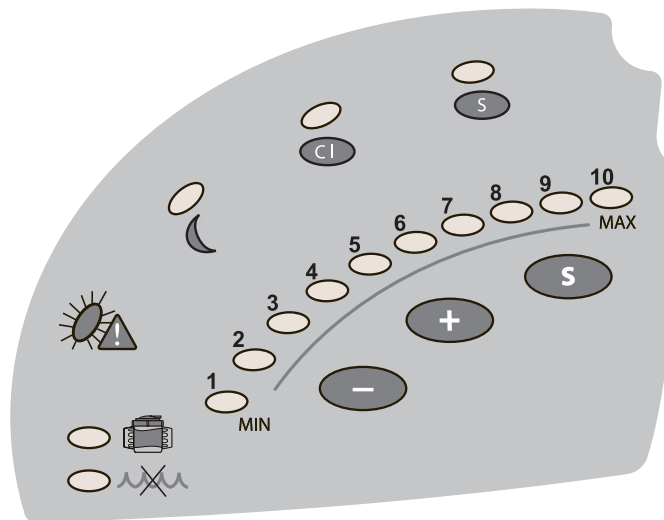

7. LED illuminated AND MAX LED blinking

There is a communication error with the Cell. Check that the Cell cap is properly plugged in and that the wire to the Control Box is not cut or damaged.

8. LED illuminated AND MIN LED blinking

- The salt level may be too low. Adjust salt to recommended levels.
- Remove and inspect the Cell for scale. If the Cell is scaled, follow the directions on “**Servicing and Cleaning the Salt & Swim Cell**” chapter.

9. LED illuminated AND 20% LED blinking

Salt level is too high. Test the salt level and adjust to the recommended levels.

USE ONLY GENUINE REPLACEMENT PARTS

GARANTIE LIMITÉE

Les produits HAYWARD sont garantis contre tous défauts de fabrication ou de matières pendant **2 ans**, à compter de la date d'achat. Toute demande d'application de la garantie devra s'accompagner de la preuve d'achat, portant mention de la date. Nous vous conseillons donc de conserver votre facture.

Dans le cadre de sa garantie, HAYWARD choisira de réparer ou de remplacer les produits défectueux, sous condition d'avoir été utilisés selon les instructions du guide correspondant, de n'avoir subi aucune modification, et de ne comporter que des pièces et composants d'origine. La garantie ne couvre pas les dommages dus au gel et aux produits chimiques. Tous les autres coûts (transport, main-d'œuvre, etc.) sont exclus de la garantie.

HAYWARD ne pourra être tenue pour responsable des dommages directs ou indirects résultant d'une installation, d'un raccordement ou d'une utilisation incorrecte du produit.

Pour toute demande de bénéfice de la garantie et de réparation ou remplacement d'un article, contacter votre revendeur.

Le retour de l'équipement en usine ne sera accepté qu'avec notre accord préalable.

Les pièces d'usure ne sont pas couvertes par la garantie.

Pièces d'usure : joints et revêtement des plaques de la cellule

LIMITED WARRANTY

All HAYWARD products are covered for manufacturing defects or material defects for a warranty period of **2 years** as of date of purchases. Any warranty claim should be accompanied by evidence of purchase, indicating date of purchase. We would therefore advise you to keep your invoice.

The HAYWARD warranty is limited to repair or replacement, as chosen by HAYWARD, of the faulty products, provided that they have been subjected to normal use, in compliance with the guidelines given in their user guides, provided that the products have not been altered in any way, and provided that they have been used exclusively with HAYWARD parts and components. The warranty does not cover damage due to frost and to chemicals. Any other costs (transport, labour, etc.) are excluded from the warranty.

HAYWARD may not be held liable for any direct or indirect damage resulting from incorrect installation, incorrect connection, or incorrect operation of a product.

In order to claim on a warranty and in order to request repair or replacement of an article, please ask your dealer.

No equipment returned to our factory will be accepted without our prior written approval.

Wearing parts are not covered by the warranty.

Wear parts are : gasket and plate coating of cell

GARANTÍA LIMITADA

Todos los productos HAYWARD están cubiertos contra defectos de fabricación o del material por un periodo de garantía de **2 años** a partir de la fecha de la compra. Cualquier reclamación de garantía debe acompañarse de una prueba de compra, que indique la fecha de compra. Por consiguiente, le aconsejamos que conserve su factura.

La garantía HAYWARD está limitada a reparaciones o sustituciones, a juicio de HAYWARD, de los productos defectuosos, siempre que hayan sido sometidos a un uso normal, de acuerdo con las directrices ofrecidas en sus guías de usuario, y siempre que los productos no hayan sido alterados de ninguna forma, y que se hayan utilizado exclusivamente con piezas y componentes HAYWARD. La garantía no cubre averías debidas a congelaciones o productos químicos. Cualquier otro coste (transporte, mano de obra, etc.) está excluido de la garantía.

HAYWARD puede no asumir ninguna responsabilidad por cualquier avería directa o indirecta derivada de la instalación, conexión u operación incorrecta de un producto.

Para realizar una reclamación sobre la garantía y para solicitar la reparación o sustitución de un artículo, pregunte a su concesionario.

No se admitirá ninguna devolución de equipos a nuestra fábrica sin nuestra aprobación previa por escrito.

La piezas sometidas a desgaste no están cubiertas por la garantía.

Las piezas de desgaste son: las juntas y el revestimiento de las placas de la célula