

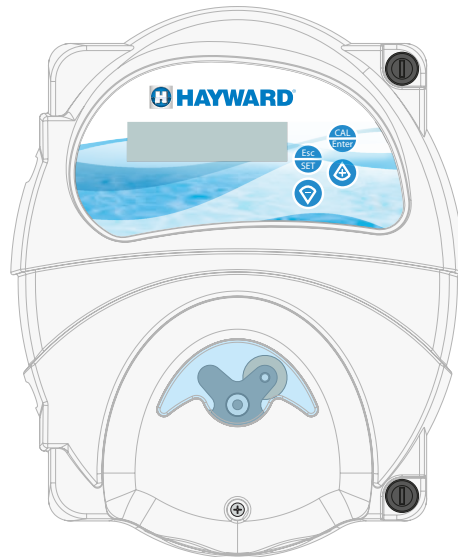

# HAYWARD®

## E-Z-PH



**INSTALLATION MANUAL**

**HANDBUCH**

**MANUAL DE INSTALACION**

**MANUEL D'INSTALLATION**

**MANUALE D'INSTALLAZIONE**



Hayward is a registered trademark of Hayward Industries, Inc.  
© 2011 Hayward Industries, Inc.

# PH regulator - EZ PH

## Package contents

- A) "EZ PH" regulator
- B) PVC Cristal suction tube Ø 4x6 (4 m)
- C) PE delivery tube Ø 4x6 (5 m)
- D) Fastening bracket kit
- E) Foot filter (PVC)
- F) Injection valve (3/8" GAS)
- G) pH electrode SPH-1
- H) PSS3 probe holder (1/2" GAS)
- I) Stop collar for securing probe holder and injection valve (φ=50 mm)
- L) Buffer solution kit pH 4, pH 7, H<sub>2</sub>O
- M) Reducer for injection valve

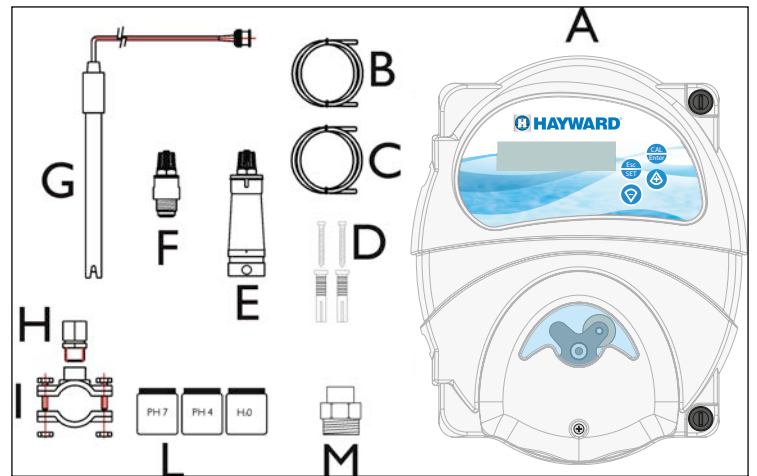

## TECHNICAL SPECIFICATIONS

Dimensions (H – L – D)	234x162x108 mm
Weight	1 kg
Power supply	230 VAC
Power	12 W or 18 W
Pump outlet	1.5 l/h
Maximum back pressure	1.5 bar
Pump status	Pause - On
Measuring scale	- 14.0 pH 0 to +1000 mV
Measuring precision	± 0.1 pH; ±10 mV
Measuring accuracy	± 0.02 pH; ±2 mV
Electrode calibration	Automatic

## Wall mounting

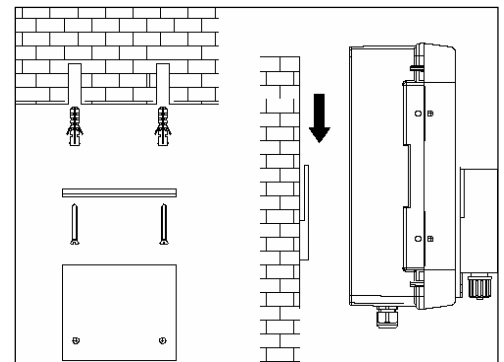

## ATTENZIONE / WARNING / ATTENTION / ACHTUNG

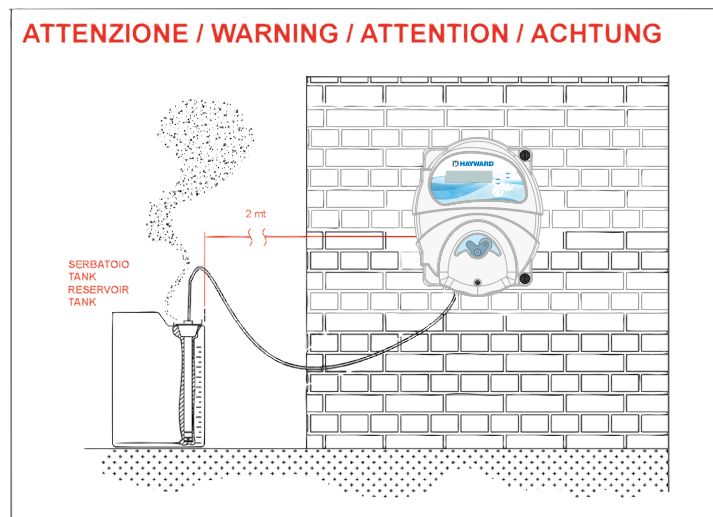

Presentation of the simplified menu - QUICK START page 1

Language selection

Tm25°C 6.5pH



Setup

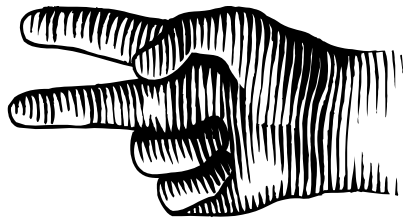

Configuration parameters



Pump config.  
pH mode



Enter/Confirm



Edit

enter pH mode



flow  
off



Enter/Confirm



Edit

change to on



language  
French



Enter/Confirm



Edit

change language

Presentation of the simplified menu - QUICK START page 2

Adjusting the pH setpoint

Tm25°C 6.5pH



keep pressed

Sp 7.0 pH  
Tm2 5.0pH

The pH value flashes



to adjust

Sp 7.0 pH  
Tm2 5.0pH

Adjustment from 1 to 14

Priming the dosing pump



press and hold

Exit the program



Exit  
Save

Flashes



Edit



Confirm

Presentation of the simplified menu - QUICK START page 3

Calibrating the probe

Tm25°C 6.5pH

 press and hold

Calibrating the pump

Release the  key

B.Sol 7 pH  
Press CAL

Flashes

Wait 60s  
B.Sol 7pH



Flashes

Wait 60s

Quality 100%  
Tamp sol 7pH

End on page 9

## COMPLETE PRESENTATION - CONFIGURING THE PARAMETERS

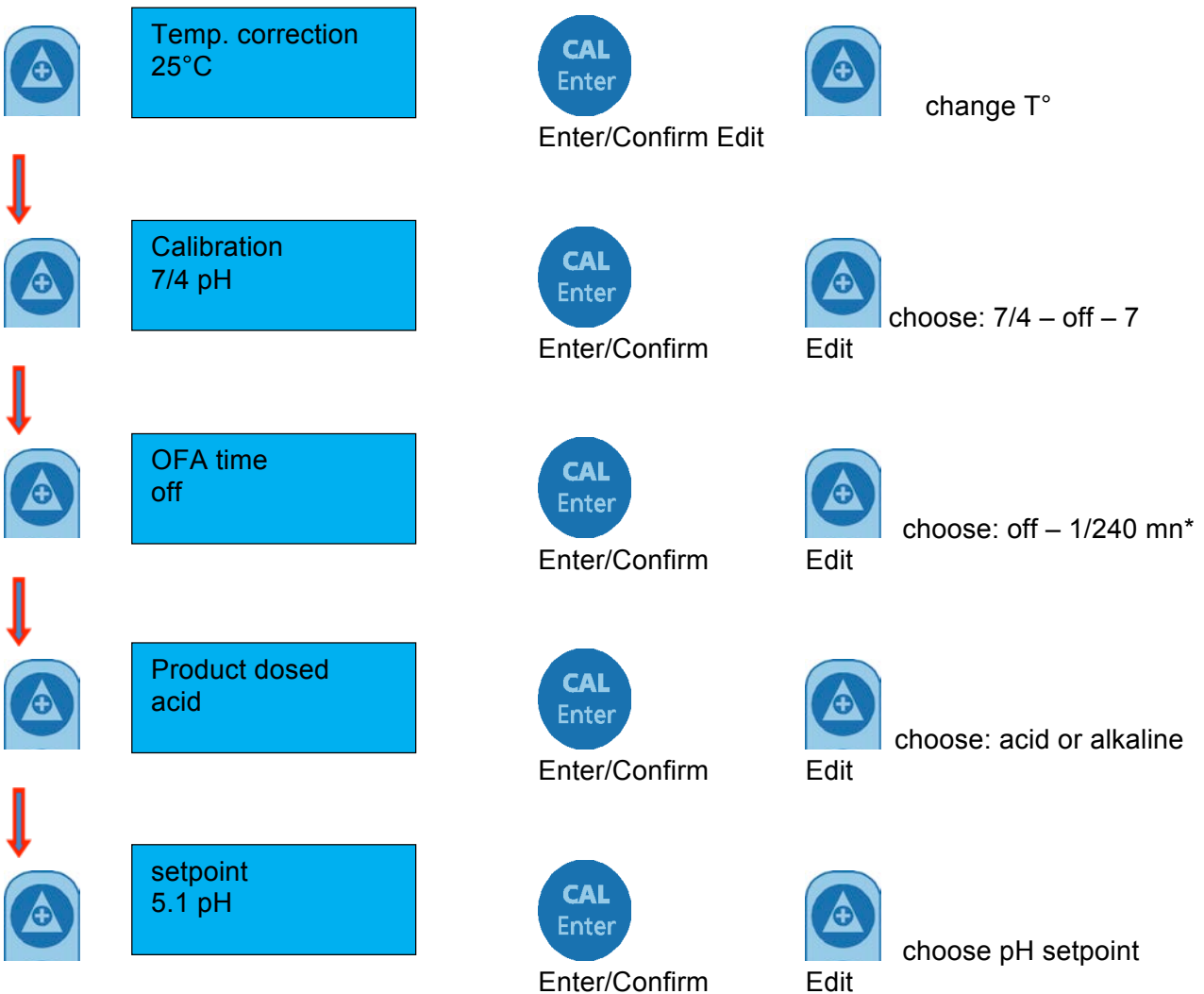
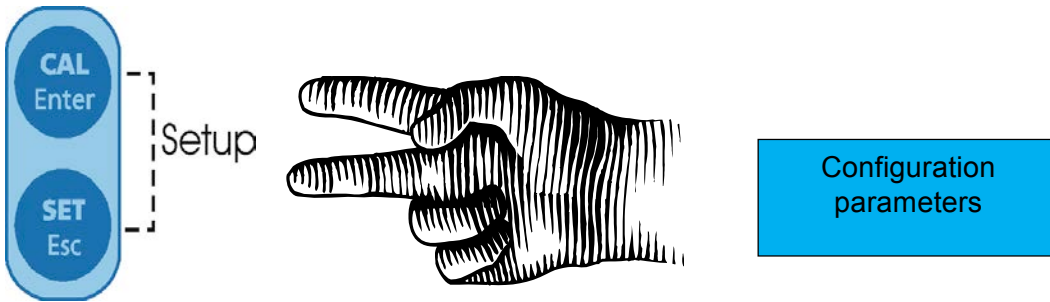

- OFA = Over Feed Alarm = Alarm used to stop the injection of pH if the setpoint remains unchanged for x min

# COMPLETE PRESENTATION - CONFIGURING THE PARAMETERS

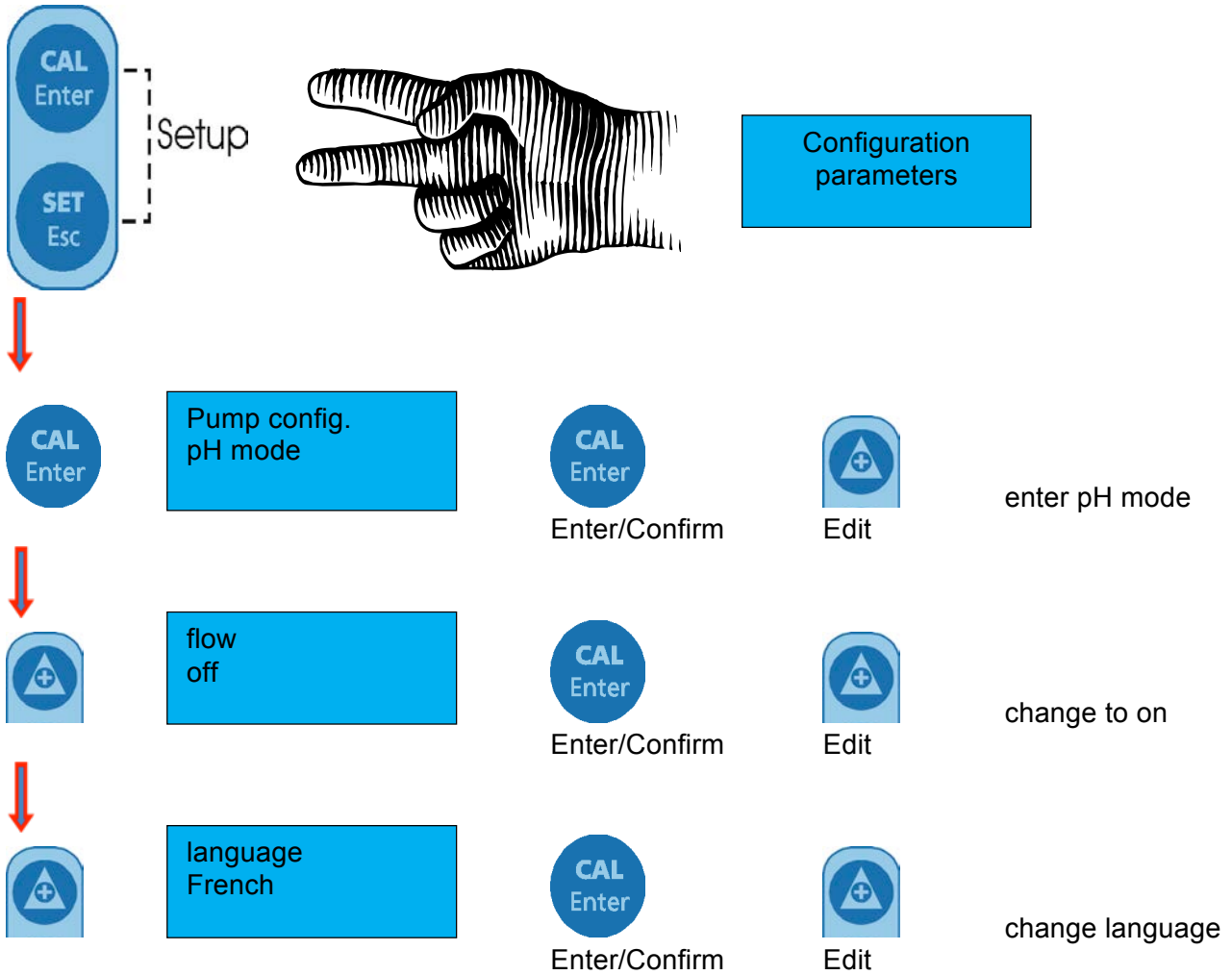



COMPLETE PRESENTATION - CONFIGURING THE PARAMETERS

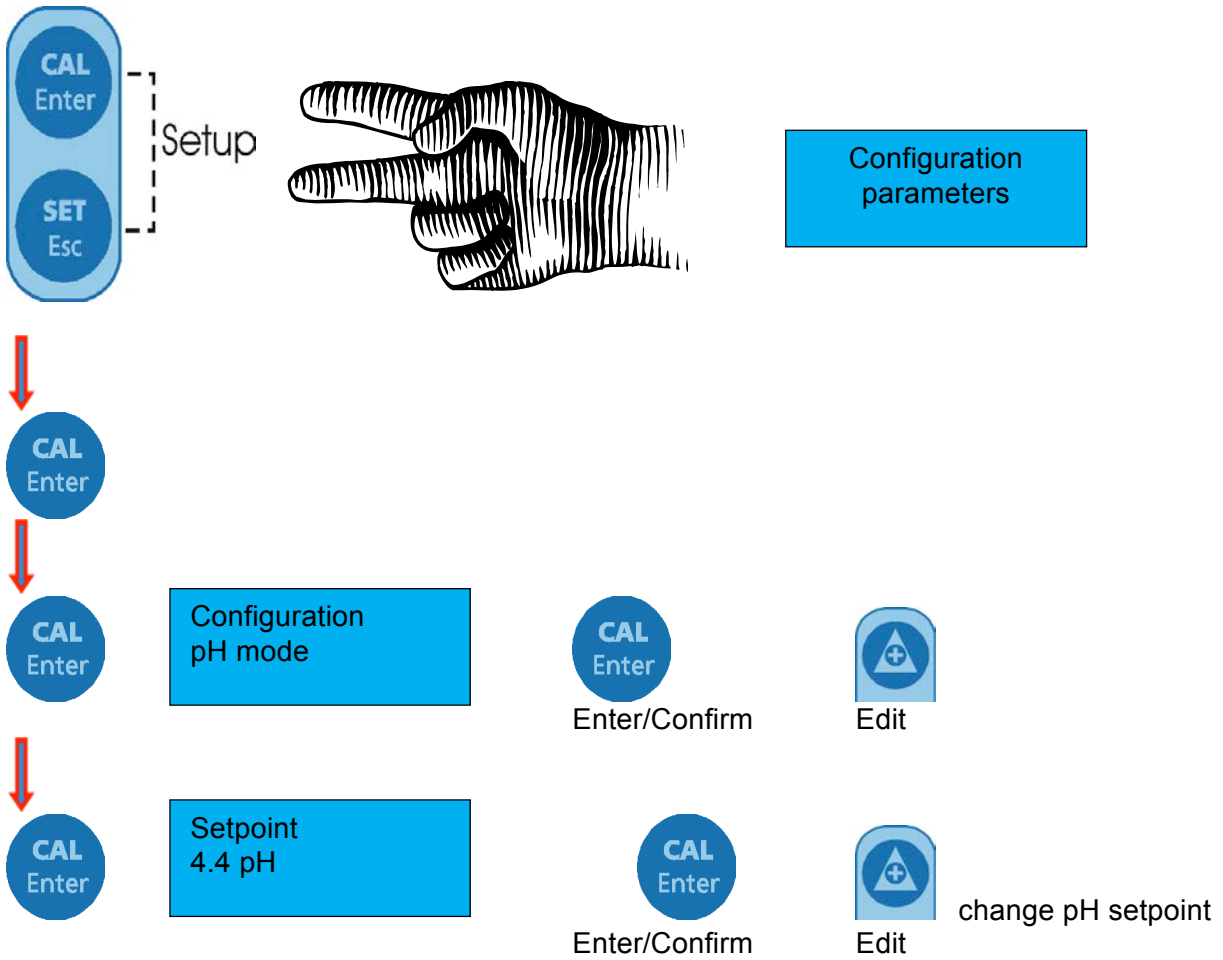





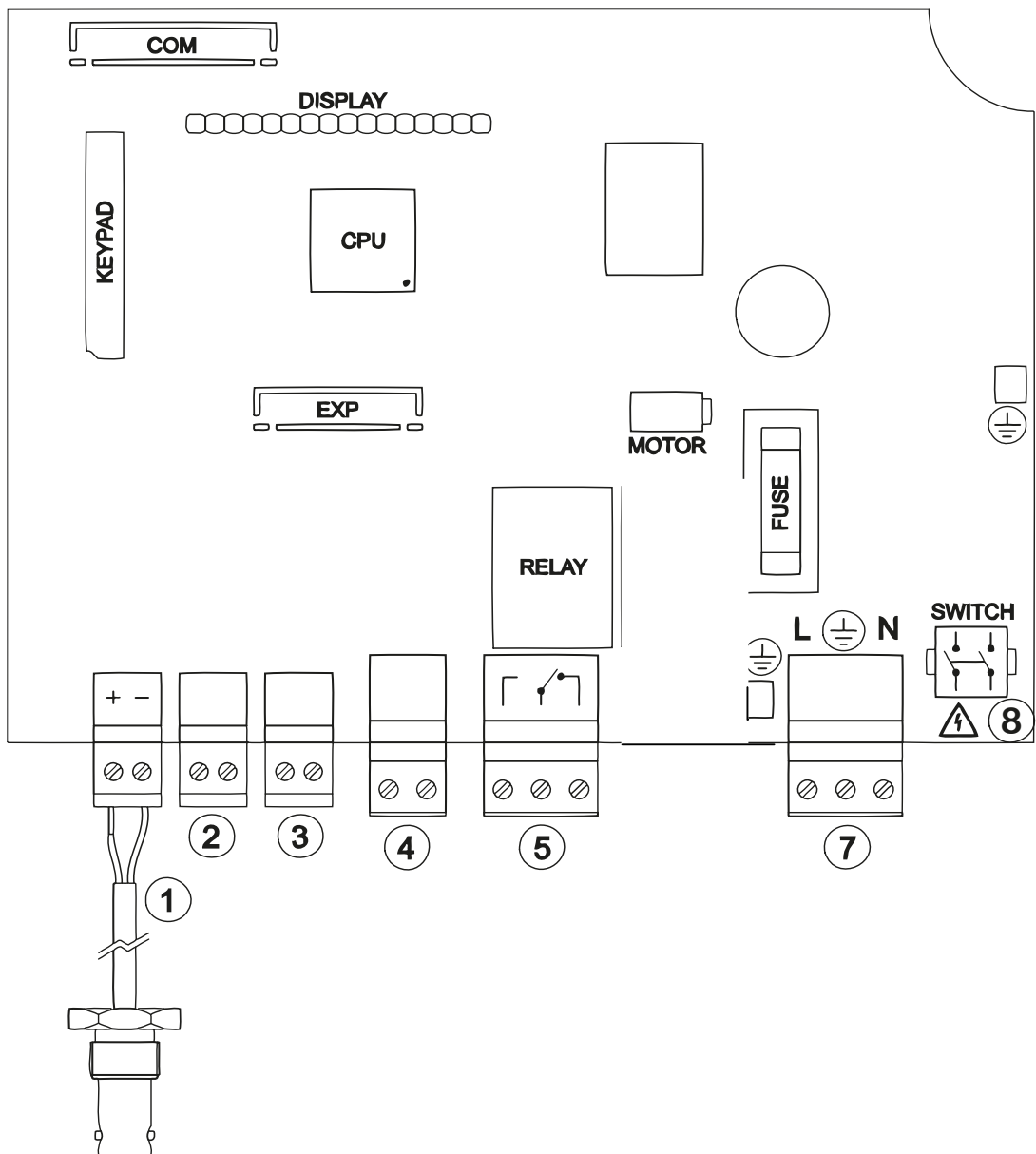



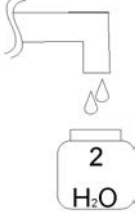

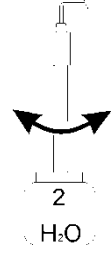
## CONNECTIONS

- 1) pH probe input
- 2) Temperature probe input (PT100 not supplied)
- 3) Level probe input (Product in container)
- 4) Flow input, recirculation pump flow (electrical signal 230 V ~.)
- 5) Remote alarm relay output (free contact, 250 V ~ 10 A resistive relay)
- 7) Power supply 230 V~ 50 Hz.
- 8) Power switch (in the top right corner of the control unit)

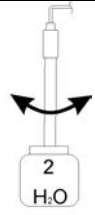

## pH PROBE CALIBRATION

 <p><b>1</b></p>	 <p><b>2</b></p>	 <p><b>3</b></p> <p>Wash the probe</p>
 <p><b>4</b></p> <p>Store the probe in the buffer solution</p>	<p><b>CALIBRATION</b></p>  <p>Press the CAL key for 3 seconds</p> <p><b>5</b></p>	<p><b>7PH PRESS CAL</b></p>  <p>Calibration requires one minute.</p> <p><b>WAIT 60S</b></p> <p><b>6</b></p>
<p><b>7PH QUALITY 100%</b></p> <p>Probe quality</p> <p><b>7</b></p>	 <p><b>8</b></p> <p>Wash the probe</p>	 <p><b>9</b></p> <p>Store the probe in the buffer solution</p>
<p><b>4PH PRESS CAL</b></p>  <p>Calibration requires one minute.</p> <p><b>WAIT 60S</b></p> <p><b>10</b></p>	<p><b>4PH QUALITY 100%</b></p> <p>Probe quality</p> <p><b>11</b></p>	 <p><b>12</b></p> <p>Wash the probe</p>
 <p><b>13</b></p>	 <p>Press the CAL key to exit and save the data</p> <p><b>14</b></p>	<p>Normal state of measurement and control</p> <p><b>15</b></p>

**N.B.**

If we set the Calibration function = 7 pH, the system performs calibration for the 7 pH point only.

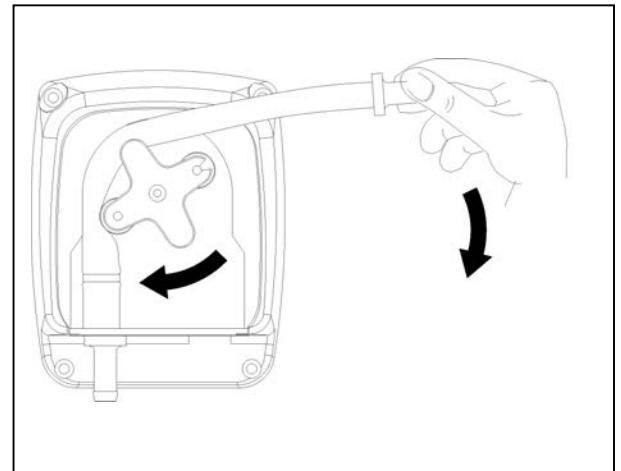
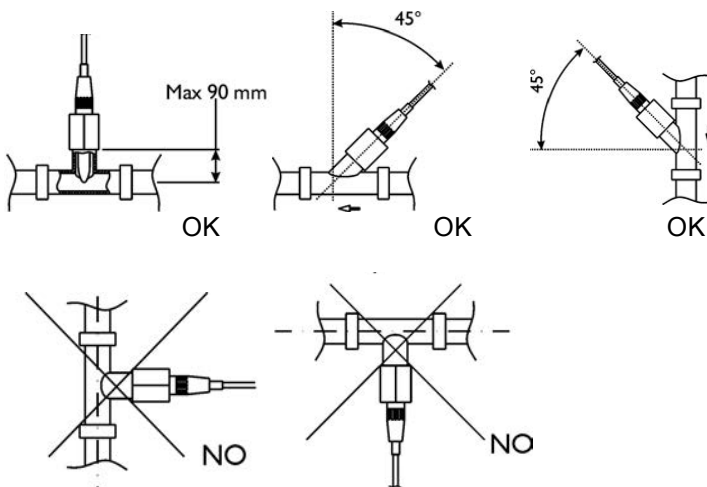
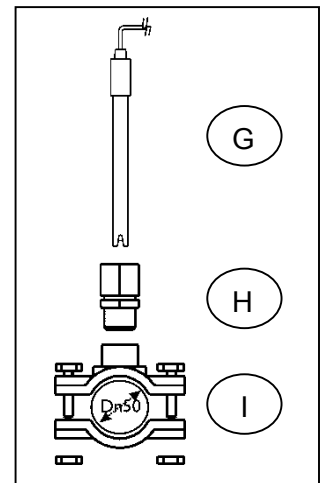
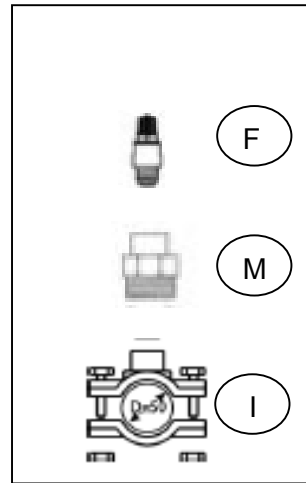
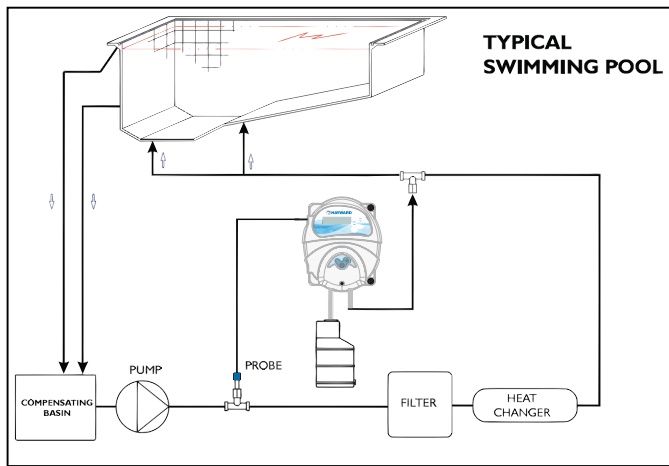

Alarm	Screen	Relay	Actions
Level	LEVEL 7.2 PH	Relay closed alarm	- Press the Enter key to disable the alarm remotely - Restore the level of product in the container
OFA First Alarm (Time >70%)	OFA ALARM 7.2 PH	Relay open alarm	- Press the Enter key to disable the alarm
OFA Second Alarm (Time = 100%)	STOP OFA 7.2 PH	Relay closed alarm	- Press the Enter key to disable the alarm
Water flow (recirculation pump off)	FLOW 7.2 PH	Relay open alarm	- Reactivate the water recirculation pump.
System error	PARAMETER ERROR	Relay open alarm	- Press Enter to restore the default parameters - Damage to the system
Calibration function	ERROR 7 PH ERROR 4 PH	Relay open alarm	- Replace the probe or the buffer solution and repeat calibration

**Factory parameters:**

- Language = **FR (French)**
- Setpoint = **Acid**
- Dosing method = **Acid**
- OFA time (overload alarm) = **OFF**
- Calibration = **7/4 (2 points)**
- Flow input = **ON**

**To restore the default parameters, proceed as follows:**

- Shut down the Basic system
- Start up the Basic system by holding down the UP and DOWN arrow keys.
- The system will show **INIT.DEFAULT NO**
- Press the UP arrow  
**INIT.DEFAULT YES**
- Press Enter to restore the parameters.

# PH-Regler - EZ PH

## Lieferumfang

- A) "EZ PH" Regler
- B) Ansaugleitung PVC Cristal Ø 4x6 (4 m)
- C) Druckleitung PE Ø 4x6 (5 m)
- D) Montageset
- E) Bodenfilter (PVC)
- F) Einspritzventil (3/8" GAS)
- G) pH-Elektrode SPH-1
- H) Sondenhalterung PSS3 (1/2" GAS)
- I) Abweigschelle für die Befestigung von Sondenhalterung und Einspritzventil ( $\phi=50$  mm)
- L) Pufferlösung pH 4, pH 7, H<sub>2</sub>O
- M) Reduzierstück für Einspritzventil

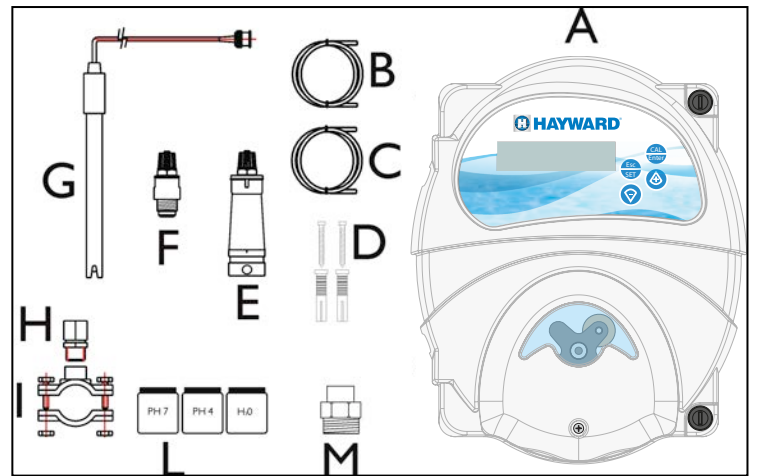

## TECHNISCHE SPEZIFIKATION

Abmessungen (H – L – T)	234x162x108 mm
Gewicht	1 Kg
Versorgung	230 VC.A
Leistung	12 W oder 18 W
Pumpenausgang	1,5 l/h
Maximaler Gegendruck	1,5 bar
Status der Pumpe	Pause - Einschalten
Messskala	0 ÷ 14,0 pH 0 ÷ +1000 mV
Messpräzision	± 0,1 pH; ±10 mV
Messgenauigkeit	± 0,02 pH; ±2 mV
Kalibrierung der Elektrode	Automatisch

## Wandmontage

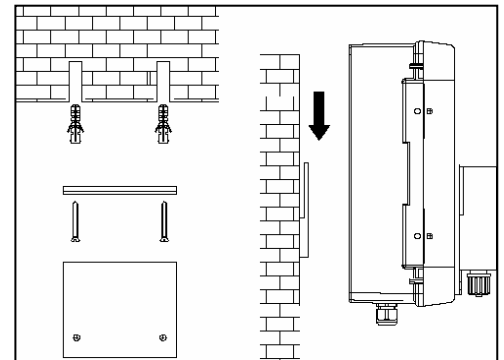

## ATTENZIONE / WARNING / ATTENTION / ACHTUNG

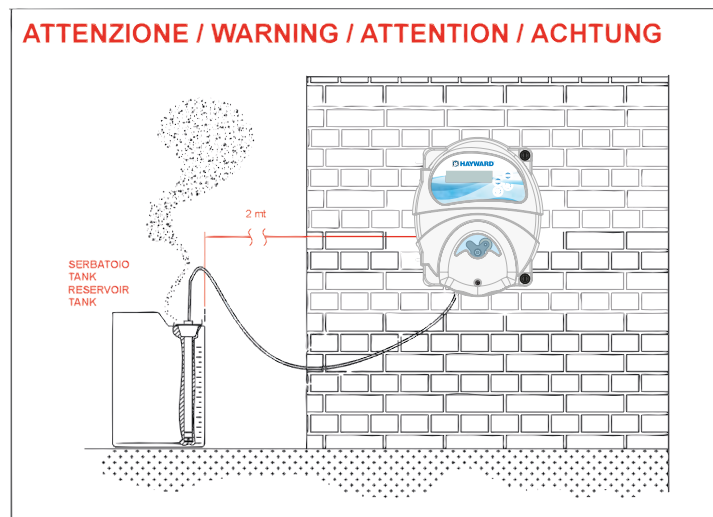

Sprachwahl

Tm25°C 6,5pH



Setup

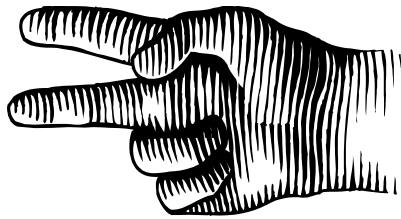

Einstellungsparameter



Pumpenkonfig.  
pH-Modus



Eingabe/Bestätigung Bearbeiten

pH-Modus eingeben



Förderleistung  
off



Eingabe/Bestätigung Bearbeiten

auf on ändern



Sprache  
französisch



Eingabe/Bestätigung Bearbeiten

Sprache ändern

## Präsentation des vereinfachten Menüs - QUICK START Seite 2

### Einstellung des pH-Sollwerts

Tm25°C 6,5pH



gedrückt halten

Sp 7.0 pH  
Tm2 5.0pH

pH-Wert blinkt



zur Einstellung

Sp 7.0 pH  
Tm2 5.0pH

Einstellung von 1 bis 14

### Ansaugen Dosierpumpe



lange drücken

### Programm verlassen



Verlassen  
Speichern

Blinkt



Bearbeiten

Bestätigen

Sondenkalibrierung

Tm25°C 6,5pH

 lange drücken

Pumpenkalibrierun  
g

Taste  auslassen

Lös. B. 7 pH  
CAL drücken

Blinkt

Warten 60  
B.Sol 7pH



Blinkt

Zählung 60s abwarten

Qualität 100%  
Pufferlösung 7pH

Weiter auf Seite 9



## UMFASSENDE PRÄSENTATION - PARAMETERKONFIGURATION

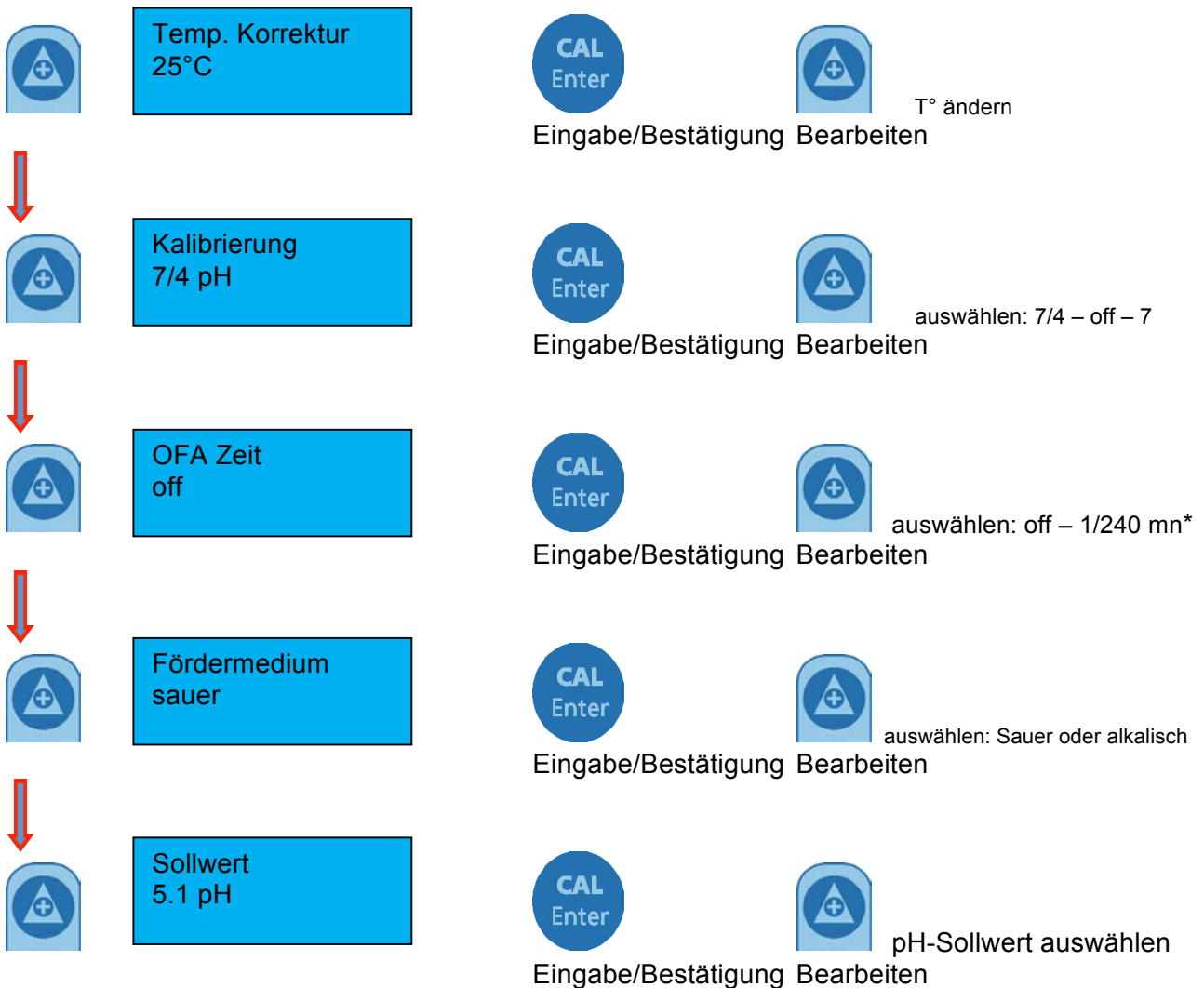

- OFA = Over Feed Alarm = Alarm, der die pH-Einspritzung stoppt, falls der Sollwert x Min. lang unverändert bleibt

# UMFASSENDE PRÄSENTATION - PARAMETERKONFIGURATION

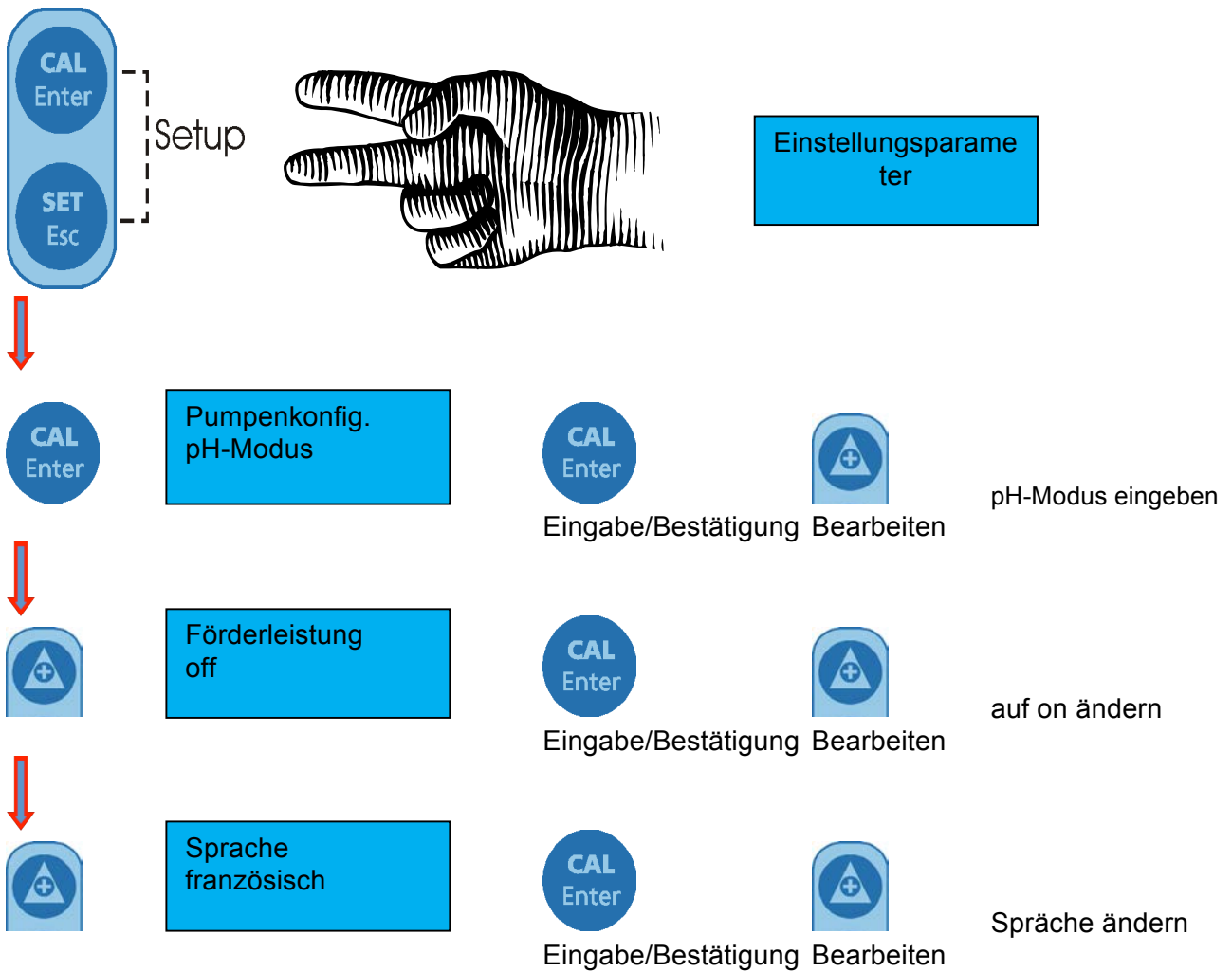

# UMFASSENDE PRÄSENTATION - PARAMETERKONFIGURATION

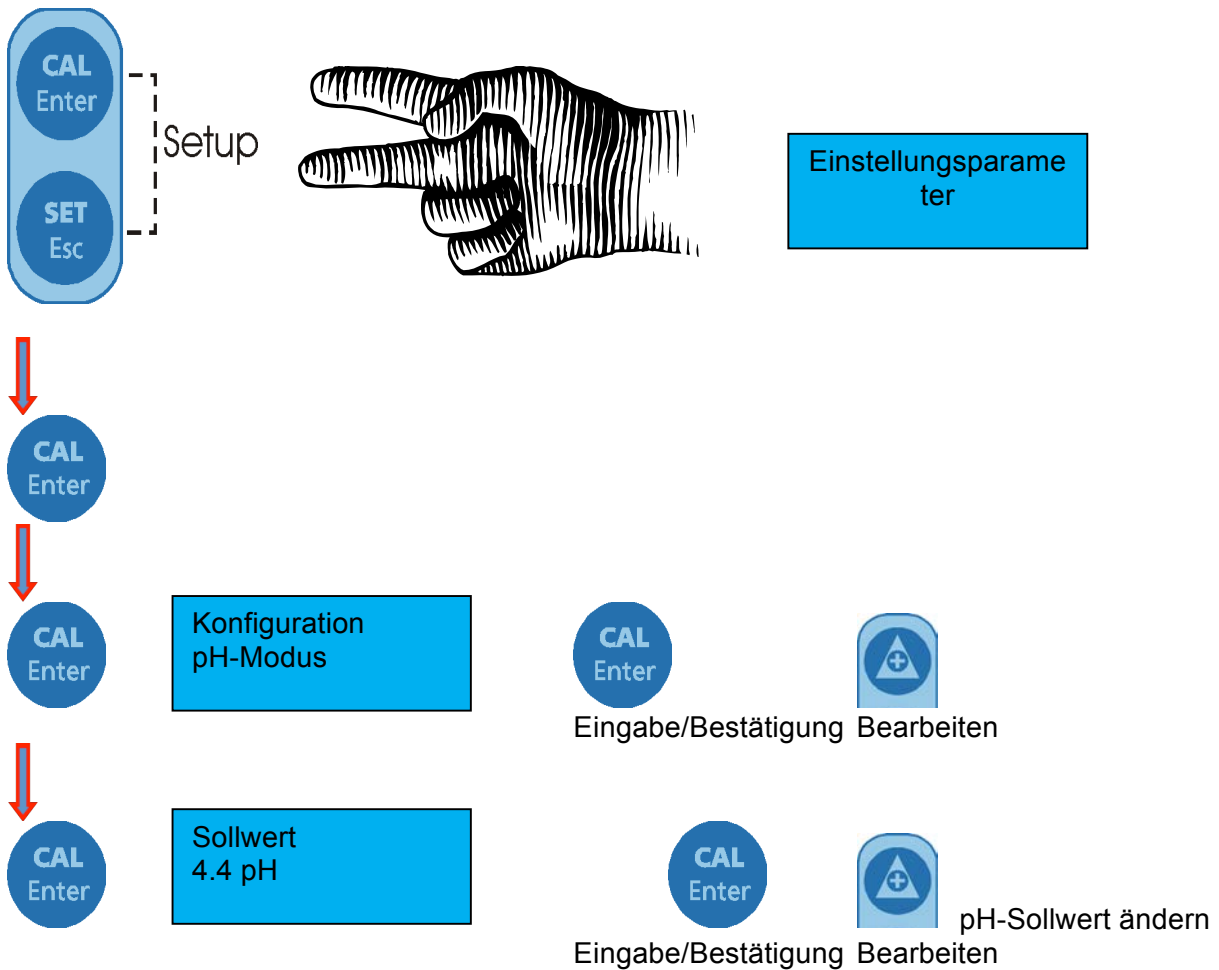





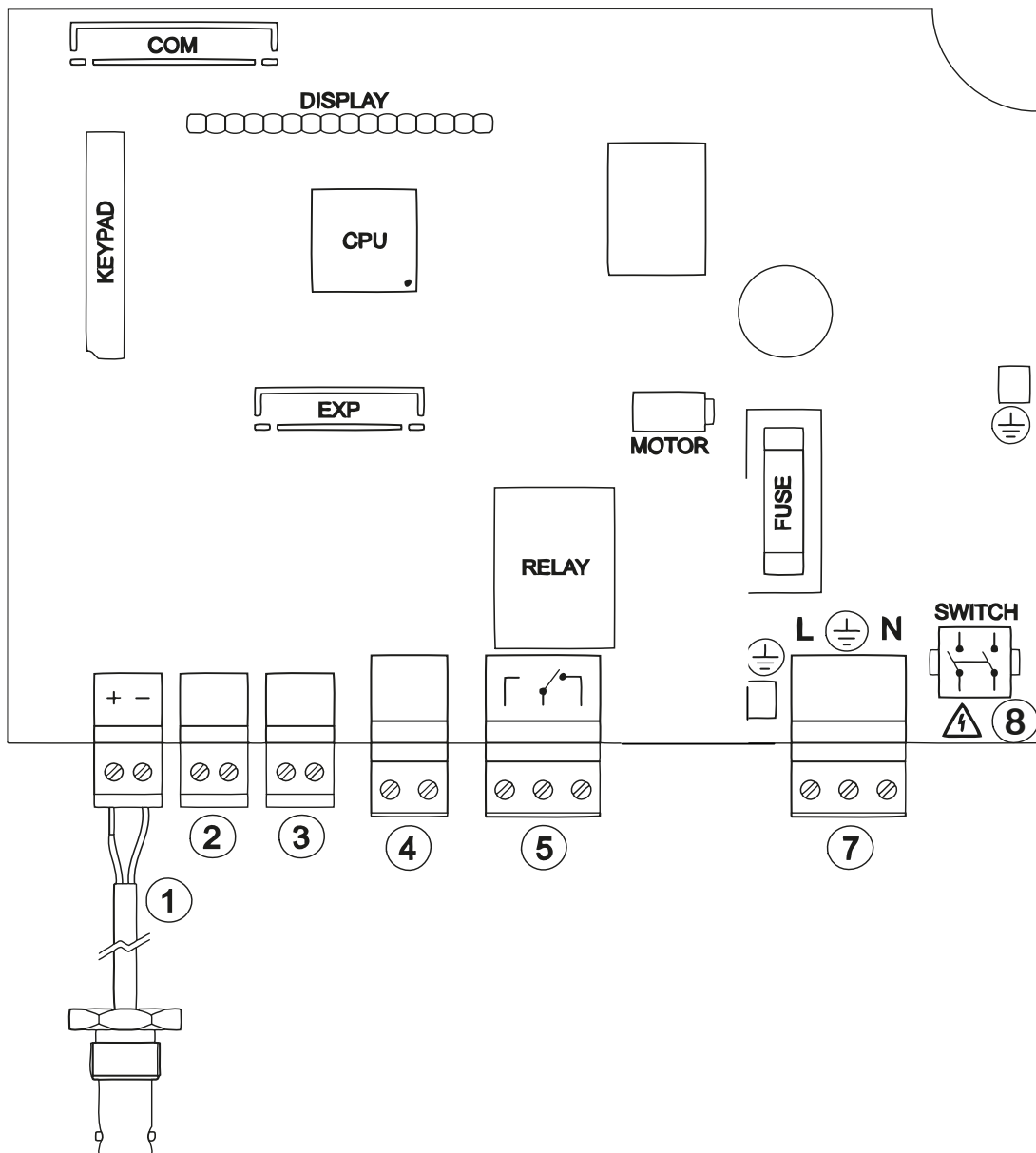



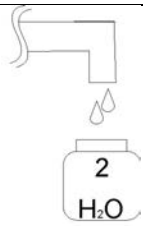

## ANSCHLÜSSE

- 1) Eingang pH-Sonde
- 2) Eingang Temperatursonde (PT100 nicht Teil des Lieferumfangs)
- 3) Eingang Füllstandssonde (Fördermedium im Behälter)
- 4) Flow Eingang, Förderleistung Rückführungspumpe (elektrisches Signal 230 V ~.)
- 5) Relaisausgang Fernalarm (freier Kontakt, Relais250 V ~ 10 A resistiv)
- 7) Versorgung 230 V~ 50 Hz.
- 8) Trennschalter (befindet sich an der Steuerung oben rechts)

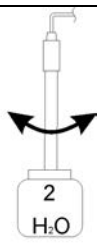
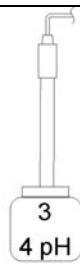

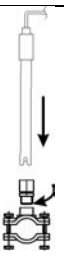
## KALIBRIERUNG pH-SONDE

 <p><b>1</b></p>	 <p><b>2</b></p>	 <p><b>3</b></p> <p>Sonde spülen</p>
 <p><b>4</b></p> <p>Sonde in der Pufferlösung aufbewahren</p>	<p><b>KALIBRIERUNG</b></p>  <p>Taste CAL 3 Sekunden lang drücken</p> <p><b>5</b></p>	<p><b>7PH CAL DRÜCKEN</b></p>  <p>Kalibrierung dauert eine Minute. <b>60 S WARTEN</b></p> <p><b>6</b></p>
<p><b>7PH QUALITÄT 100%</b></p> <p>Qualität der Sonde</p> <p><b>7</b></p>	 <p><b>8</b></p> <p>Sonde spülen</p>	 <p><b>9</b></p> <p>Sonde in der Pufferlösung aufbewahren</p>
<p><b>4PH CAL DRÜCKEN</b></p>  <p>Kalibrierung dauert eine Minute. <b>60 S WARTEN</b></p> <p><b>10</b></p>	<p><b>4PH QUALITÄT 100%</b></p> <p>Qualität der Sonde</p> <p><b>11</b></p>	 <p><b>12</b></p> <p>Sonde spülen</p>
 <p><b>13</b></p>	 <p>Vorgang durch Drücken von Taste Key verlassen und Daten speichern</p> <p><b>14</b></p>	<p>Normaler Mess- und Prüfstatus</p> <p><b>15</b></p>

**Hinweis:**

Bei Programmierung der Funktion Kalibrierung = 7 pH führt das System die Kalibrierung nur für Punkt 7 pH aus

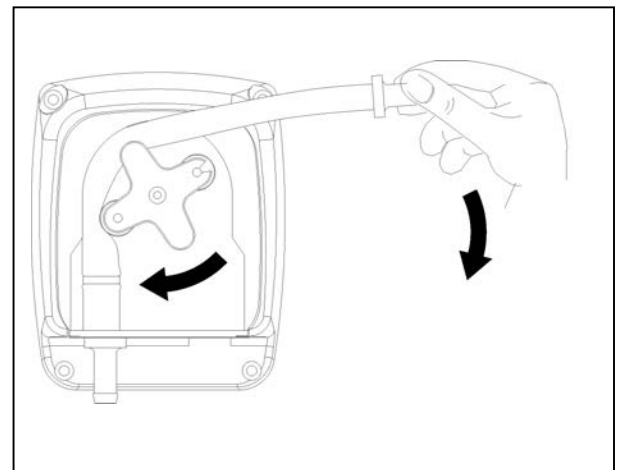
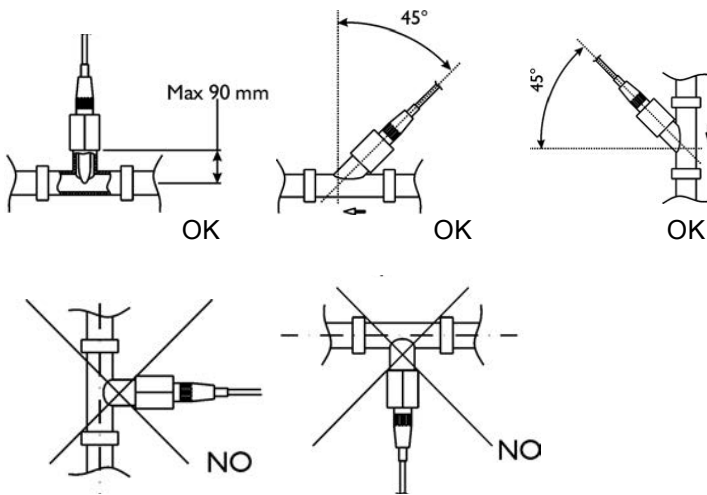
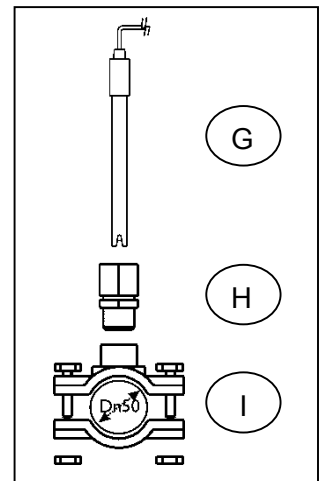
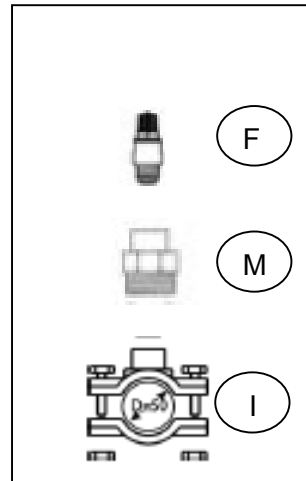
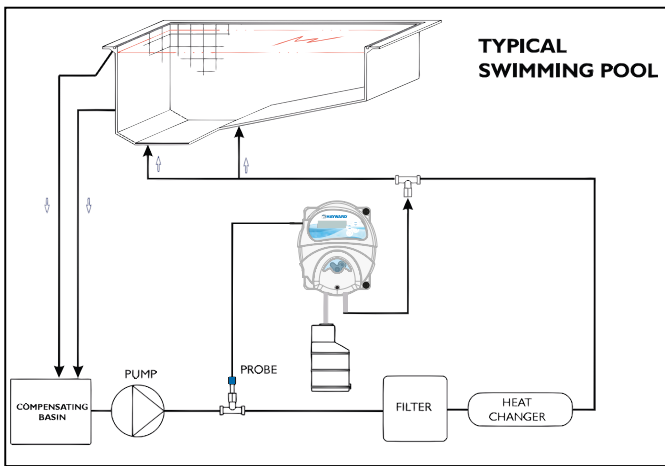

Alarm	Bildschirm	Relais	Maßnahmen
Level	LEVEL 7.2 PH	Alarmrelais geschlossen	- Enter drücken, um den Fernalarm zu deaktivieren - Korrekten Füllstands der Fördermediums im Behälter wiederherstellen
OFA Erster Alarm (Zeit >70%)	OFA ALARM 7.2 PH	Alarmrelais offen	- Enter drücken, um den Alarm zu deaktivieren
OFA Zweiter Alarm (Zeit=100%)	STOP OFA 7.2 PH	Alarmrelais geschlossen	- Enter drücken, um den Alarm zu deaktivieren
Wasser Fördermenge (Rückführungspumpe aus)	FÖRDERLEISTUNG 7.2 PH	Alarmrelais offen	- Rückführungspumpe reaktivieren.
Systemfehler	PARAMETER ERROR	Alarmrelais offen	- Enter drücken, um die Default-Parameter herzustellen - Systemschaden
Eichfunktion	FEHLER 7 PH FEHLER 4 PH	Alarmrelais offen	- Sonde oder Pufferlösung auswechseln und Kalibrierung wiederholen

**Werkseitige Parameter:**

- Sprache = **FR (Französisch)**
- Sollwert = **Sauer**
- Dosierungsmethode = **Sauer**
- OFA Zeit (Überlastalarm) = **OFF**
- Kalibrierung = **7/4 (2 Punkte)**
- Strömungseingang = **ON**

**Zur Wiederherstellung der Default-Parameter folgendermaßen vorgehen:**

- Basic System stoppen
- Basic System starten, dazu die Tasten AUF (UP) und AB (DOWN) betätigen.
- Das System zeigt an **INIT.DEFAULT NO**
- Taste AUF (UP) betätigen  
**INIT.DEFAULT YES**
- Enter drücken, um die Parameter wiederherzustellen.

# Regulador de PH - EZ PH

## Contenido de la caja

- A) Regulador "EZ PH"
- B) Tubo de aspiración PVC Cristal Ø 4x6 (4 m)
- C) Tubo de envío PE Ø 4x6 (5 m)
- D) Kit soporte de fijación
- E) Filtro de fondo (PVC)
- F) Válvula de inyección (3/8" GAS)
- G) Electrodo pH SPH-1
- H) Porta sonda PSS3 (1/2" GAS)
- I) Abrazadera con toma de derivación para la fijación del porta-sonda y válvula de inyección ( $\phi=50$  mm)
- L) Kit de solución tampón pH 4, pH 7, H<sub>2</sub>O
- M) Reductor para válvula de inyección

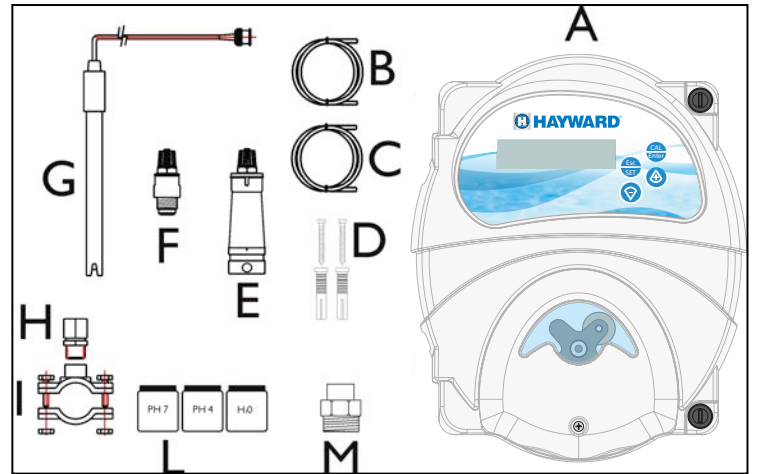

## ESPECIFICACIONES TÉCNICAS

Dimensiones (A – L – P)	234x162x108 mm
Peso	1 kg
Alimentación	230 VCA
Potencia	12 W o 18 W
Salida de la bomba	1,5 l/h
Contrapresión máxima	1,5 bar
Estado de la bomba	Pausa - Encendido
Escala de medida	0 ÷ 14,0 pH 0 ÷ +1000 mV
Precisión de medida	± 0,1 pH; ±10 mV
Exactitud de la medición	± 0,02 pH; ±2 mV
Calibración del electrodo	Automática

## Instalación en la pared

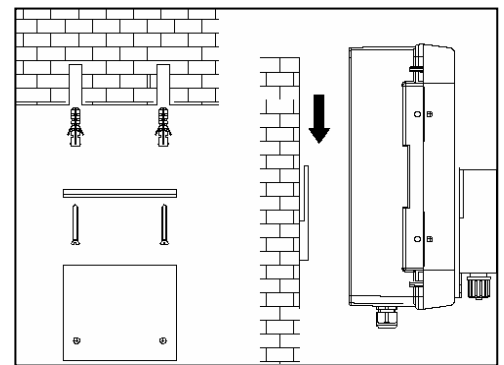

## ATTENZIONE / WARNING / ATENCIÓN / ACHTUNG

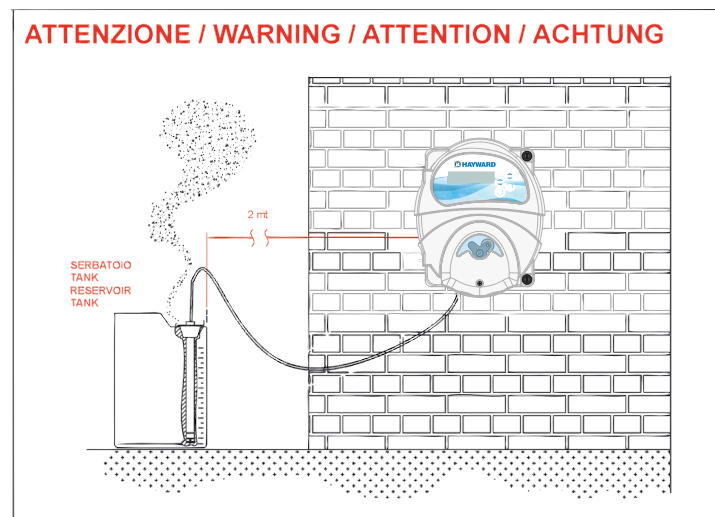

Selección del Idioma

Tm25°C 6,5pH



Setup

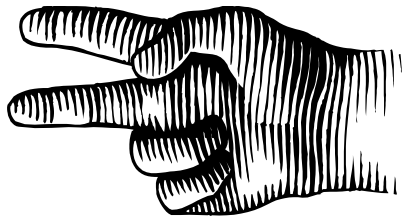

Parámetros de configuración



Config. bomba  
Modalidad pH



Ingresar/Confirmar



Modificar

ingresar modo pH



caudal  
OFF



Ingresar/Confirmar



Modificar

cambiar en on



Idioma  
francés



Ingresar/Confirmar



Modificar

cambiar idioma



## Presentación del menú simplificado - QUICK START página 2

### Regulación del punto de ajuste del pH

Tm25°C 6,5pH



mantener presionado

Esp 7.0 pH  
Tm2 5.0pH

El valor del pH parpadea



para la regulación

Esp 7.0 pH  
Tm2 5.0pH

Regulación de 1 a 14

### Activación bomba dosificadora



presionar de modo prolongado

### Salir del programa



Salir  
Guardar

Parpadea



Modificar



Confirmar

Presentación del menú simplificado - QUICK START página 3

Calibración de la sonda

Tm25°C 6,5pH

CAL  
Enter

presionar de modo prolongado

Calibración de la  
bomba

B.Sol 7 pH  
Pres CAL

Liberación de la tecla

CAL  
Enter

Parpadea

Esperar 60s  
B.Sol 7pH



Parpadea

Esperar el recuento de 60s

Calidad 100%  
Sol tamp 7pH

Terminar en la página 9

## PRESENTACIÓN COMPLETA - CONFIGURACIÓN DE LOS PARÁMETROS

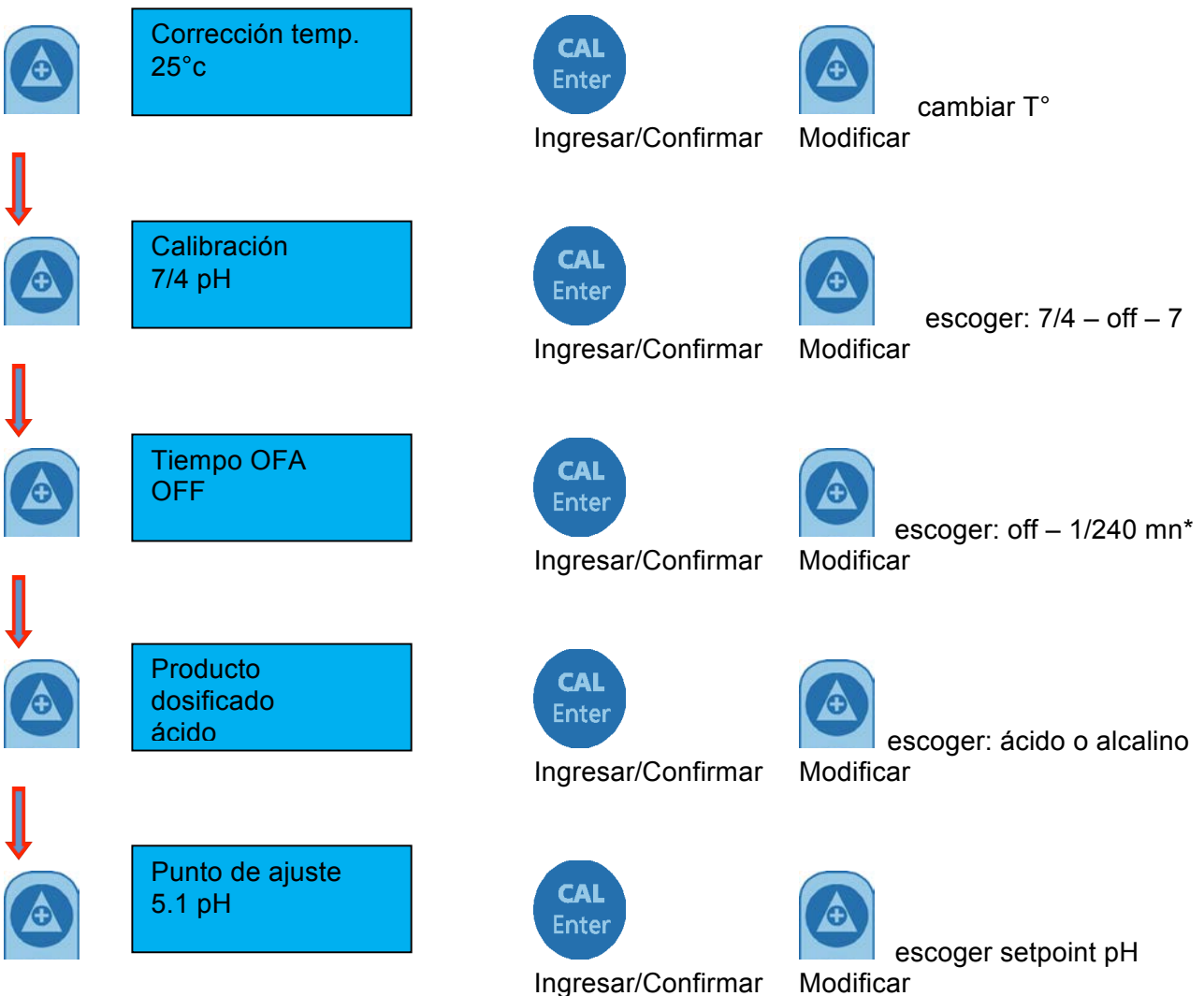
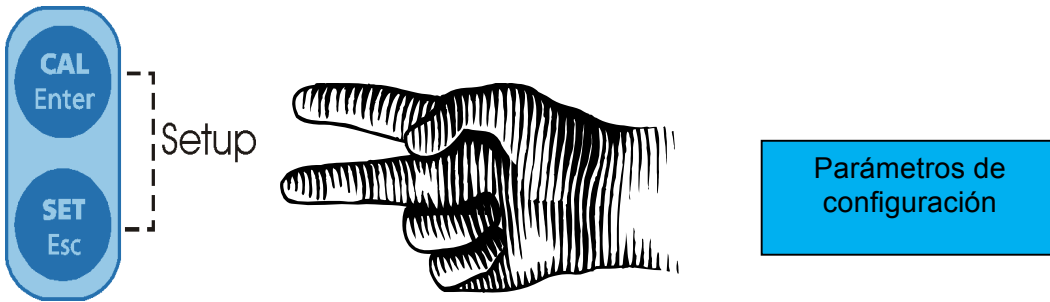

- OFA = Over Feed Alarm = Alarma empleada para parar la inyección de pH, si el punto de ajuste permanece inmutado por x min

## PRESENTACIÓN COMPLETA - CONFIGURACIÓN DE LOS PARÁMETROS

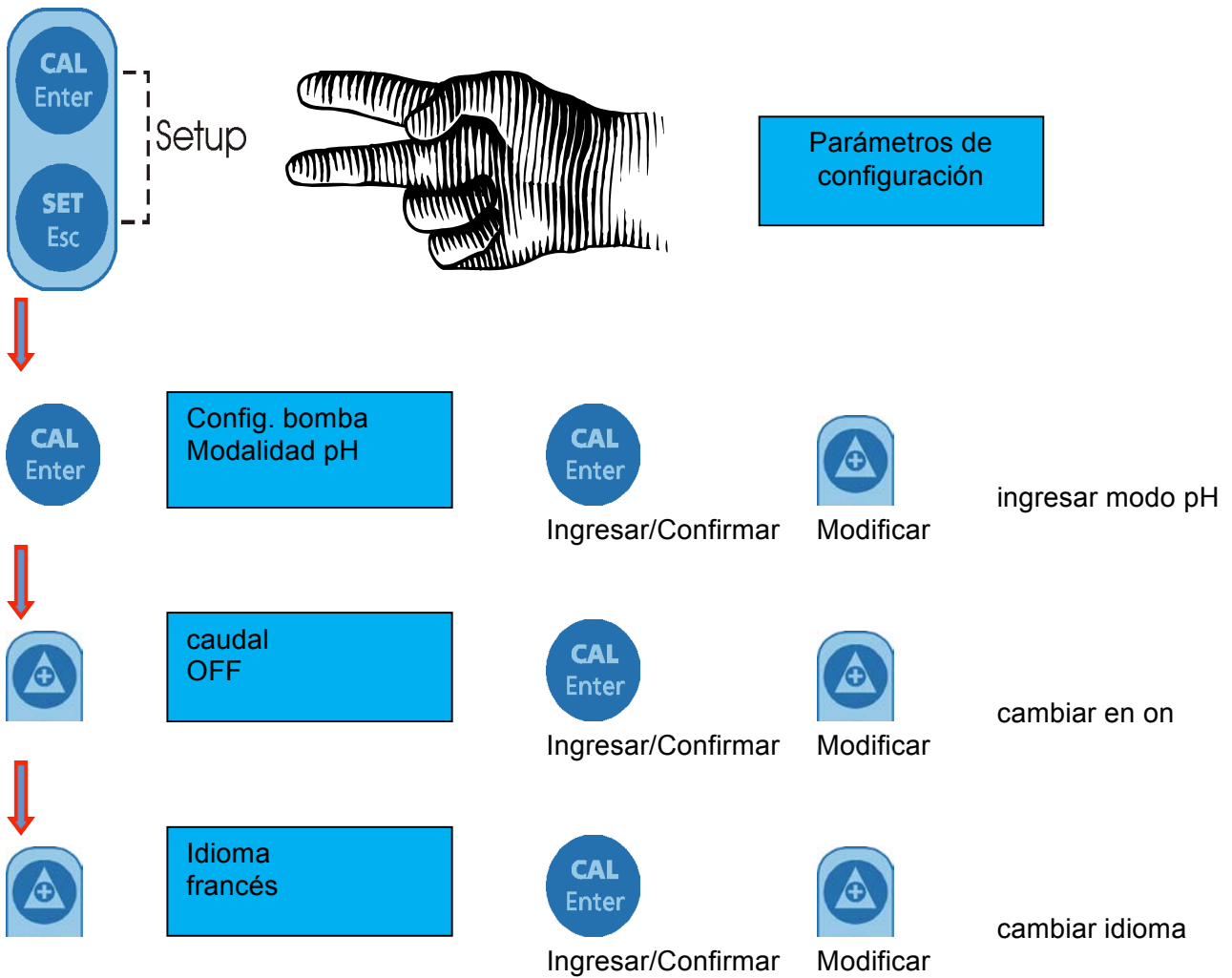

# PRESENTACIÓN COMPLETA - CONFIGURACIÓN DE LOS PARÁMETROS

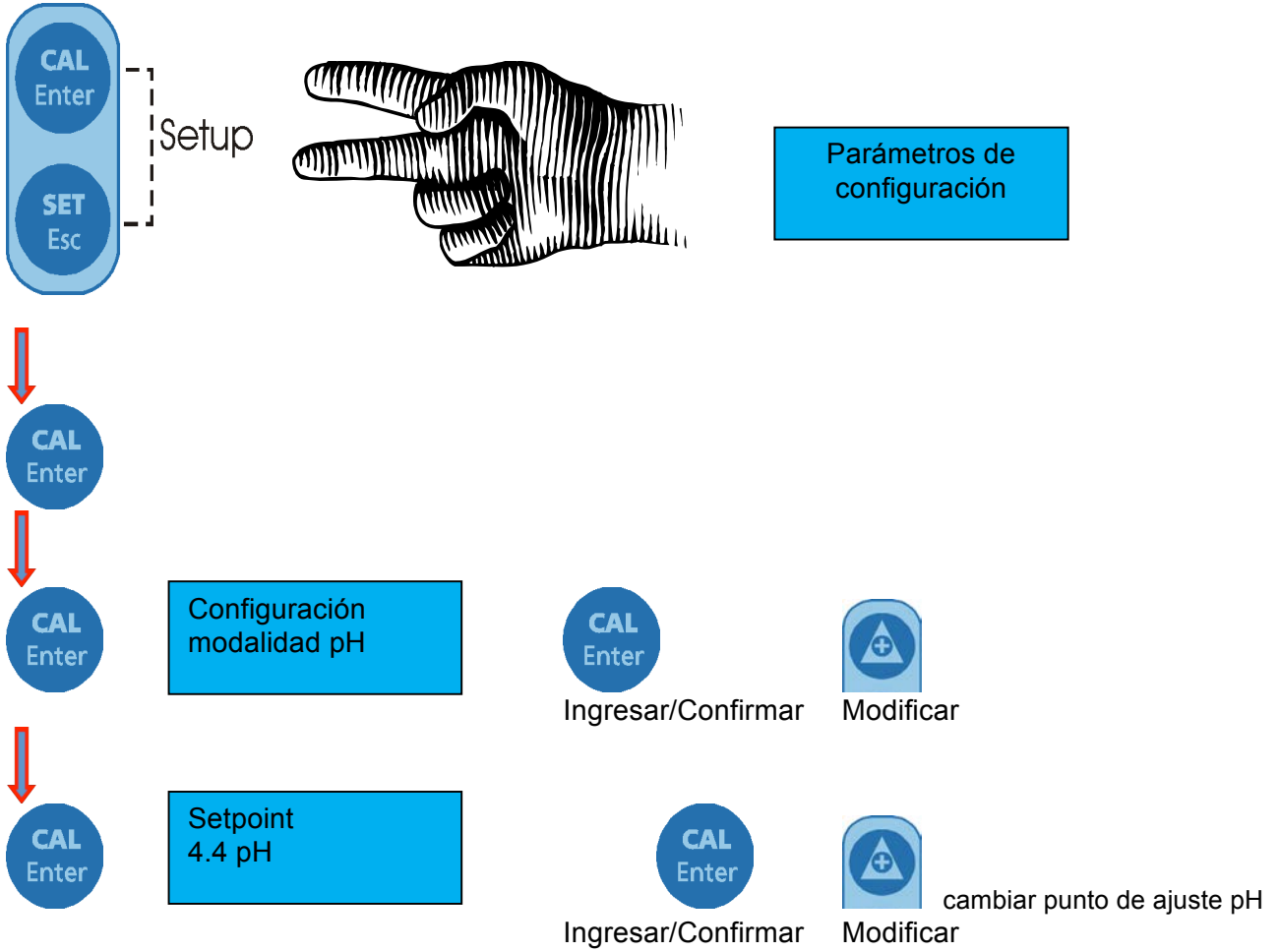





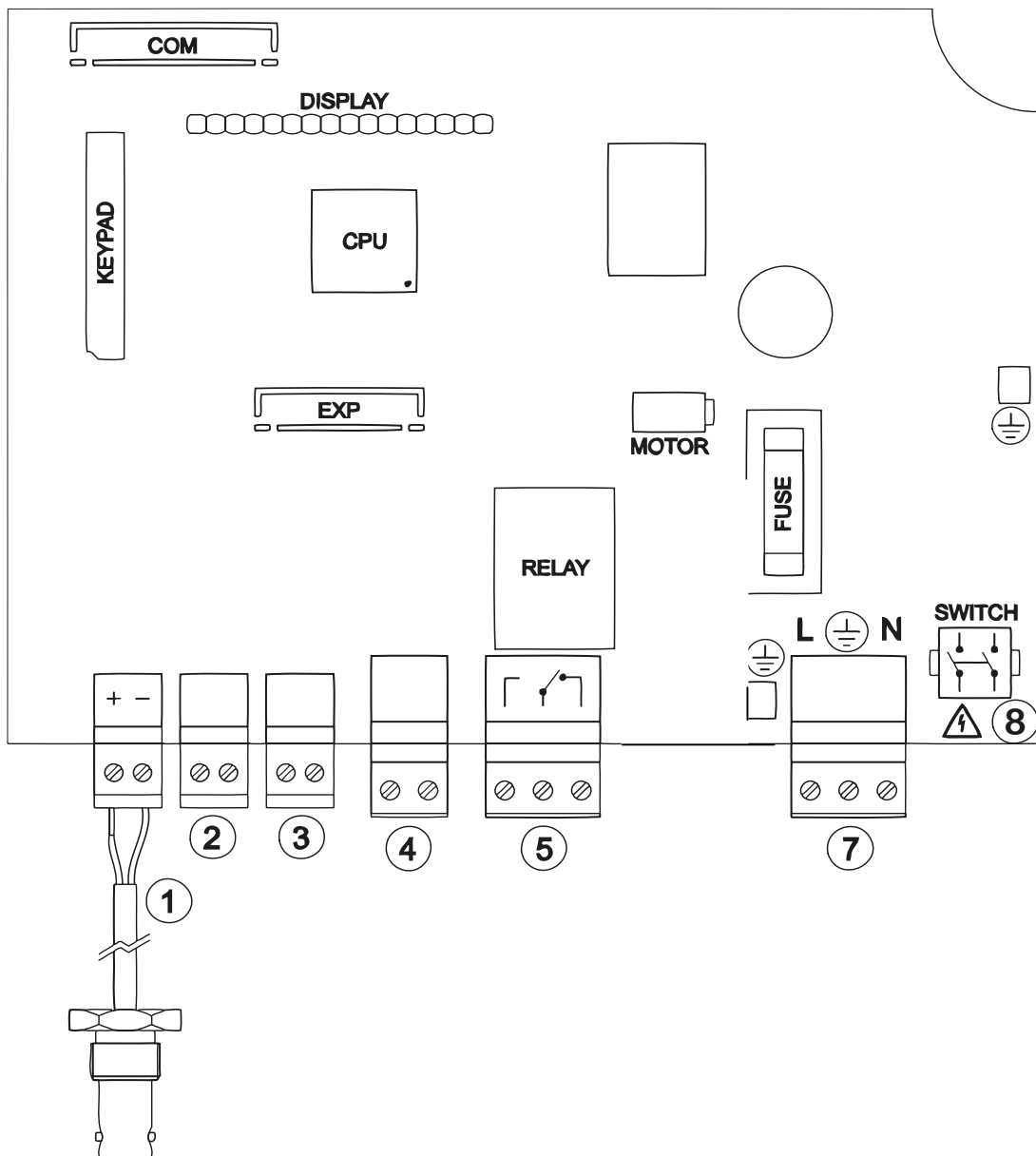



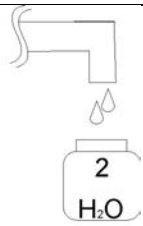

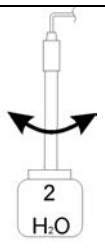

## CONEXIONES

- 1) Entrada sonda pH
- 2) Entrada sonda temperatura (PT100 no suministrada)
- 3) Entrada sonda de nivel (Producto en el contenedor)
- 4) Entrada Flow, caudal bomba de recirculación (señal eléctrica 230 V ~.)
- 5) Salida relé alarma a distancia (contacto libre, relé 250 V ~ 10 A resistivo)
- 7) Alimentación 230 V~ 50 Hz.
- 8) Interruptor de alimentación (situado arriba a la derecha de la centralita)

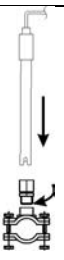

## CALIBRACIÓN SONDA pH

 <p>①</p>	 <p>②</p>	 <p>③</p> <p>Lavar la sonda</p>
 <p>④</p> <p>Conservar la sonda en la solución del tampón</p>	<p>CALIBRACION</p>  <p>Pulsar la tecla CAL durante 3 segundos</p> <p>⑤</p>	<p>7PX PRESIONAR CAL</p>  <p>La calibración requiere un minuto. <b>ESPERAR 60 S</b></p> <p>⑥</p>
<p>7PX CALIDAD 100%</p> <p>Calidad de la sonda</p> <p>⑦</p>	 <p>⑧</p> <p>Lavar la sonda</p>	 <p>⑨</p> <p>Conservar la sonda en la solución del tampón</p>
<p>4PX PRESIONAR CAL</p>  <p>La calibración requiere un minuto. <b>ESPERAR 60 S</b></p> <p>⑩</p>	<p>4PX CALIDAD 100%</p> <p>Calidad de la sonda</p> <p>⑪</p>	 <p>⑫</p> <p>Lavar la sonda</p>
 <p>⑬</p>	 <p>Presionar la tecla Key para salir y guardar los datos</p> <p>⑭</p>	<p>Estado normal de medida y control</p> <p>⑮</p>

**Nota:**

Si se programa la función Calibración = 7 pH, el sistema realizará la calibración sólo para el punto 7 pH

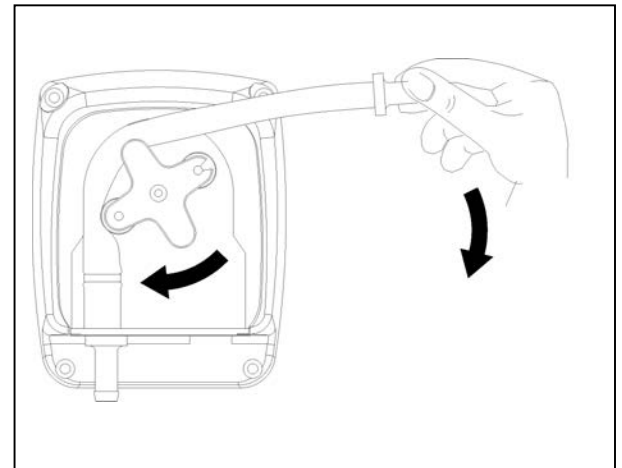
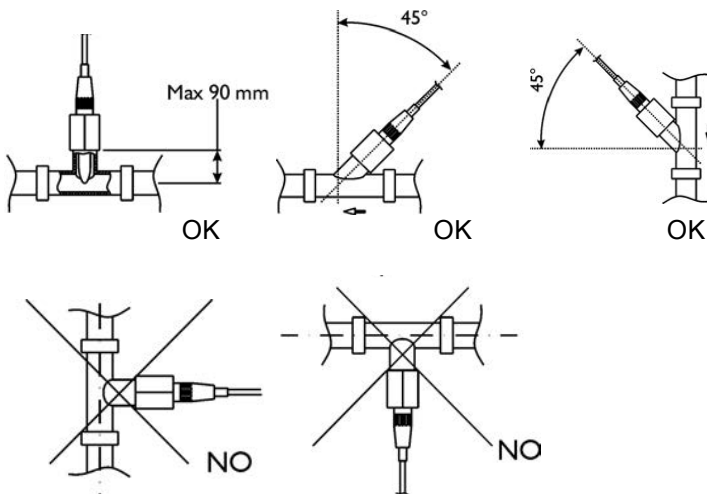
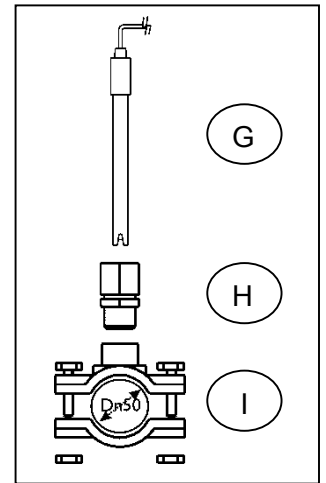
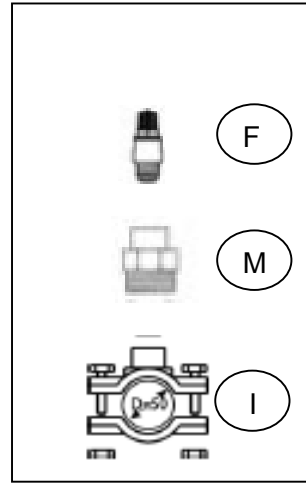
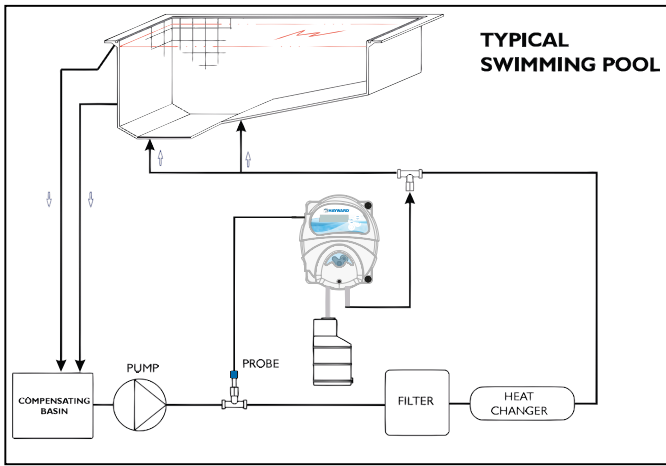

Alarma	Pantalla	Relé	Acciones
Nivel	NIVEL 7.2 PH	Alarma relé cerrado	- Presionar la tecla Intro para desactivar la alarma a distancia - Restablecer el nivel de producto en el contenedor
OFA Primera Alarma (Tiempo >70%)	ALARMA OFA 7.2 PH	Alarma relé abierto	- Presionar la tecla Intro para desactivar la alarma
OFA Segunda Alarma (Tiempo=100%)	STOP OFA 7.2 PH	Alarma relé cerrado	- Presionar la tecla Intro para desactivar la alarma
Caudal agua (bomba de recirculación apagada)	CAUDAL 7.2 PH	Alarma relé abierto	- Reactivar la bomba de recirculación del agua.
Error de sistema	ERROR PAR[METRO	Alarma relé abierto	- Presionar Intro para restablecer los parámetros predeterminados - Daño al sistema
Función de calibración	ERROR 7 PH ERROR 4 PH	Alarma relé abierto	- Sustituir la sonda o la solución tampón y repetir la calibración

**Parámetros de fábrica:**

- Idioma = **Fr (Francés)**
- Valor de Puesta a punto = **Ácido**
- Método de dosificación = **Ácido**
- Tiempo OFA (alarma de sobrecarga) = **OFF**
- Calibración = **7/4 (2 puntos)**
- Entrada Flujo = **ON**

**Para restablecer los parámetros predeterminados (Default), realizador lo siguiente:**

- Parar el sistema Basic
- Activar el sistema Basic manteniendo presionadas las teclas flecha HACIA ARRIBA (UP) y HACIA ABAJO (DOWN).
- El sistema indicará **INIT.DEFAULT NO**
- Presionar la flecha HACIA ARRIBA (UP) **INIT.DEFAULT YES**
- Presionar la tecla Enter para restablecer los parámetros.



# Regulateur de PH – EZ PH

## Contenu de l'emballage

- A) Régulateur "EZ PH"
- B) Tube d'aspiration PVC Cristal Ø 4x6 (4 m)
- C) Tube de refoulement PE Ø 4x6 (5 m)
- D) Kit étrier de fixation
- E) Lest d'aspiration (PVC)
- F) Clapet d'injection (3/8" GAS)
- G) Electrode pH SPH-1
- H) Porte sonde PSS3 (1/2" GAS)
- I) Collier de prise en charge pour porte sonde et clapet d'injection (φ=50 mm)
- L) Kit solution tampon pH 4, pH 7, H<sub>2</sub>O
- M) Réduction pour clapet d'injection

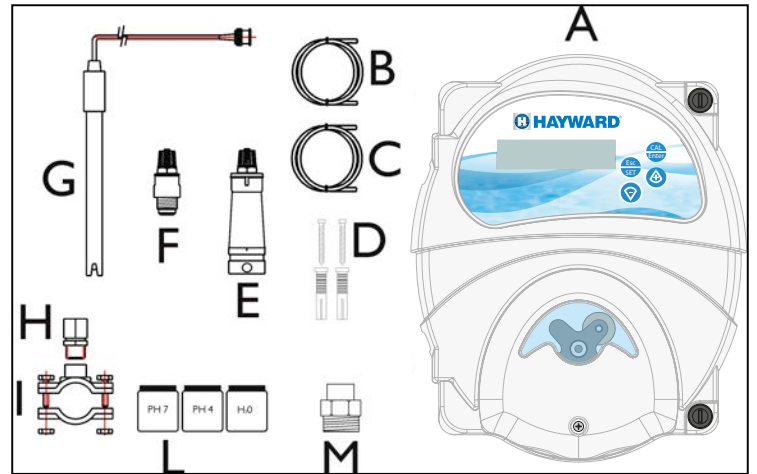

## SPÉCIFICATIONS TECHNIQUES

Dimensions (H – L – P)	234x162x108 mm
Poids	1 kg
Alimentation	230 VC.A.
Consommation	12 W ou 18 W
Débit de la pompe	1,5 l/h
Contre-pression maximale	1,5 bar
État de la pompe	Pause - Activation
Échelle de mesure	0 ÷ 14,0 pH 0 ÷ +1000 mV
Précision de la mesure	± 0,1 pH; ±10 mV
Mesure d'exactitude	± 0,02 pH; ±2 mV
Étalonnage de l'électrode	Automatique

## Fixation murale

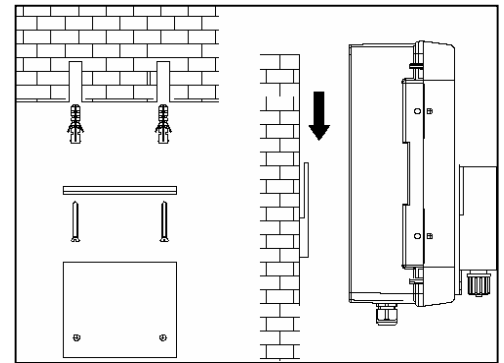

## ATTENZIONE / WARNING / ATTENTION / ACHTUNG

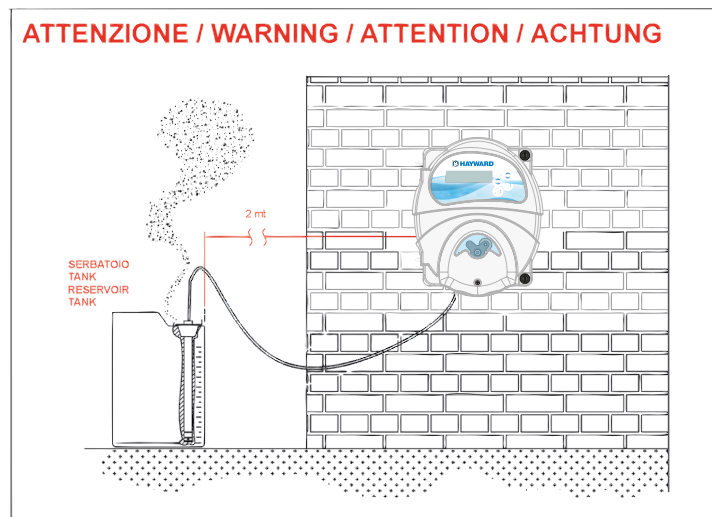

Reglage de la Langue

Tm25°C 6,5pH



Setup

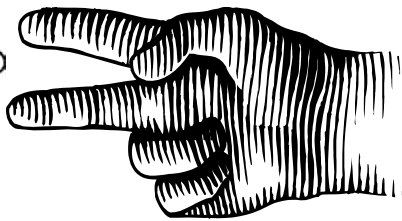

Paramètre configuration



Config pompe  
Mode pH



Entrer / Valider



Modifier

mettre mode pH



debit  
off



Entrer / Valider



Modifier

changer en on



langue  
français



Entrer / Valider



Modifier

changer langue

## Présentation menu simplifié - QUICK START page 2

### Reglage point de consigne pH

Tm25°C 6,5pH



appui maintenu

Sp 7.0 pH  
Tm2 5.0pH

Valeur de pH clignote



pour réglage

Sp 7.0 pH  
Tm2 5.0pH

Réglage de 1 à 14

### Amorçage pompe doseuse



appui prolongé

### Sortir du programme



Exit  
Sauvegarder

Clignote



Modifier



Valider

Calibrage de la sonde



appui prolongé

Tm25°C 6,5pH

Calibrage pompe

Relachement de la touche



B.Sol 7 pH  
Press CAL

Clignote

Wait 60s  
B.Sol 7pH



Clignote

Attendre décompte 60s

Qualite 100%  
Sol tamp 7pH

Terminer avec la page 9

## PRESENTATION COMPLETE - REGLAGE DES PARAMETRES

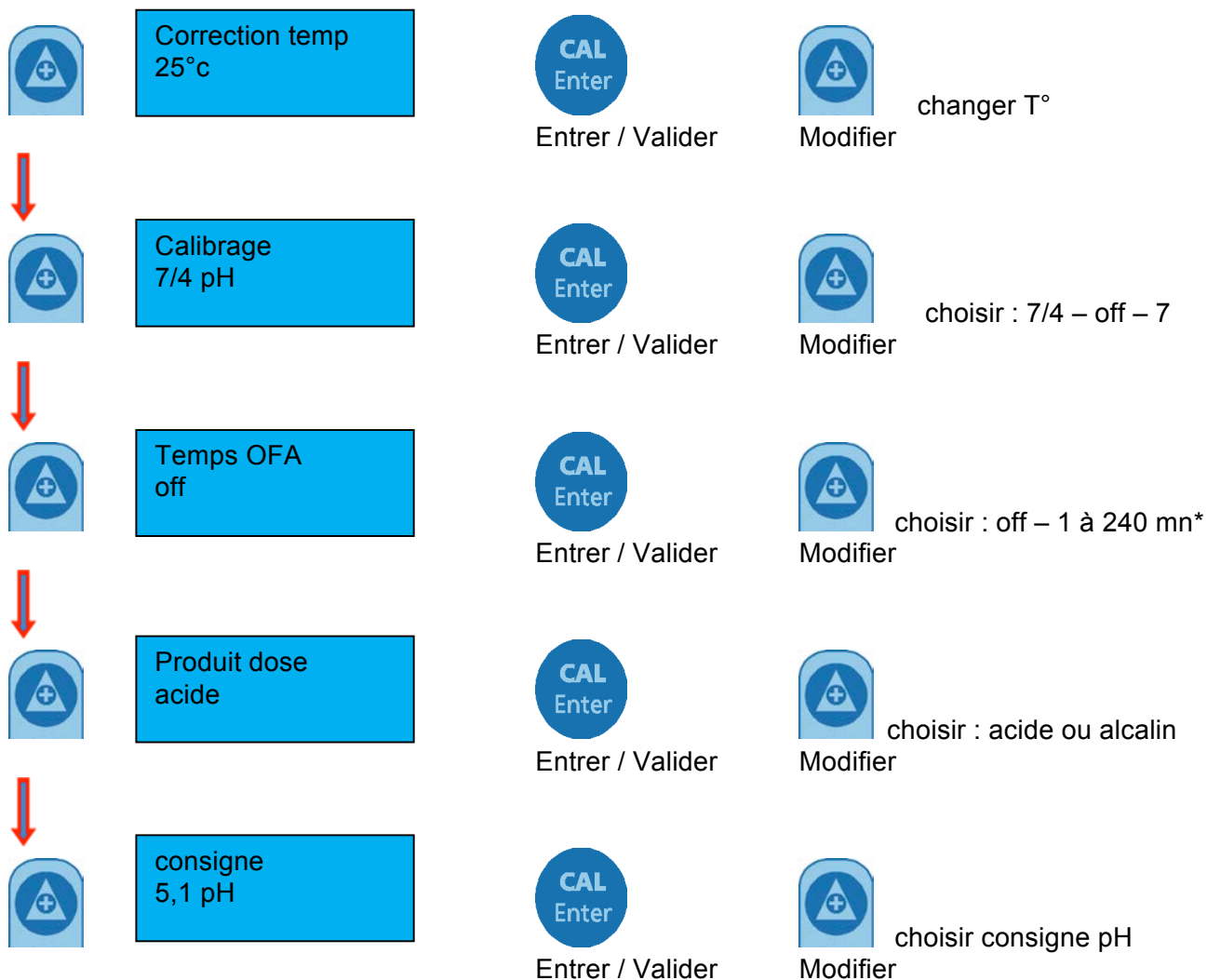

- OFA = Over Feed Alarme = Alarme utilisée pour arrêter l'injection de pH quand le point de mesure reste inchangé pendant x mn

# PRESENTATION COMPLETE - REGLAGE DES PARAMETRES



Setup

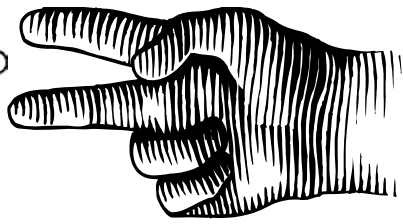

Paramètre configuration



Config pompe  
Mode pH



Entrer / Valider



Modifier

mettre mode pH



debit  
off



Entrer / Valider



Modifier

changer en on



langue  
français



Entrer / Valider



Modifier

changer langue

# PRESENTATION COMPLETE - REGLAGE DES PARAMETRES

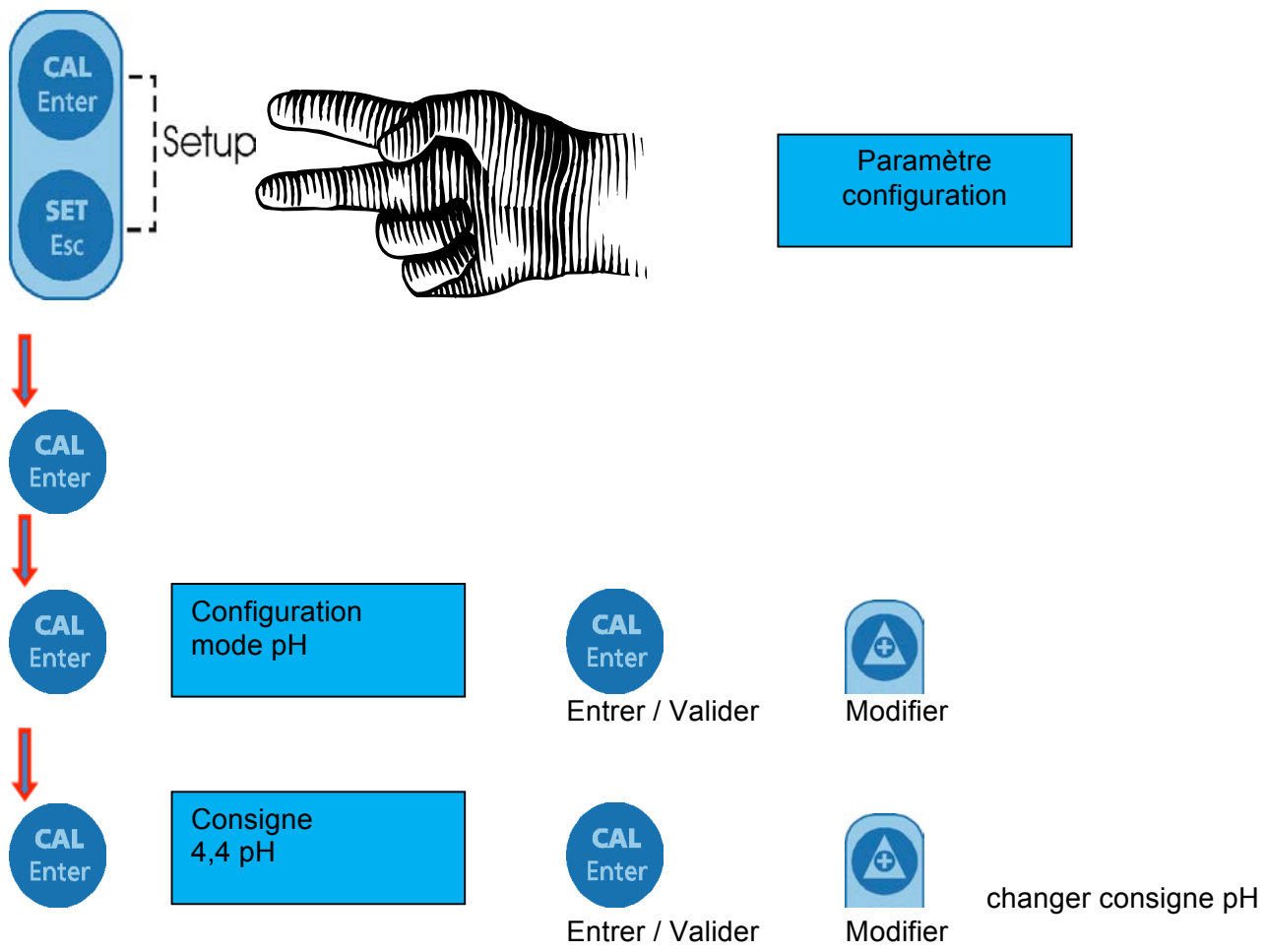





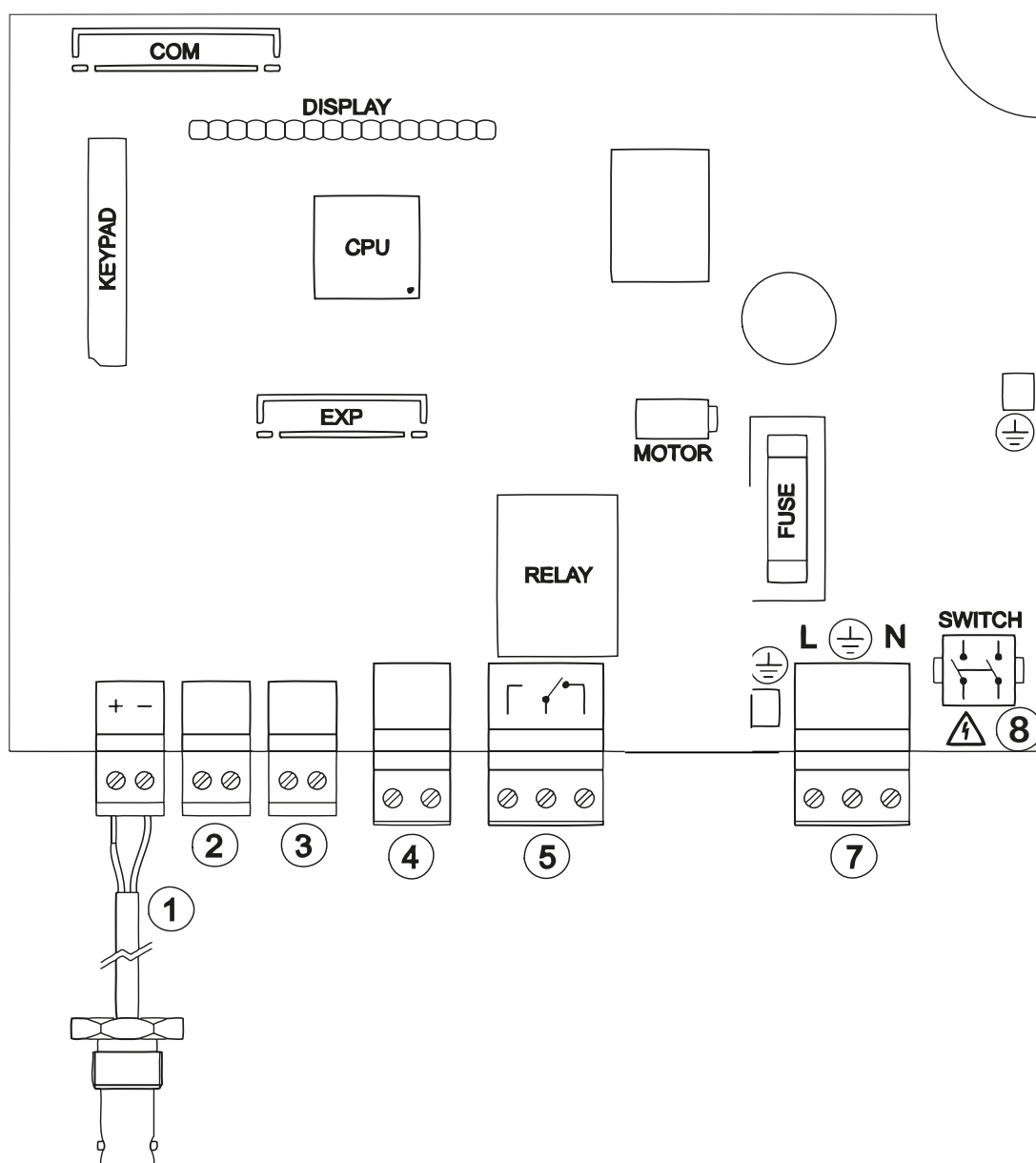





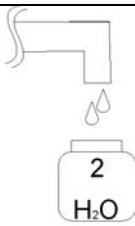

## RACCORDEMENTS

- 1) Entrée sonde pH
- 2) Entrée Sonde Température (PT100 non fournie)
- 3) Entrée sonde de niveau (Produit dans le Bidon)
- 4) Entrée Flow, débit pompe de recirculation (signal électrique 230 V ~.)
- 5) Sortie Relais Alarme à distance (Contact libre, Relais 250 V ~ 10 A résistif)
- 7) Alimentation 230 V~ 50 Hz.
- 8) Interrupteur d'alimentation (situé en haut à droite du coffret )

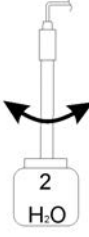

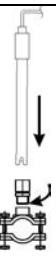

## CALIBRAGE SONDE pH

 <p>①</p>	 <p>②</p>	 <p>③</p> <p>Laver la sonde</p>
 <p>④</p> <p>Maintenir la sonde dans la solution tampon</p>	<p><b>CALIBRAGE</b></p>  <p>Appuyer sur la touche CAL pendant 3 secondes):</p> <p>⑤</p>	<p><b>7PH PRESSER CAL</b></p>  <p>Le calibrage dure une minute. <b>PATIENTER 60S</b></p> <p>⑥</p>
<p><b>7PH QUALIT 100%</b></p> <p>Qualité de la sonde</p> <p>⑦</p>	 <p>⑧</p> <p>Laver la sonde</p>	 <p>⑨</p> <p>Maintenir la sonde dans la solution tampon</p>
<p><b>4PH PRESSER CAL</b></p>  <p>Le calibrage dure une minute. <b>PATIENTER 60S</b></p> <p>⑩</p>	<p><b>4PH QUALITE 100%</b></p> <p>Qualité de la sonde</p> <p>⑪</p>	 <p>⑫</p> <p>Laver la sonde</p>
 <p>⑬</p>	 <p>Appuyer sur la touche Key pour quitter et enregistrer les données</p> <p>⑭</p>	<p>État Normal de mesure et contrôle</p> <p>⑮</p>

**Remarque:**

Si l'on programme la fonction Calibrage = 7 pH, le système n'effectue le calibrage que pour le point 7 pH.

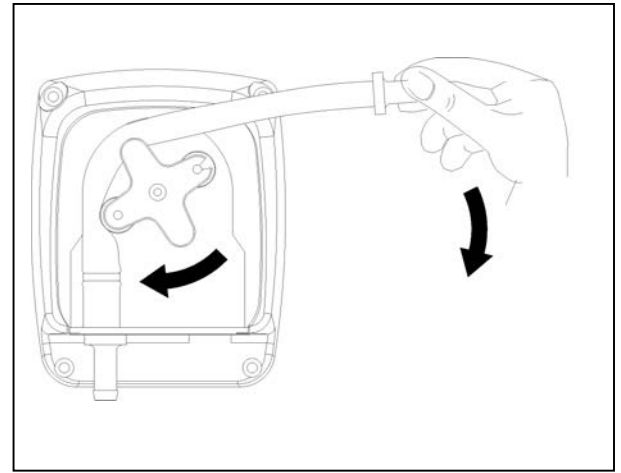
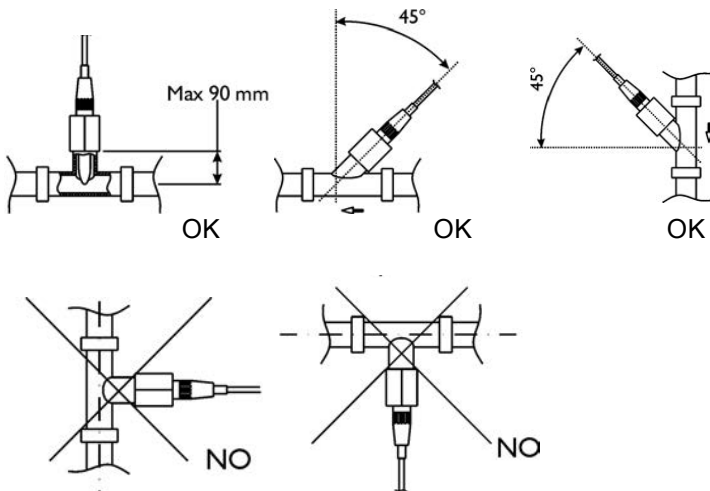
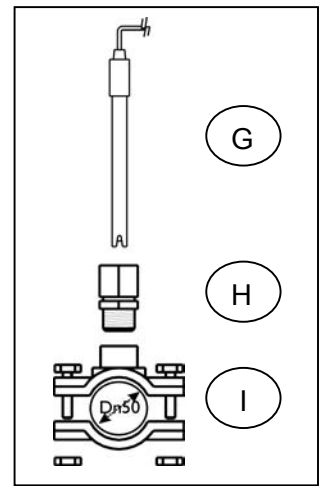
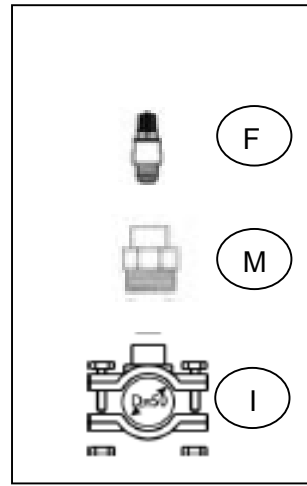
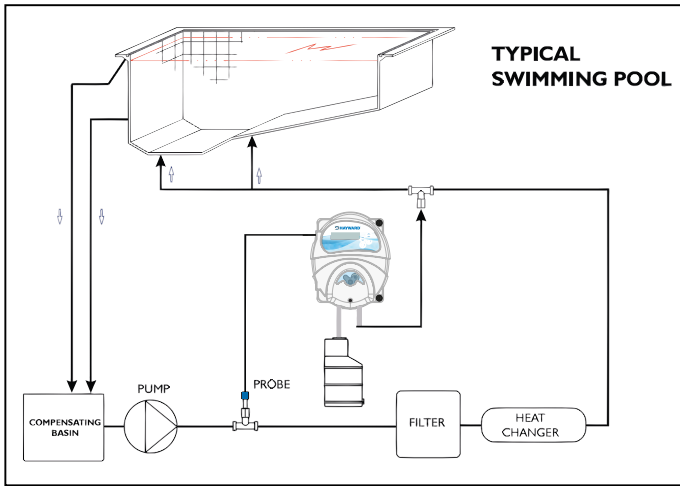

Alarme	Écran	Relais	Actions à exécuter
Niveau	NIVEAU 7,2 PH	Alarme relais fermé	- Appuyer sur la touche Enter pour désactiver l'alarme à distance - Rétablir le niveau de produit dans le bidon
OFA Première Alarme (Temps >70%)	ALARME OFA 7,2 PH	Alarme relais ouvert	- Appuyer sur la touche Enter pour désactiver l'alarme
OFA Deuxième Alarme (Temps=100%)	STOP OFA 7,2 PH	Alarme relais fermé	- Appuyer sur la touche Enter pour désactiver l'alarme
Débit eau (pompe de recirculation éteinte)	DEBIT 7,2 PH	Alarme relais ouvert	- Réactiver la pompe de circulation eau.
Erreur de système	PARAMETER ERROR	Alarme relais ouvert	- Appuyer sur Enter pour restaurer les paramètres par défaut - Système endommagé
Fonction d'étalonnage	ERREUR 7 PH ERREUR 4 PH	Alarme relais ouvert	- Remplacer la Sonde ou la Solution tampon et répéter le calibrage.

**Paramètres d'usine :**

- Langue = **FR (Français)**
- Set Point valeur = **7,4 pH**
- Méthode de dosage = **Acide**
- Temps OFA (alarme de surcharge) = **OFF**
- Calibrage = **7/4 (2 points)**
- Entrée Flux = **ON**

**Pour restaurer les paramètres par défaut (Défaut), agir de la façon suivante:**

- Arrêter le système Basic
- Activer le système Basic en maintenant les touches flèche HAUT (UP) et flèche BAS (DOWN) appuyées.
- Le Système affiche **INIT.DEFAULT NO**
- Appuyer sur flèche HAUT (UP)  
**INIT.DEFAULT YES**
- Appuyer sur la touche Enter pour restaurer les paramètres.

# Regolatore di PH - EZ PH

## Contenuto della confezione

- A) Regolatore "EZ PH"
- B) Tubo d'aspirazione PVC Cristal Ø 4x6 (4 m)
- C) Tubo di mandata PE Ø 4x6 (5 m)
- D) Kit staffa di fissaggio
- E) Filtro di fondo (PVC)
- F) Valvola d'iniezione (3/8" GAS)
- G) Elettrodo pH SPH-1
- H) Porta sonda PSS3 (1/2" GAS)
- I) Collare di presa per fissaggio porta sonda e valvola d'iniezione (φ=50 mm)
- L) Kit di soluzione tampone pH 4, pH 7, H<sub>2</sub>O
- M) Riduttore per valvola d'iniezione

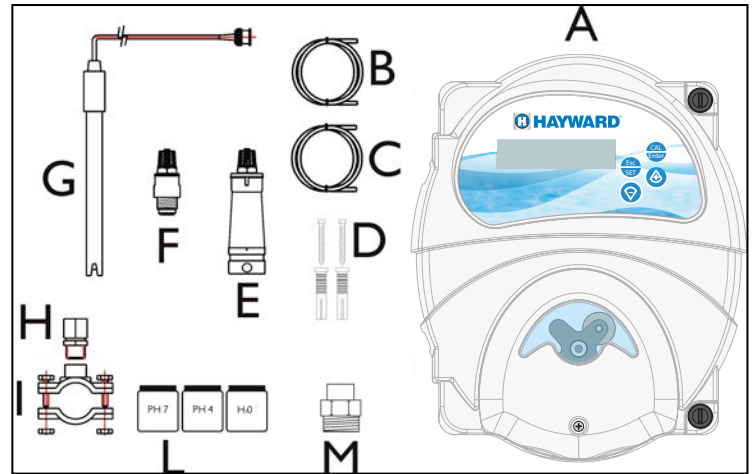

## SPECIFICHE TECNICHE

Dimensioni (A – L – P)	234x162x108 mm
Peso	1 kg
Alimentazione	230 VC.A
Potenza	12 W o 18 W
Uscita della pompa	1,5 l/h
Contro pressione massima	1,5 bar
Stato della pompa	Pausa - Accensione
Scala di misura	0 ÷ 14,0 pH 0 ÷ +1000 mV
Precisione di misura	± 0,1 pH; ±10 mV
Accuratezza della misura	± 0,02 pH; ±2 mV
Calibrazione elettrodo	Automatica

## Installazione a parete

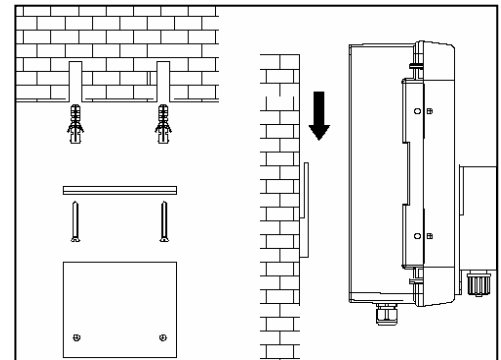

## ATTENZIONE / WARNING / ATTENTION / ACHTUNG

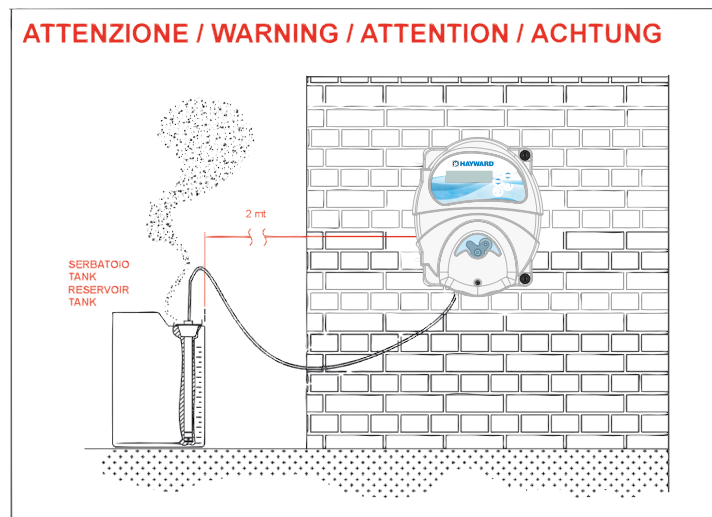

Selezione della lingua

Tm25°C 6,5pH



Setup

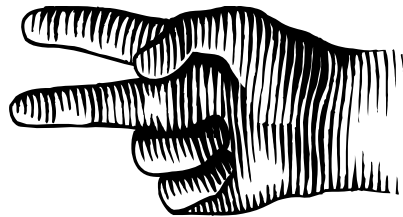

Parametri di configurazione



Config pompa  
Modalità pH



Inserisci/Conferma



Modifica

inserire modo pH



portata  
off



Inserisci/Conferma



Modifica

cambiare in on



lingua  
francese



Inserisci/Conferma



Modifica

cambiare lingua

## Presentazione del menù semplificato - QUICK START pagina 2

### Regolazione del setpoint del pH

Tm25°C 6,5pH



tenere premuto

Sp 7.0 pH  
Tm2 5.0pH

Il valore pH lampeggia



per la regolazione

Sp 7.0 pH  
Tm2 5.0pH

Regolazione da 1 a 14

### Adescamento pompa dosatrice



premere a lungo

### Uscire dal programma



Exit  
Salva

Lampeggia



Modifica



Conferma

Presentazione del menù semplificato - QUICK START pagina 3

Calibrazione della sonda



premere a lungo

Tm25°C 6,5pH

Calibrazione  
pompa

Rilascio del tasto



B.Sol 7 pH  
Press CAL

Lampeggia

Wait 60s  
B.Sol 7pH



Lampeggia

Attendere conteggio 60s

Qualità 100%  
Sol tamp 7pH

Terminare alla pagina 9

## PRESENTAZIONE COMPLETA - CONFIGURAZIONE DEI PARAMETRI

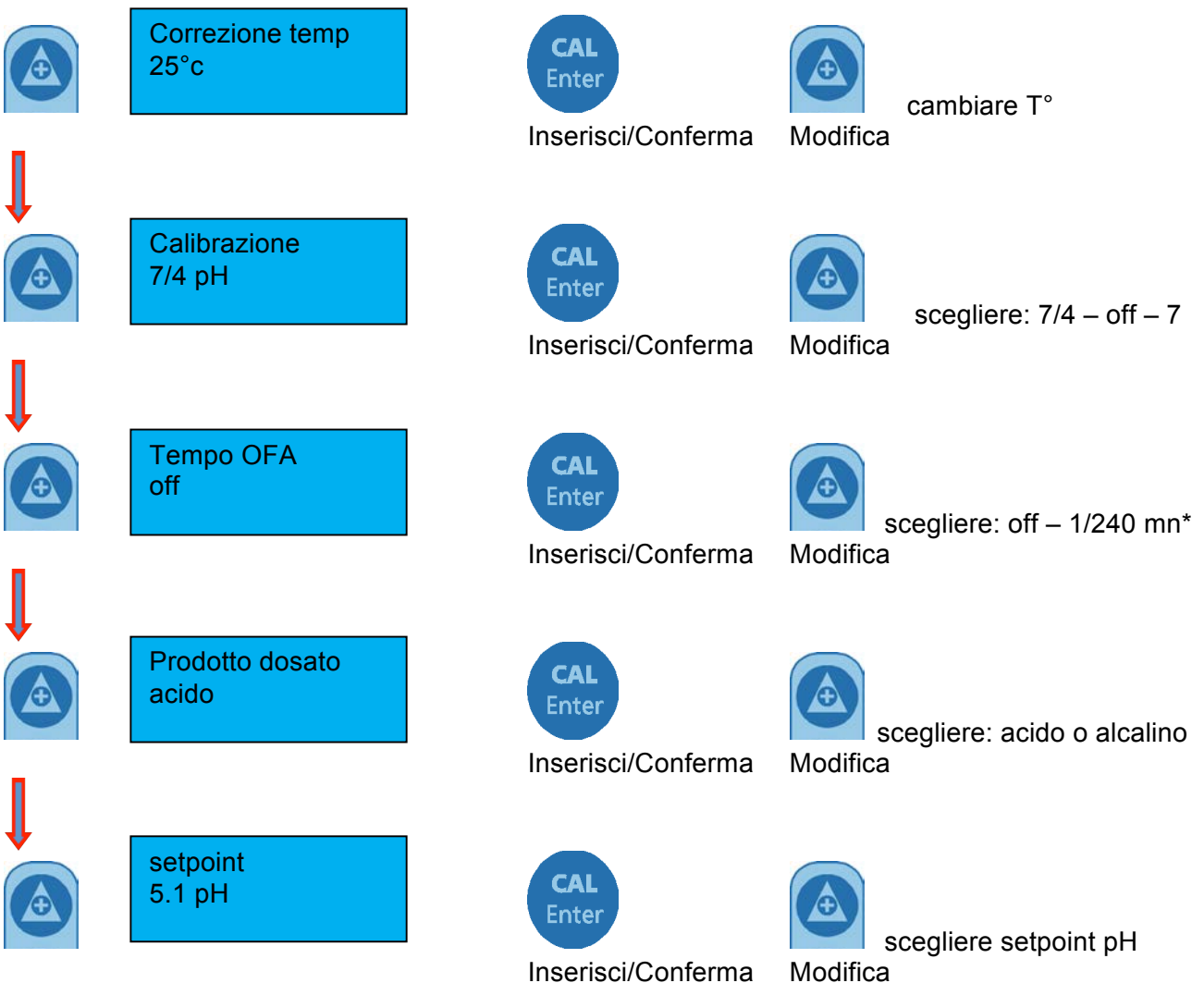
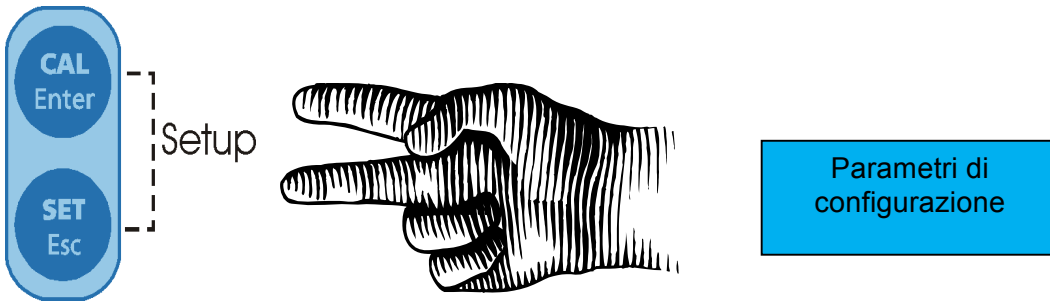

- OFA = Over Feed Alarm = Allarme impiegato per arrestare l'iniezione di pH se il setpoint resta immutato per x min

## PRESENTAZIONE COMPLETA - CONFIGURAZIONE DEI PARAMETRI

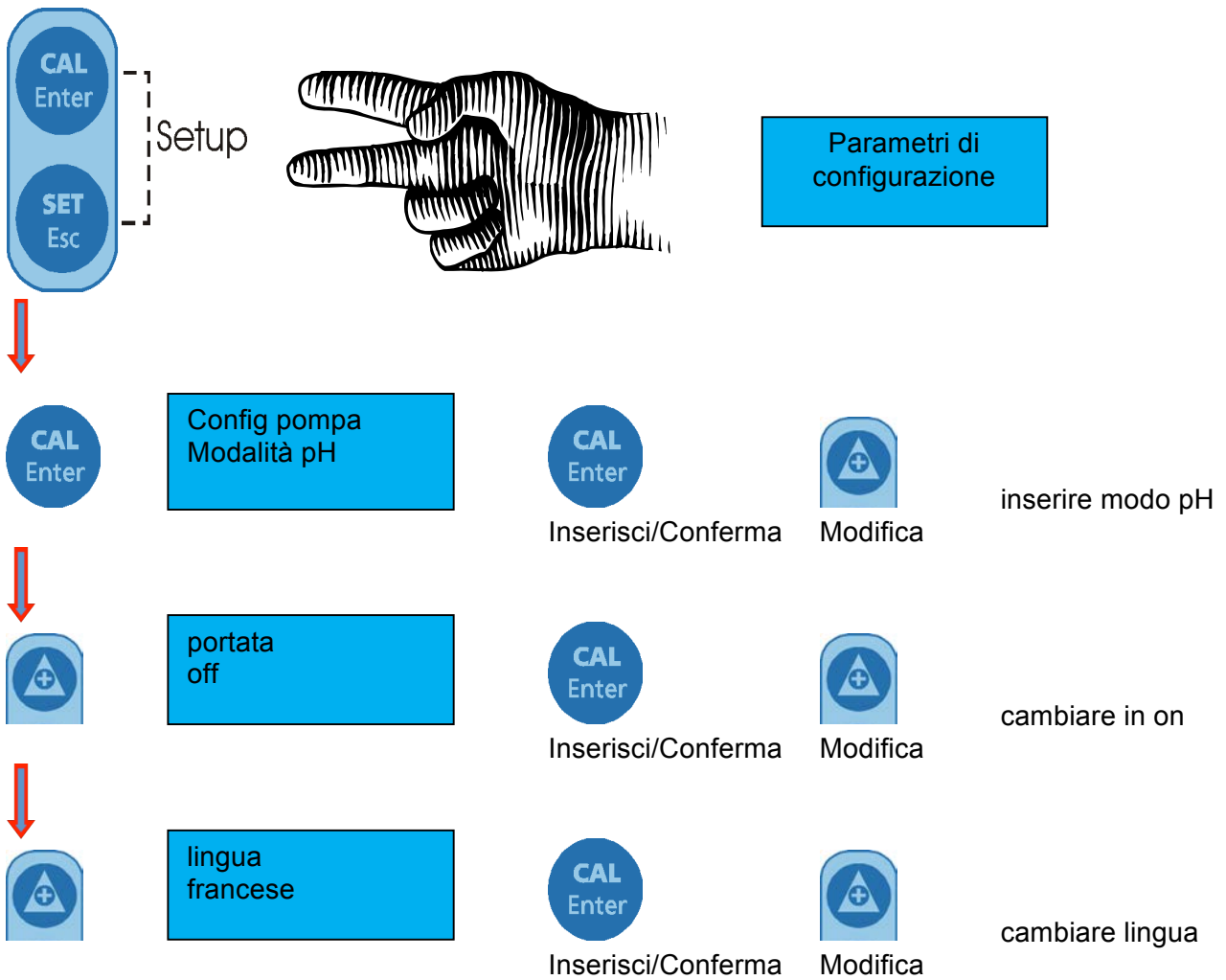



# PRESENTAZIONE COMPLETA - CONFIGURAZIONE DEI PARAMETRI

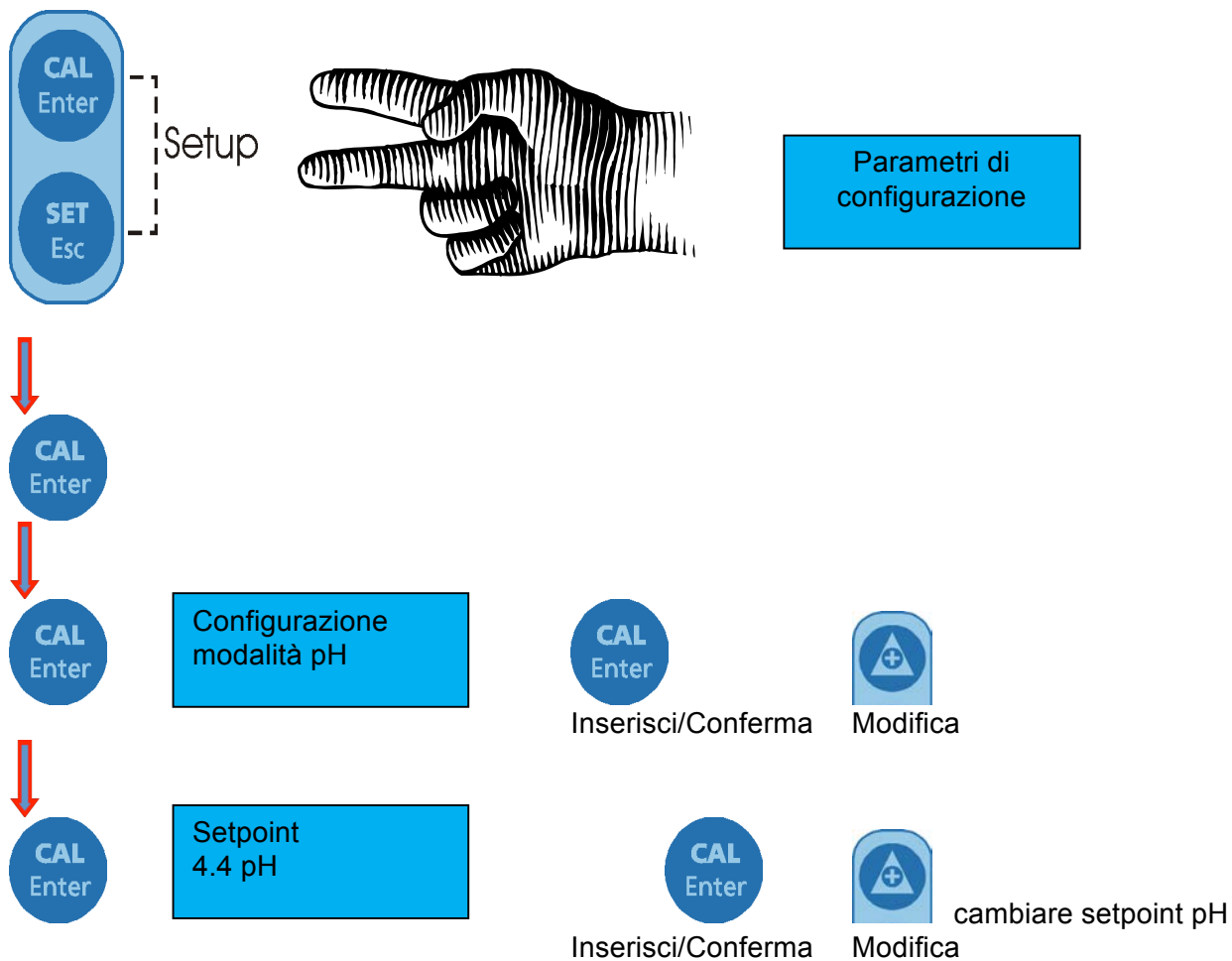





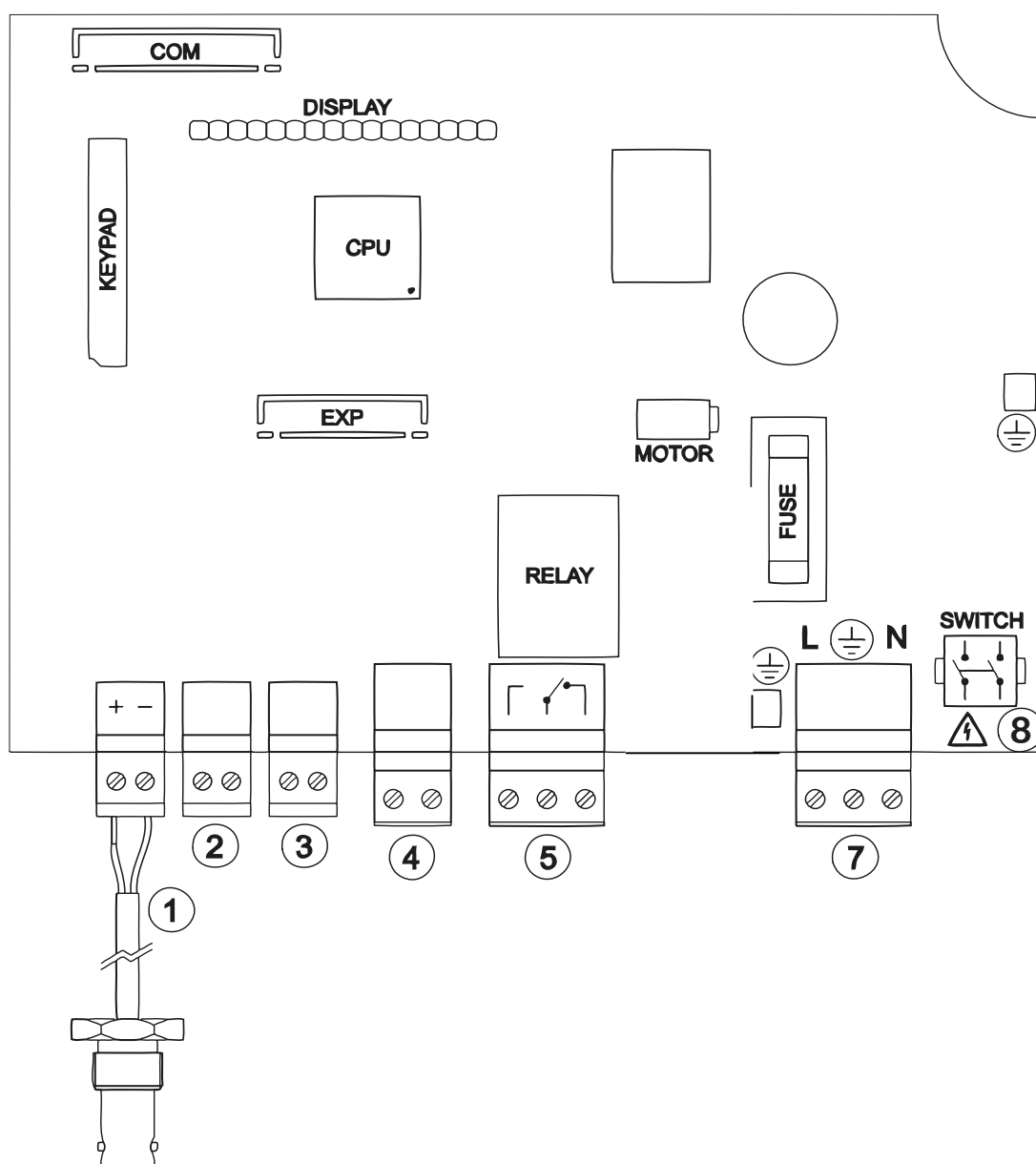



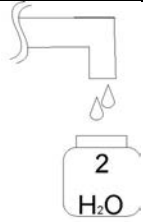

## COLLEGAMENTI

- 1) Ingresso sonda pH
- 2) Ingresso sonda temperatura (PT100 non fornita)
- 3) Ingresso sonda di livello (Prodotto nel contenitore)
- 4) Ingresso Flow, portata pompa di ricircolo (segnale elettrico 230 V ~.)
- 5) Uscita relè allarme a distanza (contatto libero, relè 250 V ~ 10 A resistivo)
- 7) Alimentazione 230 V~ 50 Hz.
- 8) Interruttore di alimentazione (posto in alto a destra della centralina)

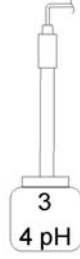

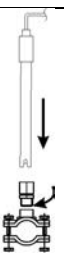
## CALIBRAZIONE SONDA pH

 <p><b>1</b></p>	 <p><b>2</b></p>	 <p><b>3</b> Lavare la sonda</p>
 <p><b>4</b> Conservare la sonda nella soluzione tampone</p>	<p><b>CALIBRAZIONE</b></p>  <p>Premere il tasto CAL per 3 secondi</p> <p><b>5</b></p>	<p><b>7PH PREMERE CAL</b></p>  <p>La calibrazione richiede un minuto. <b>ATTENDERE 60 S</b></p> <p><b>6</b></p>
<p><b>7PH QUALIT 100%</b></p> <p>Qualità della sonda</p> <p><b>7</b></p>	 <p><b>8</b> Lavare la sonda</p>	 <p><b>9</b> Conservare la sonda nella soluzione tampone</p>
<p><b>4PH PREMERE CAL</b></p>  <p>La calibrazione richiede un minuto. <b>ATTENDERE 60 S</b></p> <p><b>10</b></p>	<p><b>4PH QUALIT 100%</b></p> <p>Qualità della sonda</p> <p><b>11</b></p>	 <p><b>12</b> Lavare la sonda</p>
 <p><b>13</b></p>	 <p>Premere il tasto Key per uscire e salvare i dati</p> <p><b>14</b></p>	<p><b>15</b> Stato normale di misura e controllo</p>

**Nota:**

Se si programma la funzione Calibrazione = 7 pH, il sistema effettuerà la calibrazione solo per il punto 7 pH

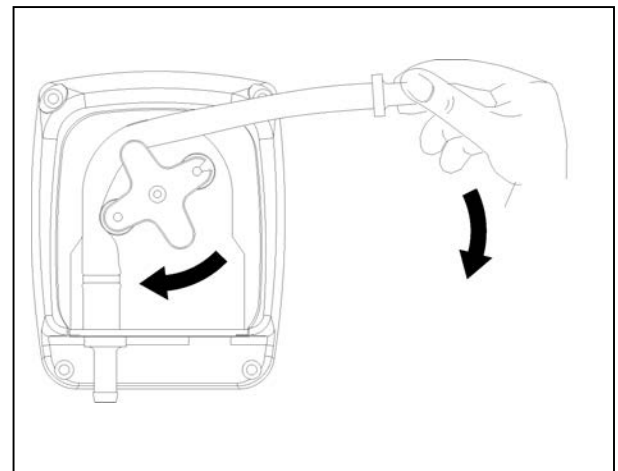
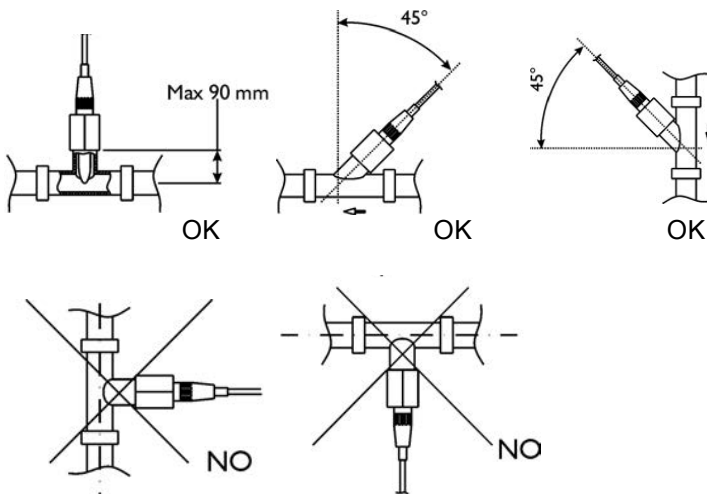
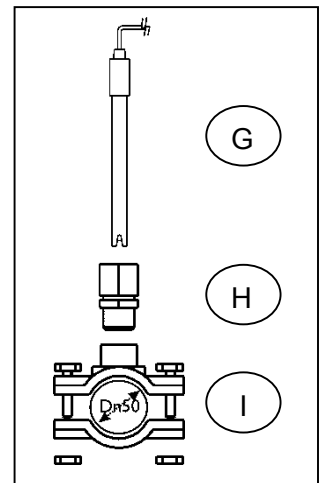
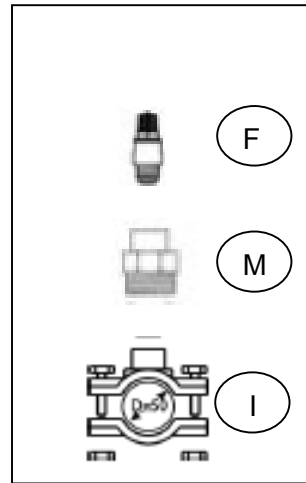
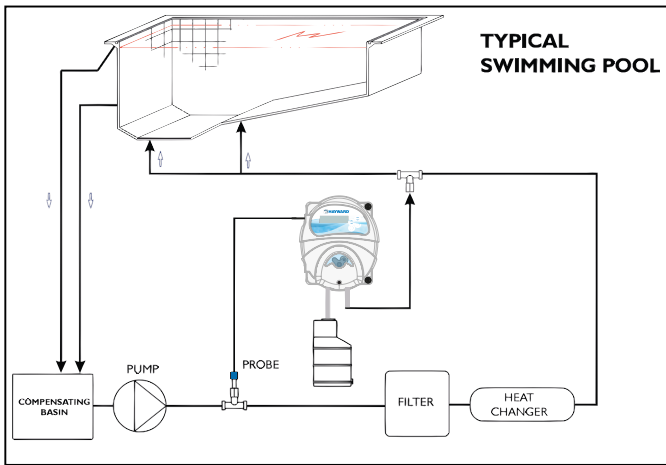

Allarme	Schermo	Relè	Azioni
Livello	LIVELLO 7.2 PH	Allarme relè chiuso	- Premere il tasto Enter per disattivare l'allarme a distanza - Ripristinare il livello di prodotto nel contenitore
OFA Primo Allarme (Tempo >70%)	ALLARME OFA 7.2 PH	Allarme relè aperto	- Premere il tasto Enter per disattivare l'allarme
OFA Secondo Allarme (Tempo=100%)	STOP OFA 7.2 PH	Allarme relè chiuso	- Premere il tasto Enter per disattivare l'allarme
Portata acqua (pompa di ricircolo spenta)	PORTATA 7.2 PH	Allarme relè aperto	- Riattivare la pompa di ricircolo acqua.
Errore di sistema	PARAMETER ERROR	Allarme relè aperto	- Premere Enter per ripristinare i parametri di default - Danno al sistema
Funzione di taratura	ERRORE 7 PH ERRORE 4 PH	Allarme relè aperto	- Sostituire la sonda o la soluzione tampone e ripetere la calibrazione

**Parametri di fabbrica:**

- Lingua = **FR (Francese)**
- Valore di Set Point = **Acido**
- Metodo di dosaggio = **Acido**
- Tempo OFA (allarme di sovraccarico) = **OFF**
- Calibrazione = **7/4 (2 punti)**
- Ingresso Flusso = **ON**

**Per ripristinare i parametri di default (Default), procedere come segue:**

- Arrestare il sistema Basic
- Avviare il sistema Basic tenendo premuti i tasti freccia SU (UP) e GIÙ (DOWN).
- Il sistema indicherà **INIT.DEFAULT NO**
- Premere la freccia SU (UP)  
**INIT.DEFAULT YES**
- Premere il tasto Enter per ripristinare i parametri.