

Flachskimmer für Spiegelbecken

2

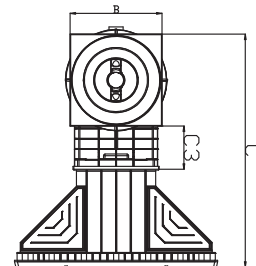

SKIMMER MIROIR	Beschreibung	Ref. Folie	Maß	A	A1	B	C	C3	D2	E1	L	N
		Skimmer Spiegelbecken, große Saugöffnung	3139	mm	483.8	14.5	250.3	634	117.4	142.5	539.1	38
	Skimmer für Spiegelbecken, große Saugöffnung, hellgrau	3139LG										

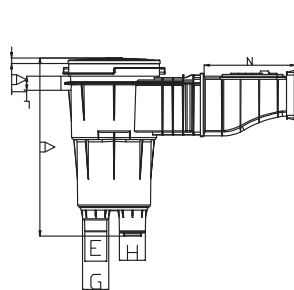
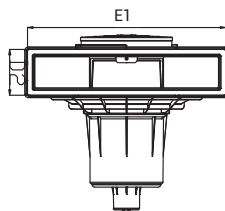
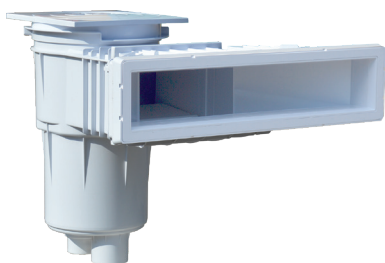
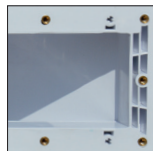

Bei der Installation eines Skimmers für Spiegelbecken wird ein Wasserstandsregler empfohlen. Ref : 3150

Skimmer mit Einsätzen

2

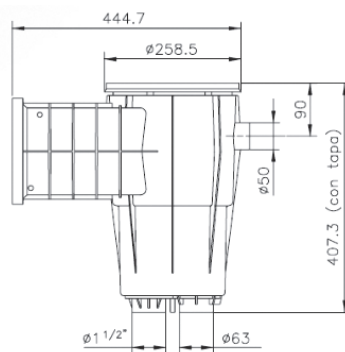

Maß - kleine Saugöffnung

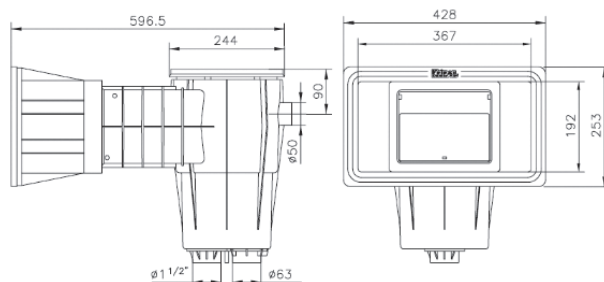

Maß - große Saugöffnung

SKIMMER MIT EINSÄTZEN	Beschreibung	Ref. Folie
		Skimmer folie, kleine Saugöffnung
	Skimmer folie, große Saugöffnung	3129