

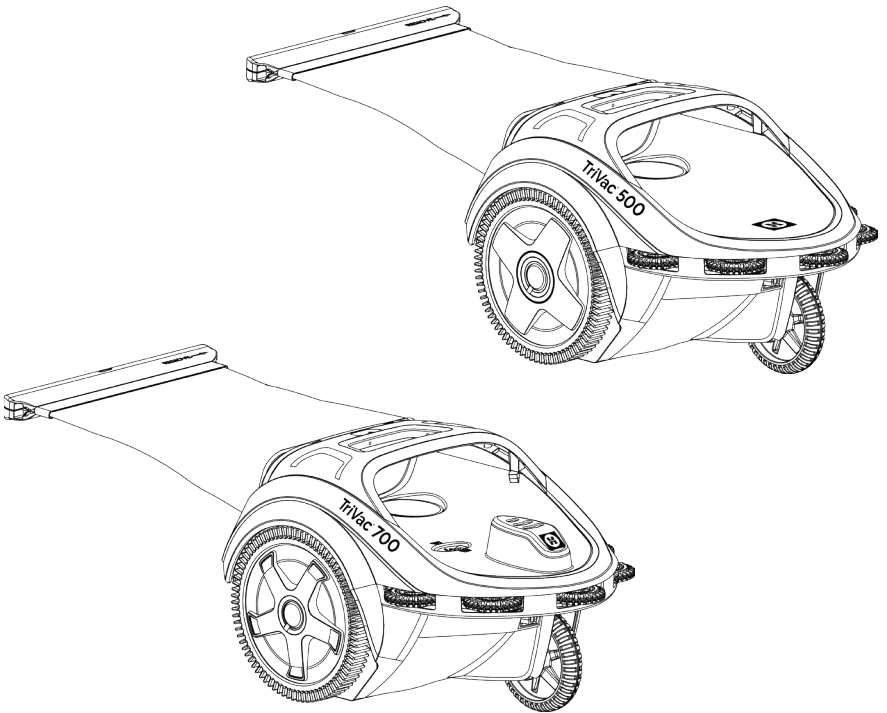

# TriVac™ 500 and 700 Pressure Pool Cleaner Owner's Manual



---

Hayward Pool Products  
620 Division Street  
Elizabeth, NJ 07201  
[www.Hayward-Pool.com](http://www.Hayward-Pool.com)

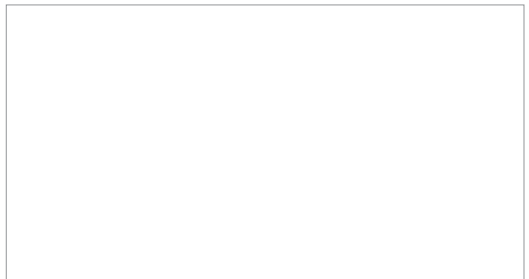

# SAFETY FACTS

---

**DO NOT** use to remove large debris in new pools, such as rocks or concrete.

**REMOVE** the cleaner before chemically shocking your pool

**DO NOT** swim with cleaner 

Store the cleaner in a shaded safe area

Hoses must be stored straight. **DO NOT** coil the hose

Keep away from children and pets

**REMOVE** cleaner when performing backwash

**REMEMBER** safety first

**When temperatures are at or below freezing, it's important to protect the TriVac™ in order to avoid freeze damage.**

## TOOLS

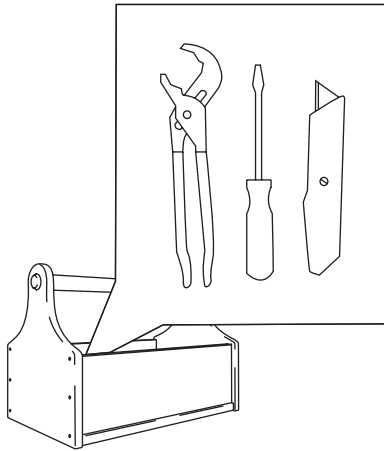

## LEGEND



Tip



Filtration pump



Pool chemicals



Warning



Booster pump

# CARTON CONTENTS

TriVac™ 500 or TriVac™ 700

1x

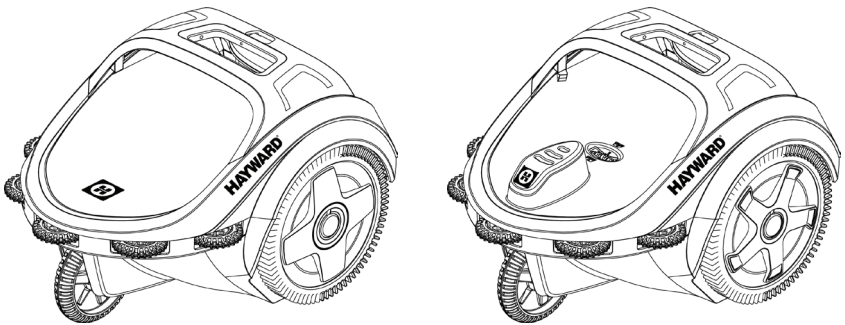

4' Hose  
1x extension

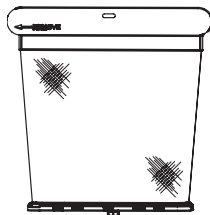

1x

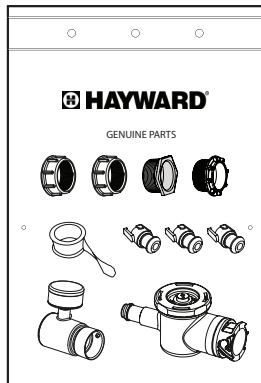

1x

TriVac™ 500 and 700

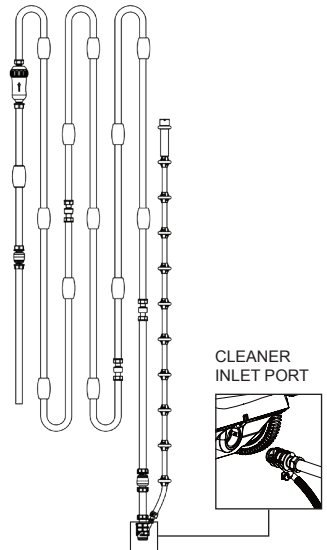

1x Main hose

# PREPARING THE POOL

Manually remove very large and excessive debris from pool (ie. post storm, spring cleaning / pool opening situations).

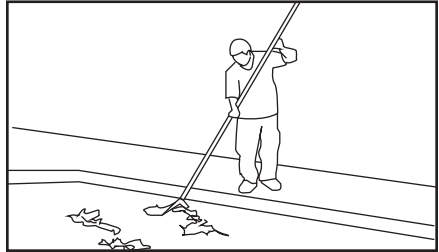

Perform a backwash, clean your filter, skimmer basket and pump basket.

### BACKWASH

The diagram shows a Hayward filter with a central handle. Labels include 'HAYWARD FILTER', 'RINSE', 'BACKWASH', 'CLOSED', and 'BACKWASH' on a side panel.

Illustration of a trash bin with leaves and a brush, representing debris removal.

## POOL CHEMICALS



pH : 7.2 - 7.6  
 Chlorine : 0.5 - 1.5 P.P.M  
 Total Alkalinity : 80 - 150 P.P.M

## DEDICATED RETURN LINE

1-1/2 inch dedicated return line 1-1/2 female thread	+	TriVac™ hexagonal universal wall fitting OR TriVac™ round oversize wall fitting	3/4 inch dedicated return line 3/4 female thread	+	1 1/2 inch NPTF x 3/4 inch NPTM (ADAPTER NOT INCLUDED)	+	TriVac™ hexagonal universal wall fitting OR TriVac™ round oversize wall fitting
		OR					

# CONNECTING THE TriVac™

## INSTALLING WALL FITTING

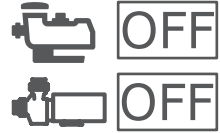
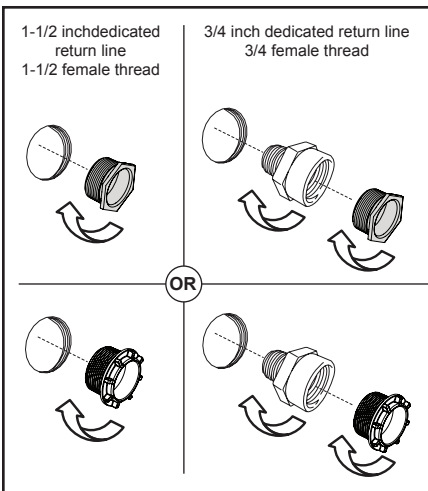
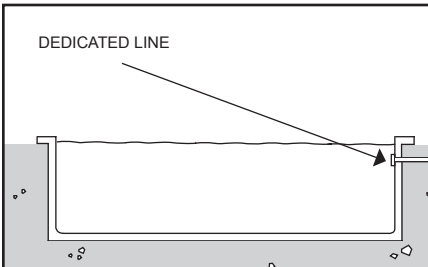
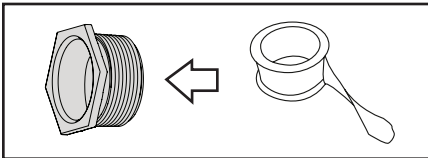
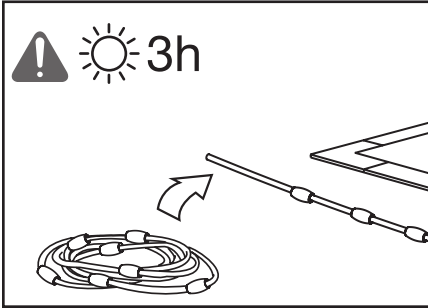

Lay the hose straight for 3 hours  
OR run on bottom mode for a full  
cleaning cycle.



When installing or  
reinstalling the TriVac™  
wall fitting use Teflon tape  
on its plastic threads.

Remove any plug or existing wall  
fitting from dedicated pressure line  
(if any).

Screw the TriVac™ wall fitting into the  
dedicated line.

If the hexagonal wall fitting screws  
all the way into the dedicated line,  
it maybe necessary to replace it with the  
round oversized wall fitting to provide  
better seal.

# SIZING PRESSURE HOSE

Connect hose to cleaner head.

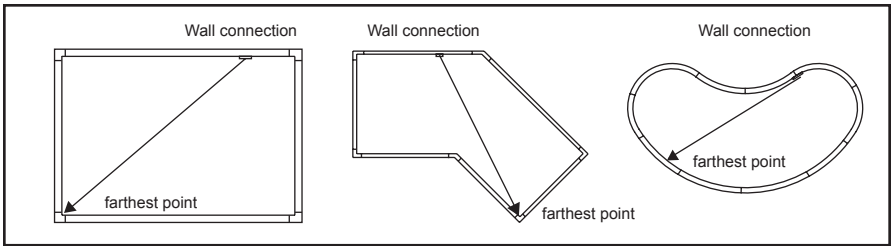
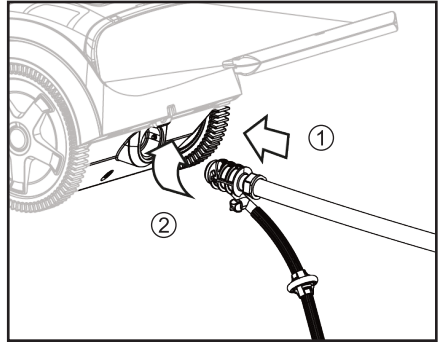

Place cleaner 5ft - 6ft (1.5m) beyond farthest point of pool.

Extend hose back to the location of wall connection.

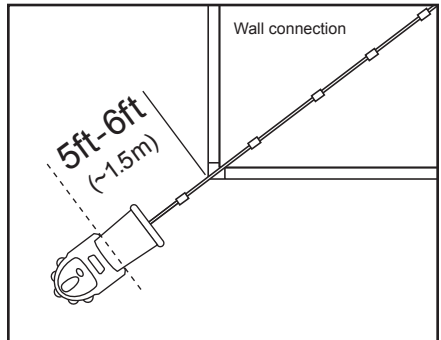

IF

- Hose is too LONG (**3ft or less**), proceed to **page 7**
- Hose is too LONG (**more than 3ft**), proceed to **page 8**
- Hose is too SHORT, proceed to **page 9**

# SIZING PRESSURE HOSE

## IF HOSE IS TOO LONG (3FT (1M) OR LESS OVER THE DECK)

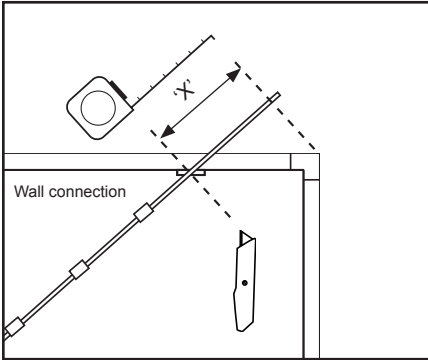

If the hose is too long and reaches beyond the wall connection, cut hose at location of the wall connection.

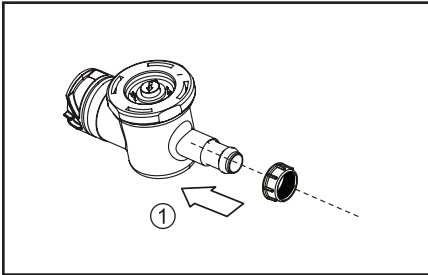
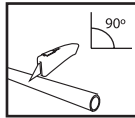

Connect wall connector to hose using mender nut.

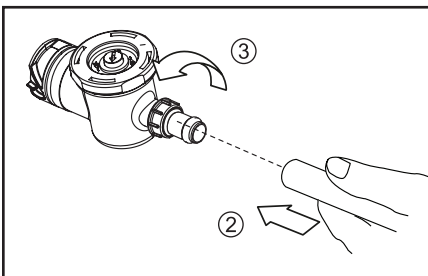

# SIZING PRESSURE HOSE

## IF HOSE IS TOO LONG (MORE THAN 3FT (1M))

1. Measure amount of excess hose.
2. Disconnect filter assembly from hose
3. Measure amount to be removed on last 8ft (2.5m) section, mark hose. (remove in 2ft (0.6m) increments to maintain a good balance of hose excess).
4. Cut hose at the mark. For every 2ft (0.6m) of hose removed one, float should also be removed.
5. Reconnect filter assembly.

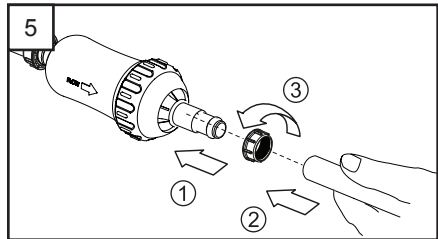
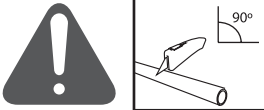
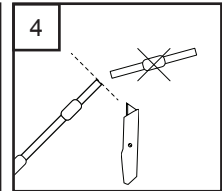
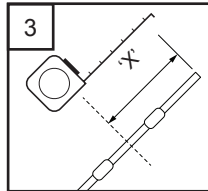
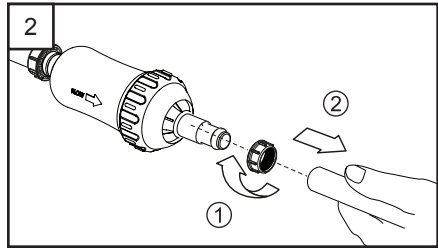
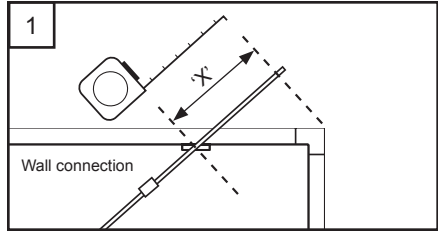

**Connect wall connector using mender nut.**

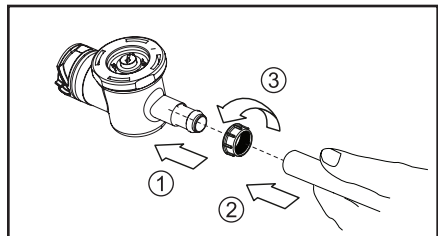



# SIZING PRESSURE HOSE

## IF HOSE IS TOO SHORT



\* An extra 4ft (1.2m) section of hose extension, complete with swivel and floats, is included in packaging.

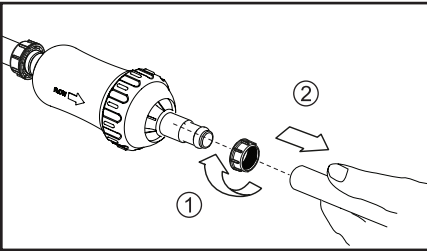

**Disconnect** main hose at filter assembly.

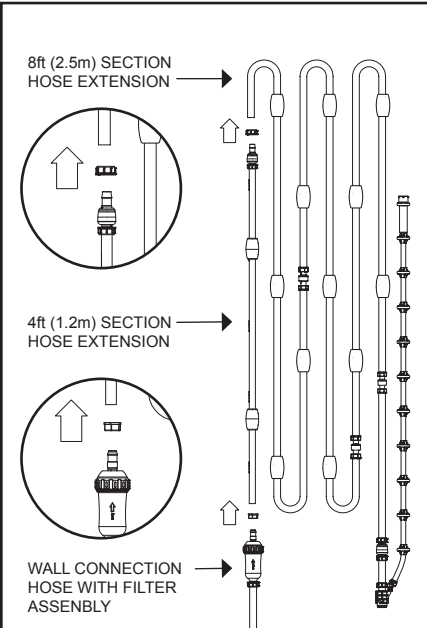

**Connect** 4ft (1.2m) hose extension in between 8ft (2.5m) hose and filter assembly.

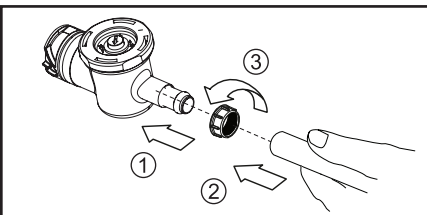

**Connect** opposite end of hose to wall connector using mender nut.

# SETTING PRESSURE



Too much pressure will cause poor cleaning and premature wear of cleaner parts. Low pressure will affect cleaner performance and cleaning capability.



## BACKWASH

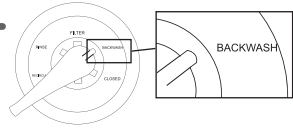

23 PSI (+/- 3)

⚠ Submerge pressure tester

Use a flat blade screwdriver to adjust the wall quick connect red knob to reach 23 PSI (+/- 3)



If using a variable speed pump, always ensure pump speed setting is the same every time cleaner is in use to maintain 23 PSI setting.



Check pressure regularly

# TriVac™ NORMAL OPERATION

The TriVac™ 500 (bottom/wall only) and 700 (when in bottom/wall mode) offer best in class pool coverage. The unique AquaDrive system enables the cleaner to easily climb walls often reaching into areas such as sun shelves or benches that other pressure cleaners simply can't.

While most of the pool can be cleaned in 1 hour, 3 hours is considered normal for complete coverage of a standard pool. The cleaning cycle should be extended on pools with special features or shapes such as shelves, steps or swim-outs to allow the TriVac™ to fully clean all surfaces.

Please note that TriVac™ will not operate properly on areas where the water is less than 8in (20cm) deep. Performance and pool coverage may be affected in cold water conditions (below 55°F/12.8°C), refer to pages 16 & 17 for cold water operating instructions.

## OPERATING THE TriVac™ 700

### CHANGING BOTTOM TO SKIM

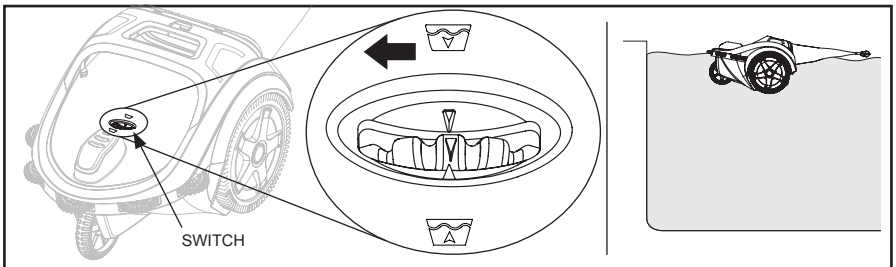

### CHANGING SKIM TO BOTTOM

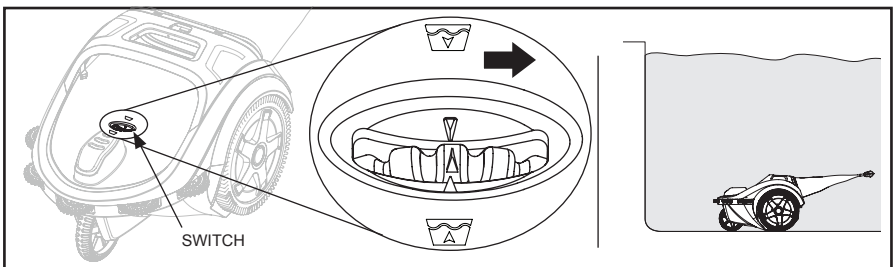

# ADJUSTING THE SWEEP HOSE

## ADJUSTING SWEEP HOSE POWER



Recommend setting is one full turn open. Sweep tail should move in a slow undulating motion.

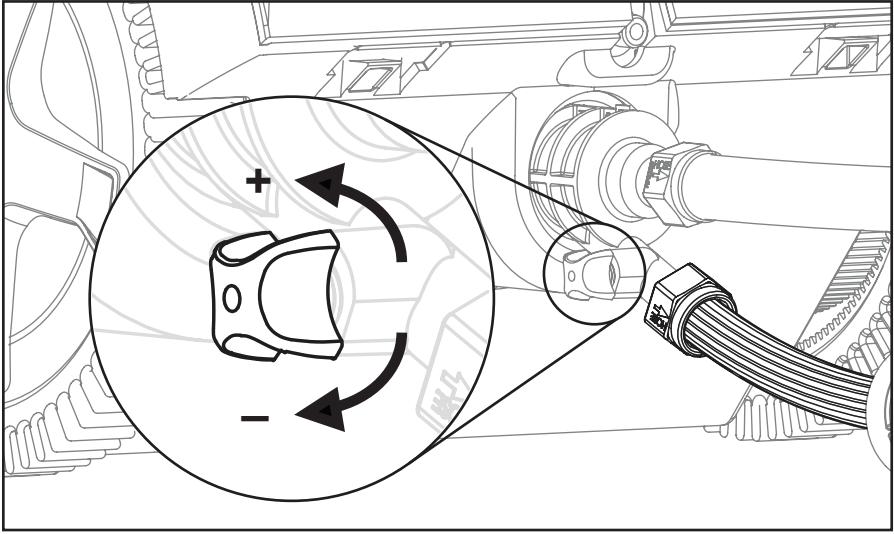

SWEEP HOSE MOVES SLOWLY OR NOT AT ALL:

Turn the adjustment knob **counter-clockwise** to **increase** sweep hose power.

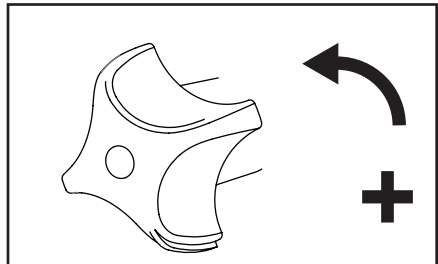

SWEEP HOSE FREQUENTLY SPRAYS OUT OF THE POOL:

Turn the adjustment knob **clockwise** to **reduce** sweep hose power.

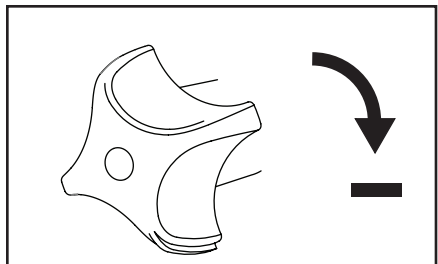

# DEBRIS BAG

## ATTACHING DEBRIS BAG

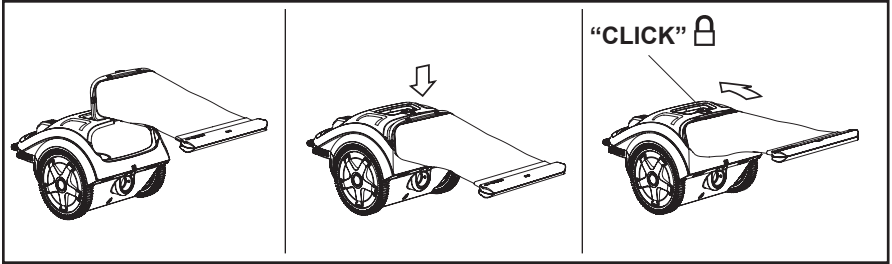

## REMOVING DEBRIS BAG

Push the top button and push back the bag then lift it up.

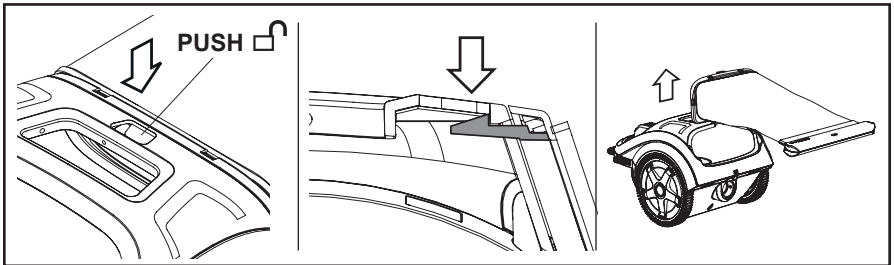

## CLEANING DEBRIS BAG

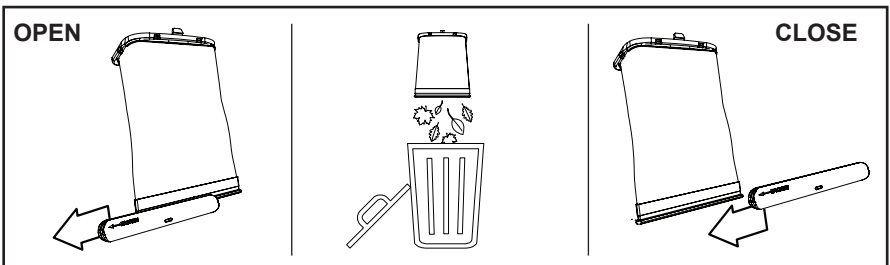

Full debris bag will reduce cleaner performance.



If the bag is allowed to dry, it will be easier to remove the debris.

# MAINTENANCE

## REMOVE CLEANER FROM POOL

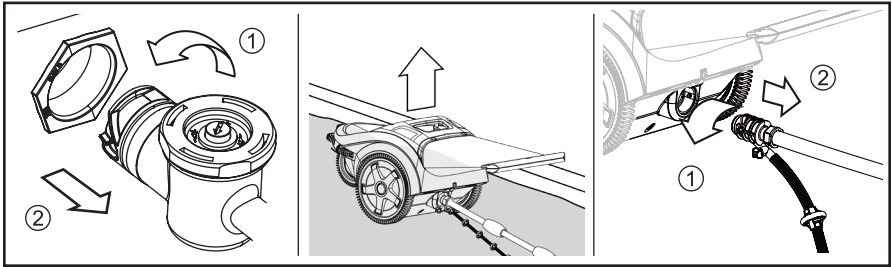
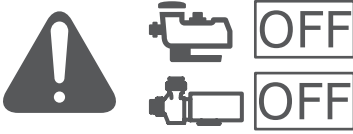

## CLEANING THE IN-LINE FILTER



If the screen frequently becomes plugged, the filtration system is not performing properly or there is another plumbing problem.

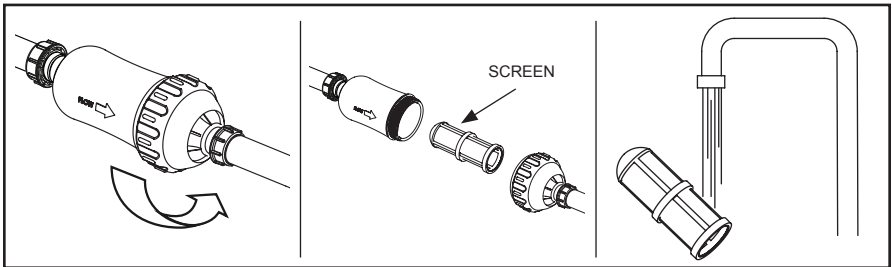
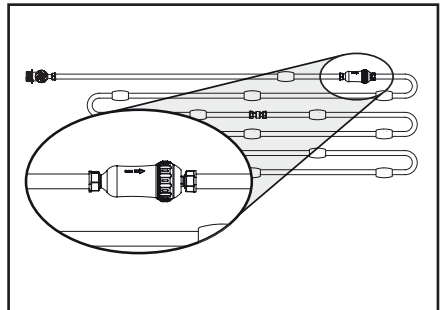

Make sure the o-ring is in place and properly seated.

# REPLACING PARTS

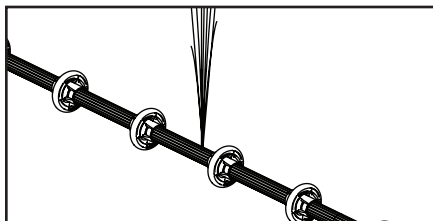

## SWEEP HOSE

If a hole forms in the sweep hose, it should be replaced. Unscrew the mender nut from the hose and pull the sweep hose off the cleaner connector. Attach a new sweep hose to the cleaner connector.

PART NUMBER: TVX7000HST-01

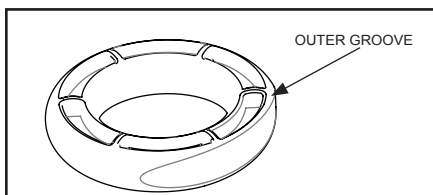

## SWEEP HOSE ROLLERS

The sweep hose rollers are wear parts. When the rollers wear-down to the outer groove (wear line) replace the wear roller.

PART NUMBER: TVX7081-01

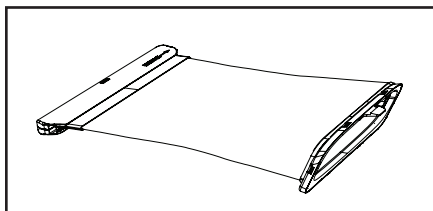

## DEBRIS BAG

The debris bag should be replaced if it is torn.

PART NUMBER:  
TriVac™ 500 TVX5000BA  
TriVac™ 700 TVX7000BA

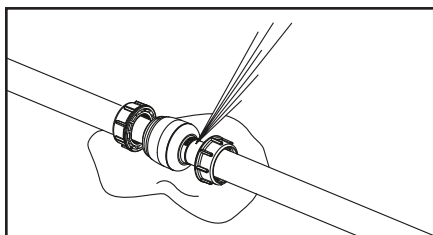

## SWIVELS

If a swivel ceases to turn easily or leaks while the cleaner is running, it should be replaced.

PART NUMBER:  
TVX7000SA-01

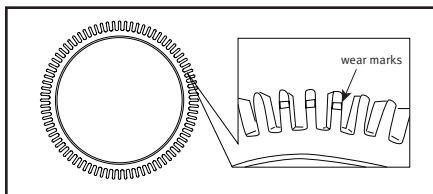

## TIRES

The tires are wear parts. When the tires wear-down to the wear marks replace the tire.

PART NUMBER:  
TVX7039-234

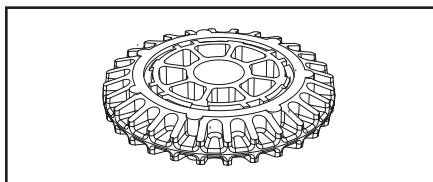

## SIDE ROLLERS

The side rollers are wear parts. When a side roller wears down, replace the side roller.

PART NUMBER:  
TVX7036-234 (X1)

# COLD WATER OPERATION



  $<55^{\circ}\text{F} / <12.8^{\circ}\text{C}$

When the water temperature drops below  $55^{\circ}\text{F} / 12.8^{\circ}\text{C}$ , the hose will stiffen, reducing the cleaners ability to turn during backup. This may prevent the cleaner from escaping obstacles.

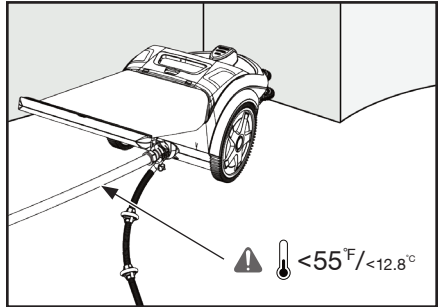

## NOZZLE EXTENSION

Use of the nozzle extension may be required to increase the angle of the backup thrust jet which will increase the cleaners turn during backup.

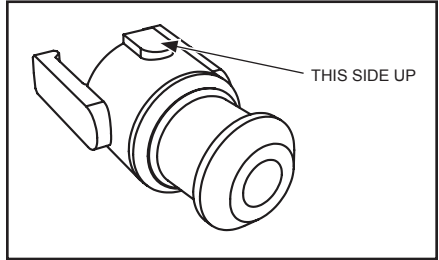

## INSTALLATION

To install the extension, make sure the slotted side is up and simply push it on to the back thrust jet nozzle until it clicks.

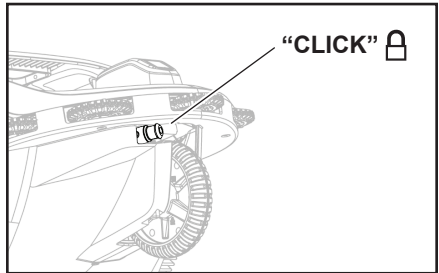
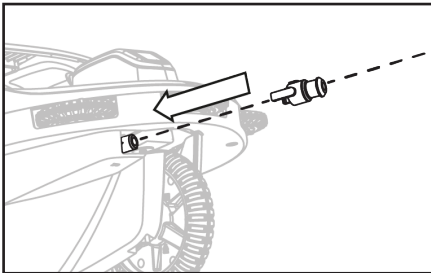

Do not leave the nozzle extension installed in warm water operation. Increased backup turn in warmer water could lead to hose tangles.

Simply pull out to remove.



# COLD WATER OPERATION

## CLEANER BEHAVIOR

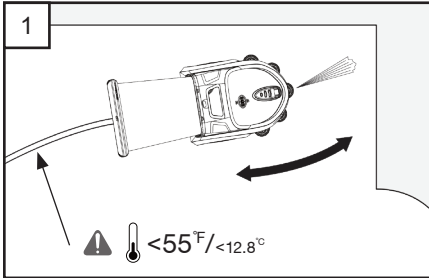

1. Behavior of the cleaner in cold water without the nozzle extension.

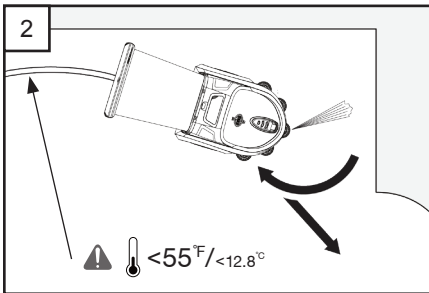

2. Behavior of the cleaner in cold water **with the nozzle extension**.

## SWEEP HOSE REMOVAL

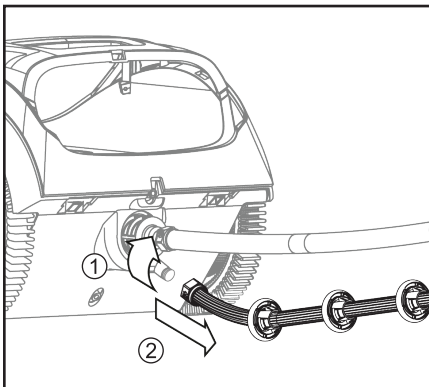

Removing the sweep hose can also help the cleaner changing direction in cold water. (Sweep hose is optional and operating the cleaner without it does not affect cleaning performance)

# TROUBLESHOOTING

## FOR TECHNICAL ASSISTANCE

CALL: 1-908-355-7995

PROBLEM	CAUSE	SOLUTION
Slow or no forward movement	Low or no water pressure	Check filtration and booster pumps, valves, cleaner connections. Check Cleaner pressure. (backwash)
Cleaner does not reach farthest point in pool	Hose too short	Add extra hose section if necessary <b>(page 6-9)</b>
Cleaner unable to clear obstacles (stairs, steps...)	Hose too short	Add extra hose section <b>(page 6-9)</b>
Hose frequently tangles	Float not properly placed	Check position of floats on the hose (see diagram) <b>(page 19)</b>
	Hose too long	Check hose length <b>(page 6-8)</b>
	Sweep hose not moving	Check sweep hose for holes or clogs, increase sweep hose power.
Sweep hose sprays out of pool	Sweep hose power too strong	Reduce sweep hose power <b>(page 12)</b>
Little or no sweep hose movement	Sweep hose power too weak	Increase hose power <b>(page 12)</b>
	Hole in sweep hose	Replace sweep hose
	Debris clogging sweep hose	Disconnect sweep hose and flush out
TriVac™ running on side or upside down	Heavy debris	Empty Bag
	Incorrect pressure setting	Check operating pressure <b>(page 10)</b>
Cleaner cannot climb to the surface in TOP mode	Incorrect pressure setting	Check operating pressure <b>(page 10)</b>
	Too much heavy debris in bag	Empty bag
Cleaner runs in small circles	Hose assembly bent	Layout in sun until straight <b>(page 5)</b>
Cleaner get stuck on shallow area of pools (beach entry, tanning shelf...)	The sweep hose may interfere with obstacle	Operate the cleaner without the sweep hose
Cleaner inability to recover from obstacle or specific areas	The sweep hose may interfere with obstacle	Operate the cleaner without the sweep hose
	Operating pressure too low	Check operating pressure <b>(page 10)</b>
Cleaner does not cover the entire pool	The sweep hose affects cleaning pattern of cleaner	Operate the cleaner without the sweep hose

# PRESSURE HOSE

