

# EASY TEMP

**POMPE A CHALEUR POUR PISCINE  
SWIMMING POOL HEAT PUMP UNIT  
UNIDAD DE BOMBA DE CALOR PARA PISCINAS  
BOMBA DE AQUECIMENTO PARA PISCINAS  
HEIZPUMPENANLAGE FÜR EIN SCHWIMMBECKEN  
ZWEMBAD WARMTEPOMP  
UNITÀ DI RISCALDAMENTO A POMPA DI CALORE PER PISCINE  
VARMEPUMPE TIL SVØMMEBASSENG  
LÄMPÖPUMPPU UIMA-ALTAALLE  
VÄRMEPUMP FÖR BASSÄNG  
ТЕПЛОВОЙ НАСОС ДЛЯ ПЛАВАТЕЛЬНОГО БАССЕЙНА**

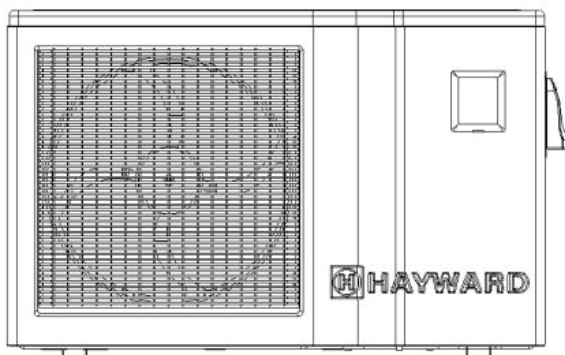

**Manuel d'instructions et d'installation  
Installation & Instruction Manual  
Manual de Instalación e Instrucciones  
Manual de instalação e de instruções  
Einbau- & Anleitungshandbuch  
Installatie- en bedieningshandleiding  
Manuale d'Uso e di Installazione  
Installerings- og brukerveiledning  
Asennus- ja ohjekirja  
Bruksanvisning och installationsmanual  
Руководство по монтажу и эксплуатации**

# EASY TEMP

POMPE A CHALEUR POUR PISCINE

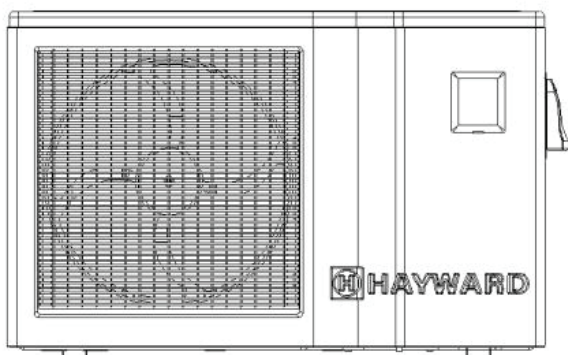

Manuel d'instructions et d'installation

# SOMMAIRE

---

<b>1. Préface</b>	<b>1</b>
<hr/>	
<b>2. Caractéristiques techniques</b>	<b>2</b>
2.1 Données techniques de la pompe à chaleur	2
2.2 Plage de fonctionnement	3
2.3 Dimensions	4
<hr/>	
<b>3. Installation et raccordement</b>	<b>5</b>
3.1 Schéma de principe	5
3.2 Pompe à chaleur	5
3.3 Raccordement hydraulique	6
3.4 Raccordement électrique	7
3.5 Premier démarrage	8
3.6 Réglage du débit d'eau	10
<hr/>	
<b>4. Interface utilisateur</b>	<b>11</b>
4.1 Présentation générale	11
4.2 Réglage de l'horloge	13
4.3 Réglage de la fonction Timer	13
4.4 Choix du mode de fonctionnement : chauffage ou refroidissement	14
4.5 Réglage et visualisation du point de consigne	15
4.6 Verrouillage et déverrouillage de l'interface utilisateur	15
<hr/>	
<b>5. Entretien et Hivernage</b>	<b>16</b>
5.1 Entretien	16
5.2 Hivernage	16
<hr/>	
<b>6. Annexes</b>	<b>17</b>
6.1 Schémas Électriques	17
6.2 Raccordements priorité chauffage	22
6.3 Vues éclatées et pièces détachées	23
6.4 Guide de dépannage	33
6.5 Garantie	34

À lire attentivement et à conserver pour une consultation ultérieure.

Ce document doit être remis au propriétaire de la piscine et doit être conservé par celui-ci en lieu sûr.

# 1. PREFACE

---

Nous vous remercions d'avoir acheté cette pompe à chaleur de piscine Easy Temp. Ce produit a été conçu selon des normes strictes de fabrication pour satisfaire aux niveaux de qualité requis. Le présent manuel inclut toutes les informations nécessaires concernant l'installation, l'élimination des dysfonctionnements et l'entretien. Lisez attentivement ce manuel avant d'ouvrir l'unité, ou de réaliser des opérations d'entretien sur celle-ci. Le fabricant de ce produit ne sera en aucun cas tenu responsable en cas de blessure d'un utilisateur ou d'un endommagement de l'unité suite à d'éventuelles erreurs lors de l'installation, de l'élimination des dysfonctionnements, ou d'un entretien inutile. Il est primordial de suivre à tout moment les instructions spécifiées dans ce manuel. L'unité doit être installée par un personnel qualifié.

- Les réparations doivent être effectuées par un personnel qualifié.
- Tous les raccordements électriques doivent être effectués par un électricien professionnel qualifié et selon les normes en vigueur dans le pays d'installation cf § 3.4.
- L'entretien et les différentes opérations doivent être réalisés à la fréquence et aux moments recommandés, tel que spécifié dans le présent manuel.
- N'utilisez que des pièces détachées d'origine.
- Toute recommandation non suivie annule la garantie.
- Cette pompe à chaleur réchauffe l'eau de la piscine, et maintient une température constante, ne pas l'utiliser à d'autres fins.

Après avoir lu ce manuel, rangez le en vue d'une utilisation ultérieure.  
Avertissements concernant les enfants / personnes à capacité physique réduite :

Cet appareil n'est pas destiné à être utilisé par des personnes (notamment des enfants) dont les capacités physiques, sensorielles ou intellectuelles sont réduites, ou par des personnes manquant d'expérience ou de connaissances, à moins que celles-ci ne soient sous surveillance ou qu'elles aient reçu des instructions quant à l'utilisation de l'appareil par une personne responsable de leur sécurité.

Ce produit contient des gaz à effet de serre fluorés encadrés par le protocole de Kyoto.

Type de réfrigérant : R410A

Valeur GWP<sup>(1)</sup> : 1975

Des inspections périodiques de fuite de réfrigérant peuvent être exigées en fonction de la législation européenne ou local. Veuillez contacter votre distributeur local pour plus d'informations.

---

(1) Potentiel de réchauffement global

## 2. CARACTÉRISTIQUES TECHNIQUES

### 2.1 Données techniques de la pompe à chaleur

Modèle	EASY TEMP	ECP 06	ECP 08	ECP 11	ECP 13	ECP 15
Capacité calorifique *	kW BTU/h	5,5 18785	8 27322	11 37566	13.5 46105	15 51228
Puissance électrique	kW	1,17	1,8	2,43	3	3,13
Courant de fonctionnement *	A	5,19	7,91	11,81	14,5	16
Alimentation électrique	V Ph/Hz	230 V ~ 1 / 50Hz	230 V ~ 1 / 50Hz	230 V ~ 1 / 50Hz	230 V ~ 1 / 50Hz	230 V ~ 1 / 50Hz
Calibre fusible type aM	A	8 aM	10 aM	16 aM	20 aM	20 aM
Disjoncteur courbe D	A	8 D	10 D	16 D	20 D	20 D
Nombre de compresseurs		1	1	1	1	1
Type de compresseur		Rotatif	Rotatif	Rotatif	Scroll	Scroll
Nombre de ventilateurs		1	1	1	1	1
Puissance du ventilateur	W	50	120	120	120	120
Vitesse de rotation du ventilateur	RPM	770	850	850	850	850
Direction du ventilateur		Horizontale	Horizontale	Horizontale	Horizontale	Horizontale
Niveau de pression sonore (à 1 mètre)	dB(A)	47	51	54	56	56
Raccordement hydraulique	mm	50	50	50	50	50
Débit d'eau	m³/h	2,3	3,0	4,5	5,3	6,6
Perte de charge sur l'eau (max)	kPa	5,4	8,9	19,2	5,2	39,9
Dimensions nettes de l'unité (L//h)	mm	895/375/545	1035/415/650	1035/415/650	1136/440/870	1136/440/870
Dimensions de l'unité emballée (L//h)	mm	970/430/710	1120/480/810	1180/480/810	1230/510/1020	1230/510/1020
Poids net / poids de l'unité emballée	kg	45/56	54/68	60/74	95/115	117/128



\* Valeur à +/- 5% aux conditions suivantes: Température extérieur = 24°C (75°F) / HR=62% / Température de la piscine=27°C (80°F)

## 2. CARACTÉRISTIQUES TECHNIQUES (suite)

---

### 2.2 Plage de fonctionnement

Utiliser la pompe à chaleur dans les plages suivantes de températures et d'humidité pour assurer un fonctionnement sûr et efficace.

	Mode chauffage 	Mode Refroidissement 
Température extérieure	+2°C ~ +35°C	+7°C ~ +43°C
Température d'eau	+12°C ~ +40°C	+8°C ~ +40°C
Humidité relative	< 80%	< 80%
Plage de réglage point de consigne	+15°C ~ +40°C	+8°C ~ +35°C



***Si la température ou l'humidité ne correspond pas à ces conditions, des dispositifs de sécurité peuvent se déclencher et la pompe à chaleur peut ne plus fonctionner.***

## 2. CARACTÉRISTIQUES TECHNIQUES (suite)

### 2.3 Dimensions

Modèles : ECP06 / ECP08 / ECP11 / ECP13 / ECP15

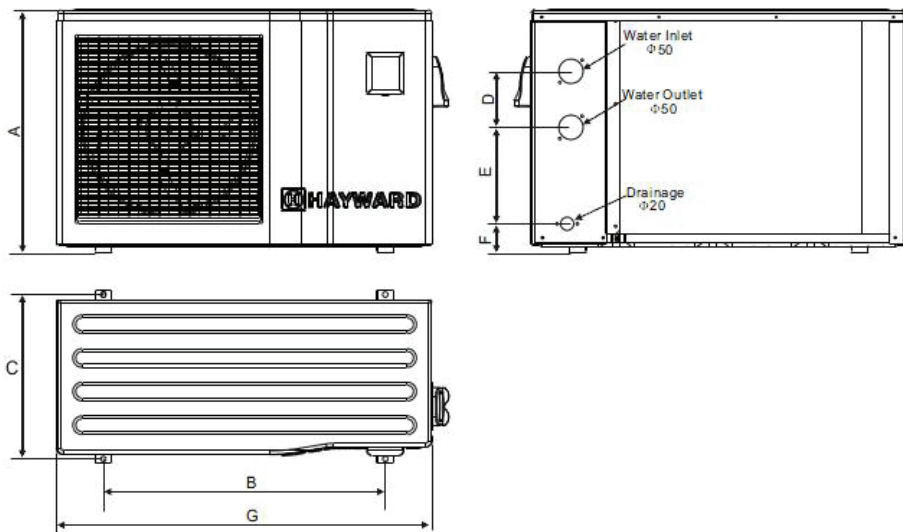

Unité : mm

Modèle Repère	ECP06	ECP08 ECP11	ECP13 ECP15
<b>A</b>	540	648	866
<b>B</b>	571	755	840
<b>C</b>	400	440	470
<b>D</b>	140	150	150
<b>E</b>	258	258	330
<b>F</b>	66	77	80
<b>G</b>	860	1004	1114

## 3. INSTALLATION ET RACCORDEMENT

### 3.1 Schéma de Principe

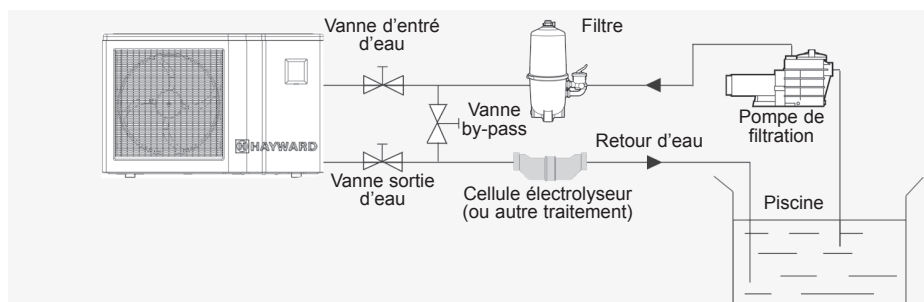

Note : La pompe à chaleur est fournie sans aucun équipement de traitement ou de filtration. Les éléments présentés sur le schéma sont des pièces à fournir par l'installateur.

### 3.2 Pompe à chaleur



**Placer la pompe à chaleur à l'extérieur et en dehors de tout local technique fermé.**

**Placée sous abri, les distances minimum prescrites ci-dessous doivent être respectées afin d'éviter tout risque de recirculation d'air et une dégradation des performances globales de la pompe à chaleur.**

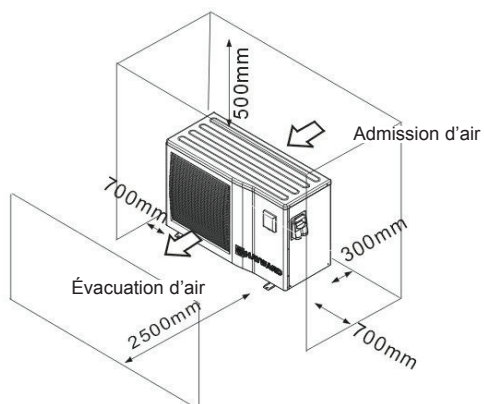



### 3. INSTALLATION ET RACCORDEMENT (suite)

---



**Installer de préférence la pompe à chaleur sur une dalle béton désolidarisée ou une chaise de fixation prévue à cet effet et monter la pompe à chaleur sur les silentblochs fournis (visserie et rondelles non fournies).**

**Distance maximale d'installation entre la pompe à chaleur et la piscine 15 mètres.**

**Longueur totale aller-retour des canalisations hydrauliques 30 mètres.**

**Isoler les canalisations hydrauliques de surface et enterrées.**

#### 3.3 Raccordement hydraulique

La pompe à chaleur est fournie avec deux raccords union diamètre 50 mm. Utiliser du tube PVC pour canalisation hydraulique Ø 50 mm. Raccorder l'entrée d'eau de la pompe à chaleur à la conduite venant du groupe de filtration puis raccorder la sortie d'eau de la pompe à chaleur à la conduite d'eau allant au bassin (cf schéma ci-dessous).

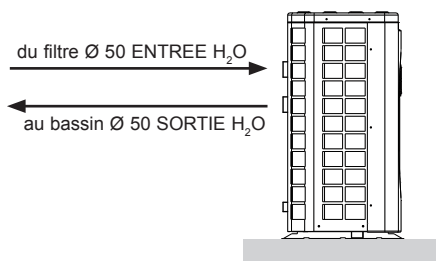

Installer une vanne dite "by-pass" entre l'entrée et la sortie de la pompe à chaleur.



**Si un distributeur automatique ou un électrolyseur est utilisé, il doit impérativement être installé après la pompe à chaleur dans le but de protéger le condenseur Titane contre une concentration trop importante de produit chimique.**



**Veillez à bien installer la vanne by-pass et les raccords union fournis au niveau de l'entrée et de la sortie d'eau de l'unité, afin de simplifier la purge durant la période hivernale, d'en faciliter l'accès ou son démontage pour l'entretien.**

### 3. INSTALLATION ET RACCORDEMENT (suite)

#### 3.4 Raccordement Électrique



**L'installation électrique et le câblage de cet équipement doivent être conformes aux règles d'installation locales en vigueur.**

F	NF C15-100	GB	BS7671:1992
D	DIN VDE 0100-702	EW	EVHS-HD 384-7-702
A	ÖVE 8001-4-702	H	MSZ 2364-702/1994/MSZ 10-553 1/1990
E	UNE 20460-7-702 1993, RECBT ITC-BT-31 2002	M	MSA HD 384-7-702.S2
IRL	Wiring Rules + IS HD 384-7-702	PL	PN-IEC 60364-7-702:1999
I	CEI 64-8/7	CZ	CSN 33 2000 7-702
LUX	384-7.702 S2	SK	STN 33 2000-7-702
NL	NEN 1010-7-702	SLO	SIST HD 384-7-702.S2
P	RSIUEE	TR	TS IEC 60364-7-702



**Vérifiez que l'alimentation électrique disponible et la fréquence du réseau correspondent au courant de fonctionnement requis, en prenant en considération l'emplacement spécifique de l'appareil, et le courant nécessaire pour alimenter tout autre appareil connecté au même circuit.**

**ECP 06 230 V~ +/- 10 % 50 HZ 1 Phase**

**ECP 08 230 V~ +/- 10 % 50 HZ 1 Phase**

**ECP 11 230 V~ +/- 10 % 50 HZ 1 Phase**

**ECP 13 230 V~ +/- 10 % 50 HZ 1 Phase**

**ECP 15 230 V~ +/- 10 % 50 HZ 1 Phase**

**Observez le schéma de câblage correspondant en annexe.**

**Le boîtier de raccordement se trouve du côté droit de l'unité. Trois connexions sont destinées à l'alimentation électrique, et deux à la commande de la pompe de filtration (Asservissement).**

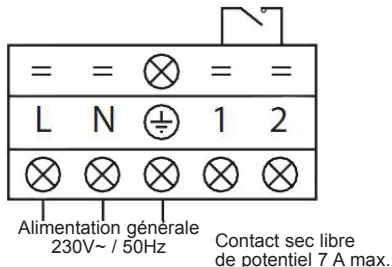

## 3. INSTALLATION ET RACCORDEMENT (suite)

---



**La ligne d'alimentation électrique doit être dotée, de manière appropriée, d'un dispositif de protection fusible de type alimentation moteur (aM) ou disjoncteur courbe D ainsi que d'un disjoncteur différentiel 30mA (voir tableau après).**

Modèles		ECP 06	ECP 08	ECP 11	ECP 13	ECP 15
Alimentation électrique	V/Ph/ Hz	230 V~ 1/50 Hz	230 V~ 1/50 Hz	230 V~ 1/50 Hz	230 V~ 1/50 Hz	230 V~ 1/50 Hz
Calibre fusible type aM	A	8 aM	10 aM	16 aM	20 aM	20 aM
Disjoncteur courbe D	A	8 D	10 D	16 D	20 aM	20 aM



**Prenez toujours garde d'arrêter l'alimentation principale avant d'ouvrir la boîte de commande électrique.**

### 3.5 Premier démarrage

Procédure de démarrage - une fois l'installation terminée, suivez et respectez les étapes suivantes :

- 1) Faites pivoter le ventilateur à la main afin de vérifier qu'il peut tourner librement, et que l'hélice est fixée correctement sur l'arbre du moteur.
- 2) Assurez-vous que l'unité est connectée correctement à l'alimentation principale (voir le schéma de câblage en annexe).
- 3) Activez la pompe de filtration.
- 4) Vérifiez que toutes les vannes d'eau sont ouvertes, et que l'eau s'écoule vers l'unité avant de passer en mode chauffage ou refroidissement.
- 5) Vérifiez que le tuyau de purge des condensats est fixé correctement, et ne présente aucune obstruction.
- 6) Activez l'alimentation électrique destinée à l'unité, puis appuyez sur le bouton Marche/Arrêt  sur le panneau de commande.

### 3. INSTALLATION ET RACCORDEMENT (suite)

---

- 7) Assurez-vous qu'aucun code d'ALARME ne s'affiche lorsque l'unité est sur ON (voir guide de dépannage).
- 8) Fixez le débit d'eau à l'aide de la vanne by-pass (voir § 3.6 et 2.1), tel que prévu respectivement pour chaque modèle, de manière à obtenir une différence de température Entrée/Sortie de 2°C.
- 9) Après un fonctionnement de quelques minutes, vérifiez que l'air sortant de l'unité s'est refroidi (entre 5 et 10°).
- 10) L'unité étant en service, désactivez la pompe de filtration. L'unité doit s'arrêter automatiquement et afficher le code d'erreur E03.
- 11) Faites fonctionner l'unité et la pompe de la piscine 24 heures sur 24, jusqu'à ce que la température de l'eau souhaitée soit atteinte. Quand la température d'entrée d'eau atteint la valeur de consigne, l'unité s'arrête. Elle redémarre alors automatiquement (tant que la pompe de la piscine est en service) si la température de la piscine est inférieure d'au moins 0.5°C à la température de consigne.

**Contrôleur de débit** - L'unité est dotée d'un contrôleur de débit qui active la pompe à chaleur lorsque la pompe de filtration de la piscine est en service, et la désactive lorsque la pompe de la filtration est hors service. Par manque d'eau, le code d'alarme E03 s'affiche sur le régulateur (Voir § 6.4).

**Temporisation** - l'unité intègre une temporisation de 3 minutes, afin de protéger les composants du circuit de commande, d'éliminer toute instabilité en terme de redémarrage et, toute interférence au niveau du contacteur. Grâce à cette temporisation, l'unité redémarre automatiquement 3 minutes environ après toute coupure du circuit de commande. Même une coupure de courant de courte durée active la temporisation de démarrage.

### 3. INSTALLATION ET RACCORDEMENT (suite)

#### 3.6 Réglage du débit d'eau

Lorsque la pompe à chaleur est en fonctionnement et les vannes d'entrée et de sortie d'eau ouvertes, ajuster la vanne dite "by-pass" de façon à obtenir une différence de 2°C entre la température d'entrée et de sortie d'eau (voir schéma de principe § 3.1). Vous pouvez vérifier le réglage en visualisant les températures entrée (T02) / sortie (T03) directement sur le panneau de commande en suivant la procédure ci-dessous.

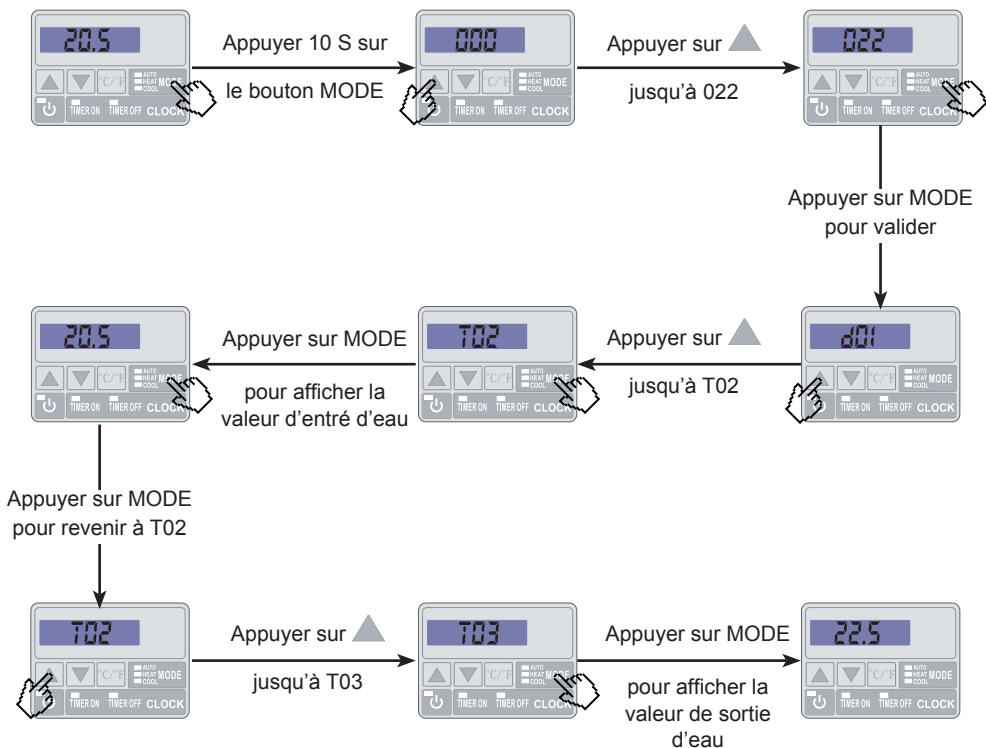

Puis, régler votre By-pass afin d'obtenir une différence de 2°C entre T03 et T02 ( $T03 - T02 = \Delta T = 2$ ).

Appuyer 2 fois sur  pour sortir du menu

Note : L'ouverture de la vanne dite "by-pass" engendre un débit moins important d'où une augmentation du  $\Delta T$ .

La fermeture de la vanne dite "by-pass" engendre un débit plus important d'où une diminution du  $\Delta T$ .

## 4. INTERFACE UTILISATEUR







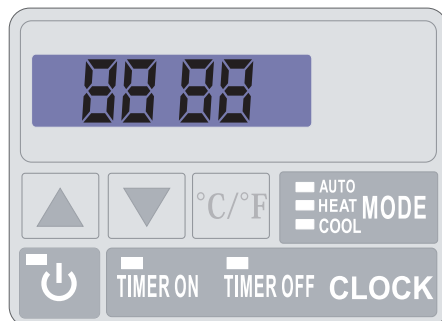

---

### 4.1 Présentation générale

La pompe à chaleur est équipée d'un panneau de commande électronique, raccordé électriquement et pré-réglé en usine en mode chauffage.



#### Légende

-  **COOL** Symbole Mode Refroidissement
-  **HEAT** Symbole Mode Chauffage
-  **AUTO** Mode automatique
-  **CLOCK** Réglage heure et Timer
-  **MODE** Bouton sélection et réglage
-  Bouton Marche/Arrêt et retour/validation
-  Défilement bas
-  Défilement haut
-  **TIMER ON** Réglage heure de marche
-  **TIMER OFF** Réglage heure d'arrêt

## 4. INTERFACE UTILISATEUR (suite)

---

### Mode OFF

Lorsque la pompe à chaleur est en veille (Mode OFF) l'heure ainsi que le mode de fonctionnement sont affichés sur l'écran du régulateur.

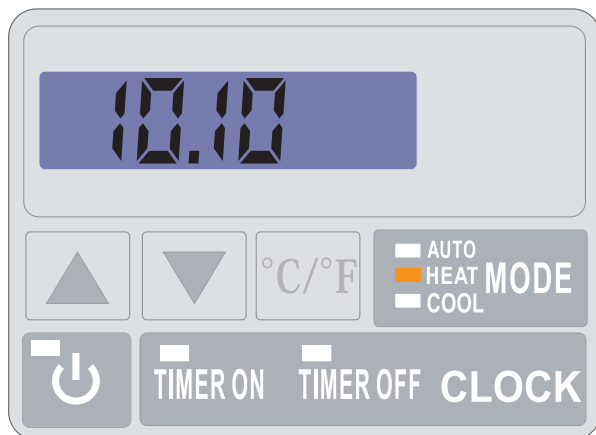

### Mode ON



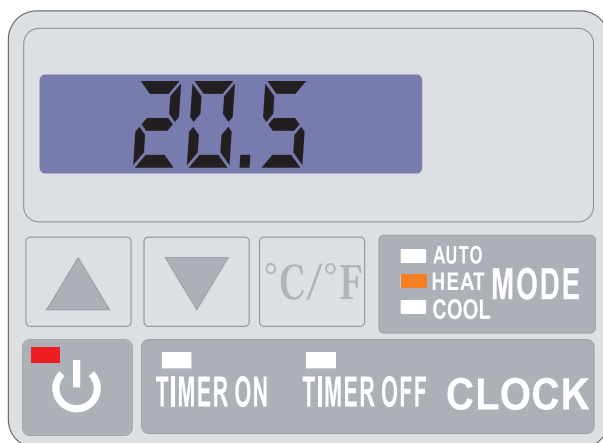

Lorsque la pompe à chaleur est en fonctionnement ou en régulation (Mode ON) la voyant du bouton marche est allumé en rouge et la température d'entrée d'eau s'affiche sur l'écran.



## 4. INTERFACE UTILISATEUR (suite)

---

### 4.2 Réglage de l'horloge





Le réglage de l'horloge peut se faire en mode ON ou OFF. Presser «CLOCK», l'affichage clignote puis appuyer sur «CLOCK», les heures clignotent. Régler les heures avec les flèches  ou  puis presser encore une fois «CLOCK» pour sélectionner les minutes. Régler les minutes à l'aide des flèches  ou . Presser «CLOCK» pour valider. L'afficheur revient à son état précédent.

Note : La sauvegarde des réglages se fait par le bouton «CLOCK» ou automatiquement si aucune touche n'est activée pendant 5 secondes.

### 4.3 Réglage de la fonction Timer





Le réglage de cette fonction est nécessaire dès lors que vous souhaitez faire fonctionner votre pompe à chaleur sur une plus courte période que celle définie par l'horloge de filtration. Ainsi vous pourrez programmer un départ différé et un arrêt anticipé ou simplement interdire une plage horaire de fonctionnement (par exemple la nuit).

#### Programmation Départ (Timer ON) / Marche

- 1) Presser «Timer ON», l'heure clignote.
- 2) Presser «Timer ON» pour régler les heures à l'aide des boutons  .
- 3) Presser «Timer ON» pour régler les minutes à l'aide des boutons  .

La sauvegarde des réglages se fait par le bouton «Timer ON» ou automatiquement si aucune touche n'est activée pendant 5 secondes. Un voyant vert indique que le timer est activé.

#### Programmation Arrêt (Timer OFF) / Arrêt

- 1) Presser «Timer OFF», l'heure clignote.
- 2) Presser «Timer OFF» pour régler les heures à l'aide des boutons  .
- 3) Presser «Timer OFF» pour régler les minutes à l'aide des boutons  .



La sauvegarde des réglages se fait par le bouton «Timer OFF» ou automatiquement si aucune touche n'est activée pendant 5 secondes. Un voyant rouge indique que le timer est activé.



## 4. INTERFACE UTILISATEUR (suite)

---

### Suppression des Timer (Timer ON et OFF) / Arrêt et Marche

- 1) Presser «Timer ON», «Timer ON» clignote.
- 2) Presser  pour supprimer la programmation.
- 3) Presser «Timer OFF», «Timer OFF» clignote.
- 4) Presser  pour supprimer la programmation.

### 4.4 Choix du mode de fonctionnement : chauffage, refroidissement ou automatique.

#### En Mode “OFF” ou “ON”

Presser le bouton «MODE» pour basculer du mode refroidissement (voyant vert) au mode chauffage (voyant orange) au mode automatique (voyant rouge).





## 4. INTERFACE UTILISATEUR (suite)

---



### 4.5 Réglage et visualisation du point de consigne (Température d'eau souhaitée)

#### En Mode "OFF" et Mode "ON"

Presser les boutons  ou  pour définir le point de consigne souhaité.  
Le réglage s'effectue avec une précision de 0,5 °C.



*Il est recommandé de ne jamais dépasser la température de 30°C pour éviter l'altération des liners.*

Note : En fonctionnement ou à l'arrêt il suffit de presser le bouton  ou  pour visualiser ou modifier le point de consigne.

### 4.6 Verrouillage et déverrouillage de l'écran tactile

Presser le bouton Marche/Arrêt  5 s jusqu'à l'émission d'un bip. Les touches deviennent inactives.

Pour déverrouiller, presser  5 s jusqu'à l'émission d'un bip.  
Les touches redeviennent actives.

## 5. ENTRETIEN ET HIVERNAGE

---

### 5.1 Entretien

Ces opérations de maintenance doivent être réalisées 1 fois par an afin de garantir la longévité et le bon fonctionnement de la pompe à chaleur.

- Nettoyer l'évaporateur à l'aide d'une brosse souple ou d'un jet d'air ou d'eau (**Attention ne jamais utiliser un nettoyeur haute pression**).
- Vérifier le bon écoulement des condensats.
- Vérifier le serrage des raccords hydrauliques et électriques
- Vérifier l'étanchéité hydraulique du condenseur.



***Avant toute opération de maintenance la pompe à chaleur doit être déconnectée de toute source de courant électrique. Les opérations de maintenance doivent être réalisées uniquement par un personnel qualifié et habilité à manipuler les fluides frigorigènes.***

### 5.2 Hivernage

- Mettre la pompe à chaleur en Mode "OFF".
- Couper l'alimentation de la pompe à chaleur.
- Vider le condenseur à l'aide de la vidange pour éviter tout risque de dégradation. (Risque important de gel).
- Fermer la vanne "by-pass" et dévisser les raccords unions entrée/sortie.
- Chasser au maximum l'eau stagnante résiduelle du condenseur à l'aide d'un pistolet à air.
- Obtenir l'entrée et la sortie d'eau sur la pompe à chaleur pour éviter l'intrusion de corps étrangers.
- Couvrir la pompe à chaleur avec une housse d'hivernage (non fournie).



***Tout dommage occasionné par un mauvais hivernage entraîne l'annulation de la garantie.***

# 6. ANNEXES

## 6.1 Schémas électriques

ECP 06

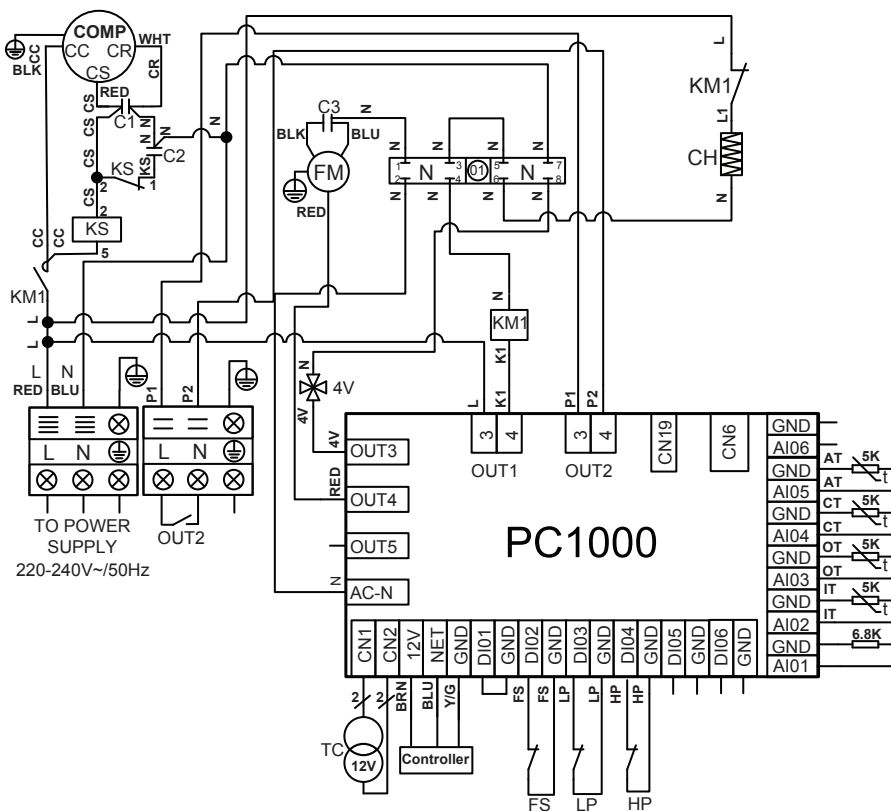

**REMARQUES :**

- AT : SONDE DE TEMPÉRATURE D'AIR
- COMP : COMPRESSEUR
- CT : SONDE TEMPÉRATURE ÉVAPORATEUR
- FM : MOTEUR VENTILATEUR
- FS : DÉTECTEUR PRÉSENCE D'EAU
- HP : PRESSOSTAT HAUTE PRESSION
- IT : SONDE DE TEMPÉRATURE ENTRÉE D'EAU

- LP : PRESSOSTAT BASSE PRESSION
- OT : SONDE DE TEMPÉRATURE SORTIE D'EAU
- TC : TRANSFORMATEUR 230V~/ 12V~
- 4V : VANNE 4 VOIES
- C1 : CONDENSATEUR COMPRESSEUR
- C2 : CONDENSATEUR VENTILATEUR
- OUT2: CONTACT SEC 7A MAX.

## 6. ANNEXES (suite)

ECP 08

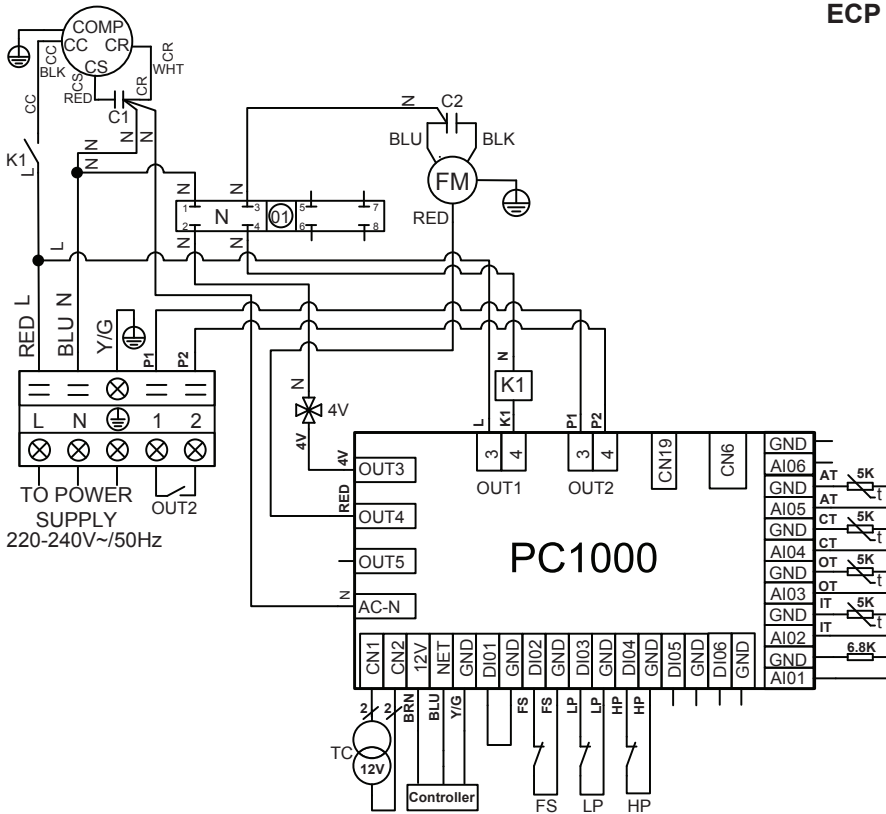

### REMARQUES :

AT : SONDE DE TEMPÉRATURE D'AIR

COMP : COMPRESSEUR

CT : SONDE TEMPÉRATURE ÉVAPORATEUR

FM : MOTEUR VENTILATEUR

FS : DÉTECTEUR PRÉSENCE D'EAU

HP : PRESSOSTAT HAUTE PRESSION

IT : SONDE DE TEMPÉRATURE ENTRÉE D'EAU

LP : PRESSOSTAT BASSE PRESSION

OT : SONDE DE TEMPÉRATURE SORTIE D'EAU

TC : TRANSFORMATEUR 230V~/ 12V~

4V : VANNE 4 VOIES

K1 : RELAIS COMPRESSEUR

C1 : CONDENSATEUR COMPRESSEUR

C2 : CONDENSATEUR VENTILATEUR

OUT2: CONTACT SEC 7A MAX.

## 6. ANNEXES (suite)

ECP 11

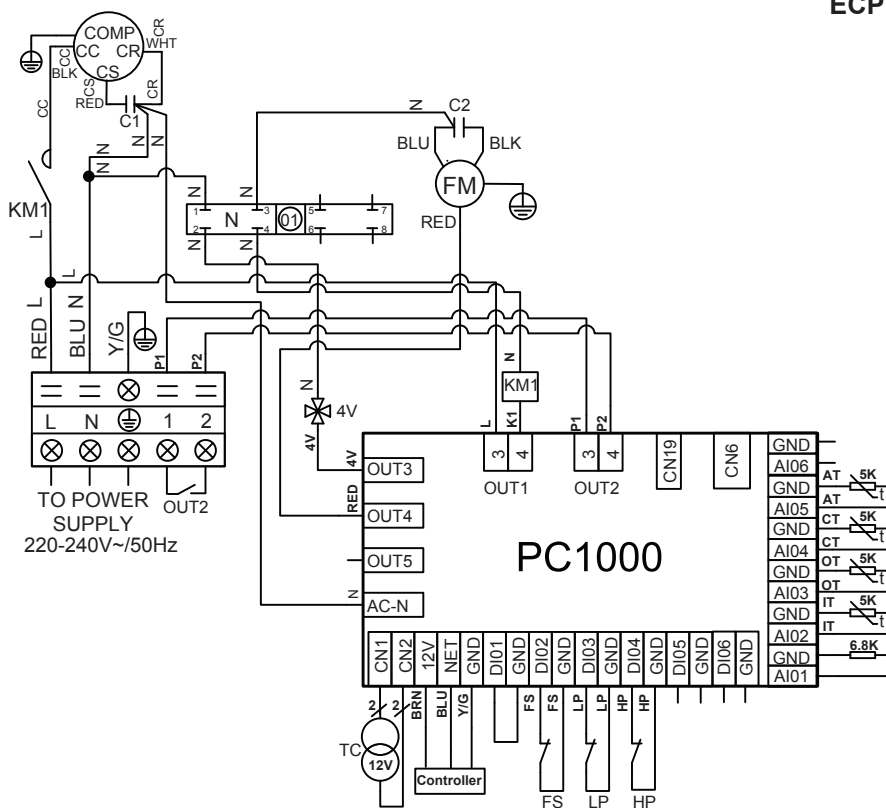

### REMARQUES :

AT : SONDE DE TEMPÉRATURE D'AIR  
 COMP : COMPRESSEUR  
 CT : SONDE TEMPÉRATURE ÉVAPORATEUR  
 FM : MOTEUR VENTILATEUR  
 FS : DÉTECTEUR PRÉSENCE D'EAU  
 HP : PRESSOSTAT HAUTE PRESSION  
 IT : SONDE DE TEMPÉRATURE ENTRÉE D'EAU

LP : PRESSOSTAT BASSE PRESSION  
 OT : SONDE DE TEMPÉRATURE SORTIE D'EAU  
 TC : TRANSFORMATEUR 230V~ / 12V~  
 4V : VANNE 4 VOIES  
 KM1: CONTACTEUR DE PUISSANCE COMPRESSEUR  
 C1:CONDENSATEUR COMPRESSEUR  
 C2:CONDENSATEUR VENTILATEUR  
 OUT2: CONTACT SEC 7A MAX.

## 6. ANNEXES (suite)

ECP 13

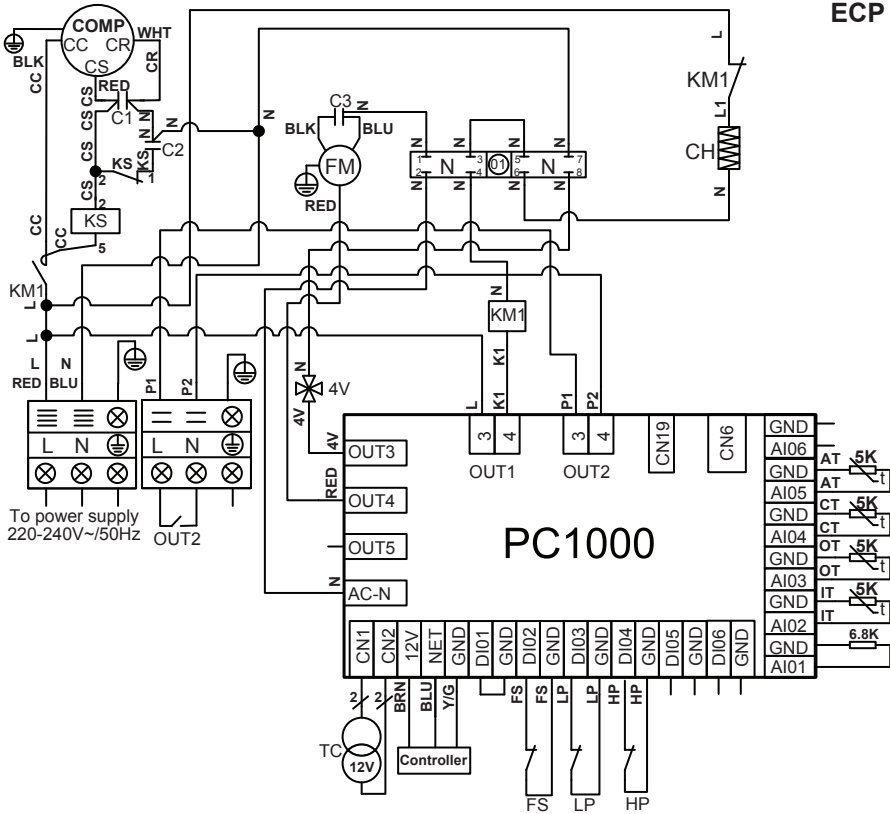

### REMARQUES :

AT : SONDE DE TEMPÉRATURE D'AIR

COMP : COMPRESSEUR

CH : RÉSISTANCE DE CARTER

CT : SONDE TEMPÉRATURE ÉVAPORATEUR

FM : MOTEUR VENTILATEUR

FS : DÉTECTEUR PRÉSENCE D'EAU

HP : PRESSOSTAT HAUTE PRESSION

IT : SONDE DE TEMPÉRATURE ENTRÉE D'EAU

KS : BOBINE DU RELAIS DE DÉMARRAGE DU COMPRESSEUR

LP : PRESSOSTAT BASSE PRESSION

OT : SONDE DE TEMPÉRATURE SORTIE D'EAU

TC : TRANSFORMATEUR 230V~/12V~

4V : VANNE 4 VOIES

KM1 : CONTACTEUR DE PUISSANCE COMPRESSEUR

C1 : CONDENSATEUR PERMANENT

C2 : CONDENSATEUR DE DÉMARRAGE

OUT2: CONTACT SEC 7A MAX.

## 6. ANNEXES (suite)

ECP 15

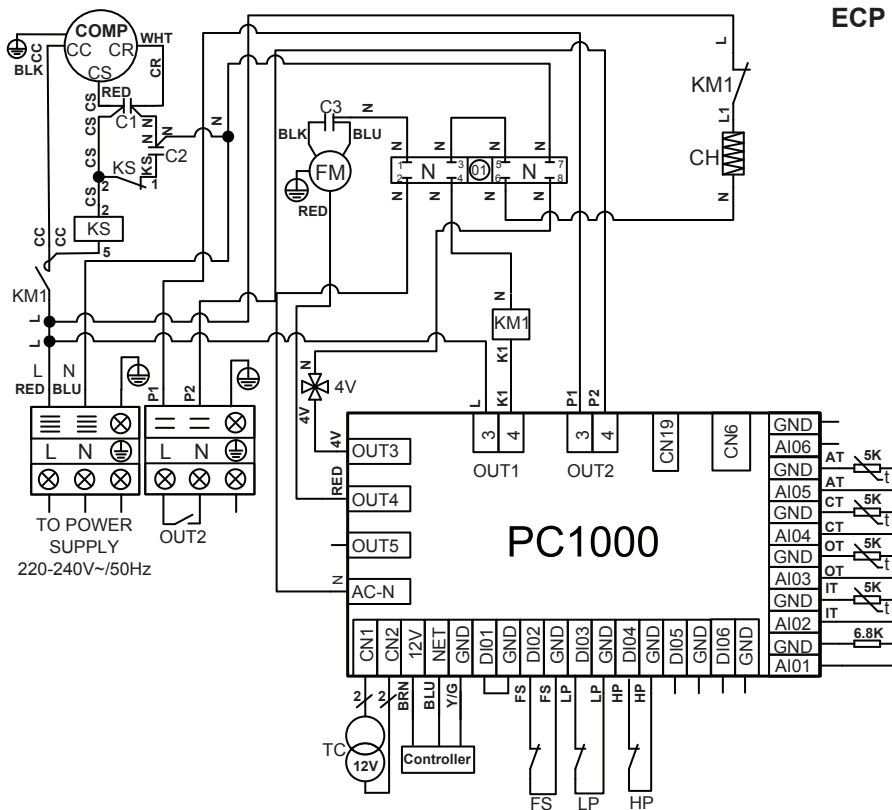

### REMARQUES :

AT : SONDE DE TEMPÉRATURE D'AIR  
 COMP : COMPRESSEUR  
 CH : RÉSISTANCE DE CARTER  
 CT : SONDE TEMPÉRATURE ÉVAPORATEUR  
 FM : MOTEUR VENTILATEUR  
 FS : DÉTECTEUR PRÉSENCE D'EAU  
 HP : PRESSOSTAT HAUTE PRESSION  
 IT : SONDE DE TEMPÉRATURE ENTRÉE D'EAU  
 KS : BOBINE DU RELAIS DE DÉMARRAGE DU COMPRESSEUR  
 LP : PRESSOSTAT BASSE PRESSION

OT : SONDE DE TEMPÉRATURE SORTIE D'EAU  
 TC : TRANSFORMATEUR 230V- / 12V-  
 4V : VANNE 4 VOIES  
 KM1 : CONTACTEUR DE PUISSANCE COMPRESSEUR  
 C1 : CONDENSATEUR PERMANENT  
 C2 : CONDENSATEUR DE DÉMARRAGE  
 OUT2: CONTACT SEC 7A MAX.



## 6. ANNEXES (suite)

### 6.2 Raccordements priorité chauffage Pompe Monophasé

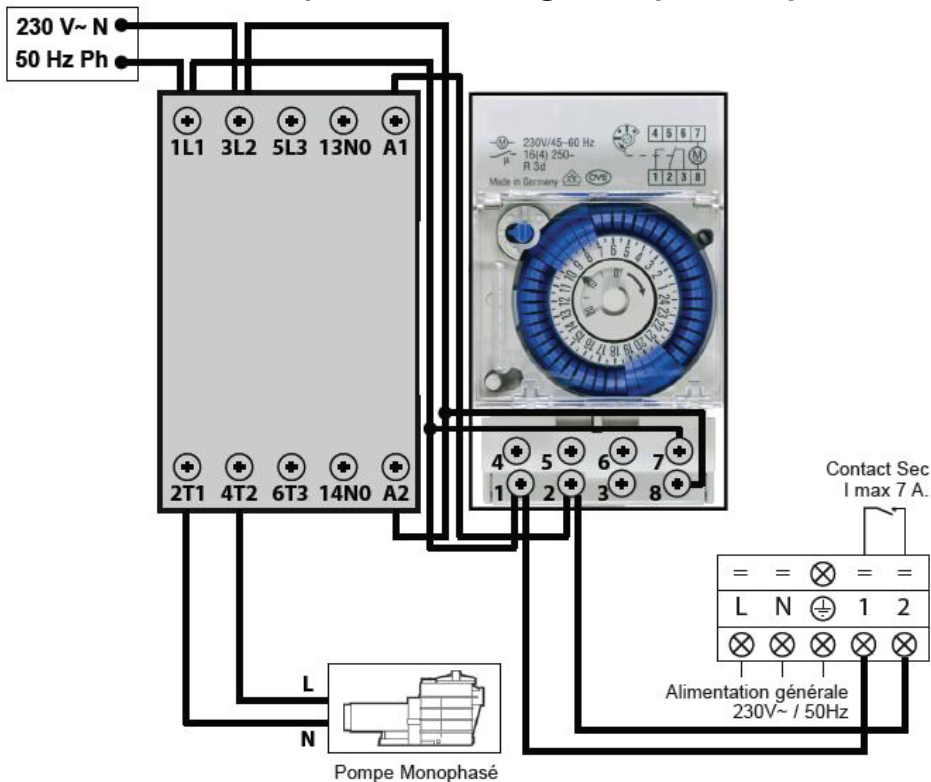

Les bornes 1-2 délivrent un contact sec libre de potentiel, sans polarité 230 V~ / 50 Hz.  
Câbler les bornes 1 et 2 en respectant le câblage indiqué ci-dessus afin d'assurer le fonctionnement de la pompe de filtration par cycle de 2 min. toutes les heures si la température du bassin est inférieure au point de consigne.

 Ne jamais raccorder l'alimentation de la pompe de filtration directement sur les bornes 1 et 2.



## 6. ANNEXES (suite)

### 6.3 Vues éclatées et pièces détachées

ECP 06

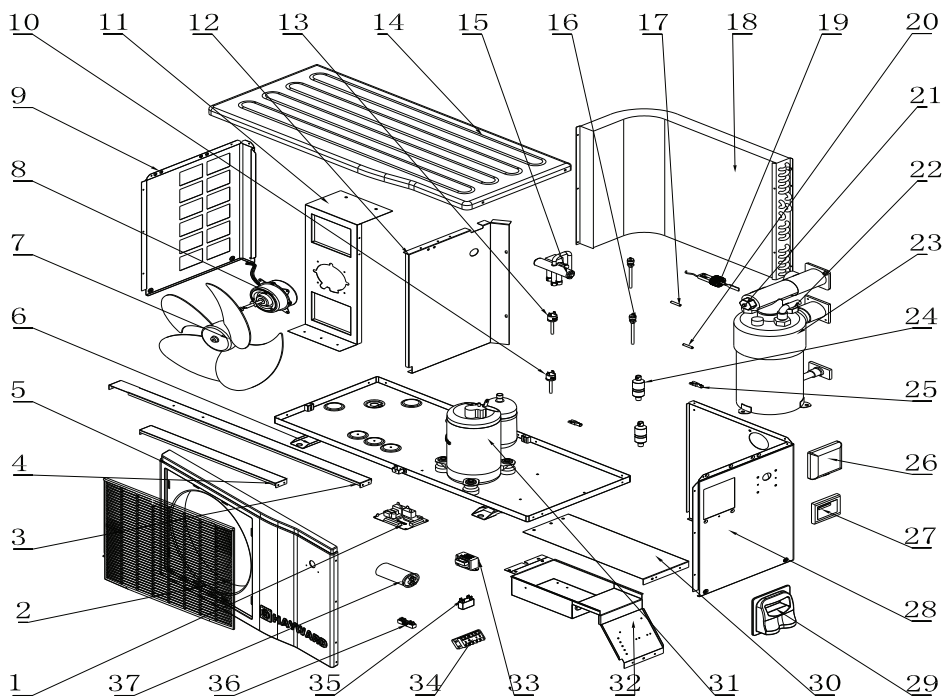

## 6. ANNEXES (suite)

### ECP 06

Rep	Réf.	Désignation	Rep	Réf.	Désignation
1	HWX950531145	Carte Electronique PC1000	20	HWX20003242	Sonde de température
2	HWX35252208	Grille	21	HWX20003242	Sonde de température
3	HWX322521062	Raidisseur Arrière	22	HWX20003242	Sonde de température
4	HWX322521063	Raidisseur Avant	23	HWX32251210	Condenseur Titane/PVC
5	HWX32025210084	Panneau ABS Avant	24	HWX20041444	Filtre (Ø9.7-Ø9.7)
6	HWX32025210081	Chassis	25	HWX200014068	Connecteur Capillaire
7	HWX34012701	Pale ventilateur	26	HWX20002111	Protection contrôleur
8	HWX34013301	Moteur ventilateur	27	HWX950531188	Contrôleur 7 segments
9	HWX32025210083	Panneau gauche	28	HWX32025210082	Panneau droit
10	HWX20003603	Pressostat Basse pression	29	HWX32009220054	Trappe d'accès électrique
11	HWX322521061	Support Moteur	30	HWX322521064	Panneau protection électrique
12	HWX322521059	Panneau de séparation	31	HWX200011006	Compresseur
13	HWX20013605	Pressostat Haute pression	32	HWX322521006	Coffret électrique
14	HWX32025210085	Panneau ABS Supérieur	33	HWX200037006	Transformateur 230V~/12V~
15	HWX20011418	Vanne 4 voies	34	HWX40003901	Bornier électrique 5 connexions
16	HWX200014153	Valve Shrader	35	HWX20003506	Condensateur ventilateur 2µF
17	HWX20003242	Sonde de température	36	HWX20003909	Bornier 2 connexions
18	HWX40001230	Evaporateur	37	HWX20003504	Condensateur compresseur 35µF
19	HWX200036005	Détecteur de débit	38	HWX20009910	Capillaire

## 6. ANNEXES (suite)

---

### ECP 08

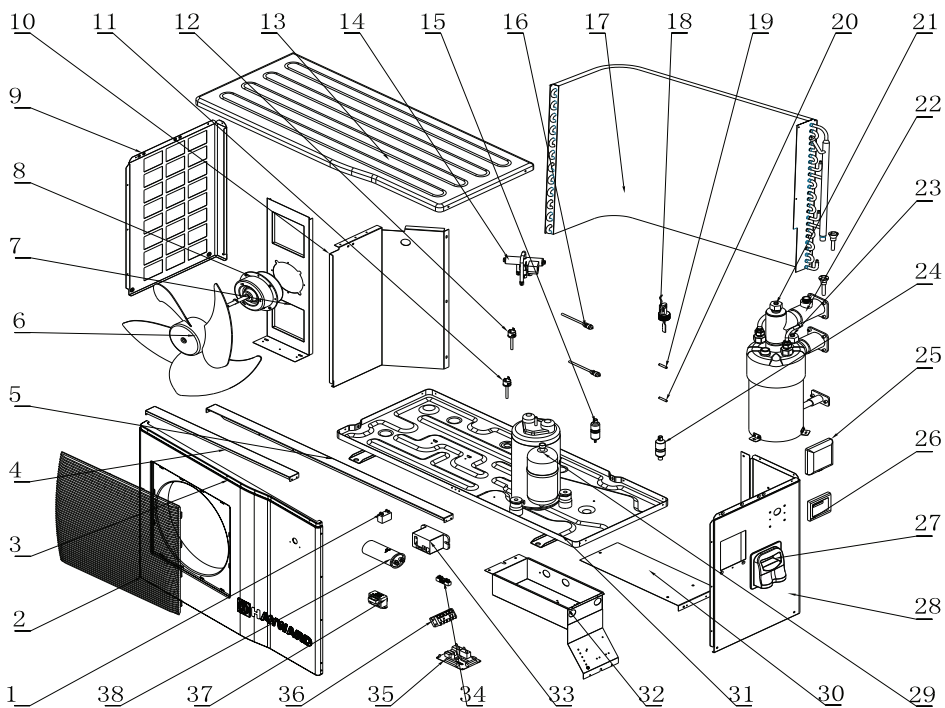

## 6. ANNEXES (suite)

### ECP 08

Rep	Réf.	Désignation	Rep	Réf.	Désignation
1	HWX20003501	Condensateur ventilateur 3 $\mu$ F	21	HWX20003242	Sonde de température
2	HWX35122213	Grille	22	HWX32081205	Condenseur Titane/PVC
3	HWX32012210240	Panneau ABS Avant	23	HWX20003242	Sonde de température
4	HWX321221175	Raidisseur Avant	24	HWX20041444	Filtre( $\Phi$ 9.7- $\Phi$ 9.7)
5	HWX321221018	Raidisseur Arrière	25	HWX20002111	Protection contrôleur
6	HWX35002701	Pale ventilateur	26	HWX950531188	Contrôleur 7 segments
7	HWX321221174	Support Moteur	27	HWX32009220054	Trappe d'accès électrique
8	HWX34043301	Moteur ventilateur	28	HWX32012210238	Panneau droit
9	HWX32012210239	Panneau gauche	29	HWX200011135	Compresseur
10	HWX321221173	Panneau de séparation	30	HWX321221019	Panneau protection électrique
11	HWX20013605	Pressostat Haute pression	31	HWX32012210237	Châssis
12	HWX20003603	Pressostat Basse pression	32	HWX321221176	Coffret électrique
13	HWX32012210241	Panneau ABS Supérieur	33	HWX20003619	Relais
14	HWX20011418	Vanne 4 voies	34	HWX20003909	Bornier 2 connexions
15	HWX20041446	Filtre ( $\Phi$ 9.7 - $\Phi$ 3.4)	35	HWX950531145	Carte Électronique PC1000
16	HWX200014153	Valve Shrader	36	HWX40003901	Bornier électrique 5 connexions
17	HWX34061204	Évaporateur	37	HWX200037006	Transformateur 230V~/12V~
18	HWX200036005	Détecteur de débit	38	HWX20003510	Condensateur compresseur 60 $\mu$ F
19	HWX20003242	Sonde de température	39	HWX20009909	Capillaire
20	HWX20003242	Sonde de température			

## 6. ANNEXES (suite)

---

### ECP 11

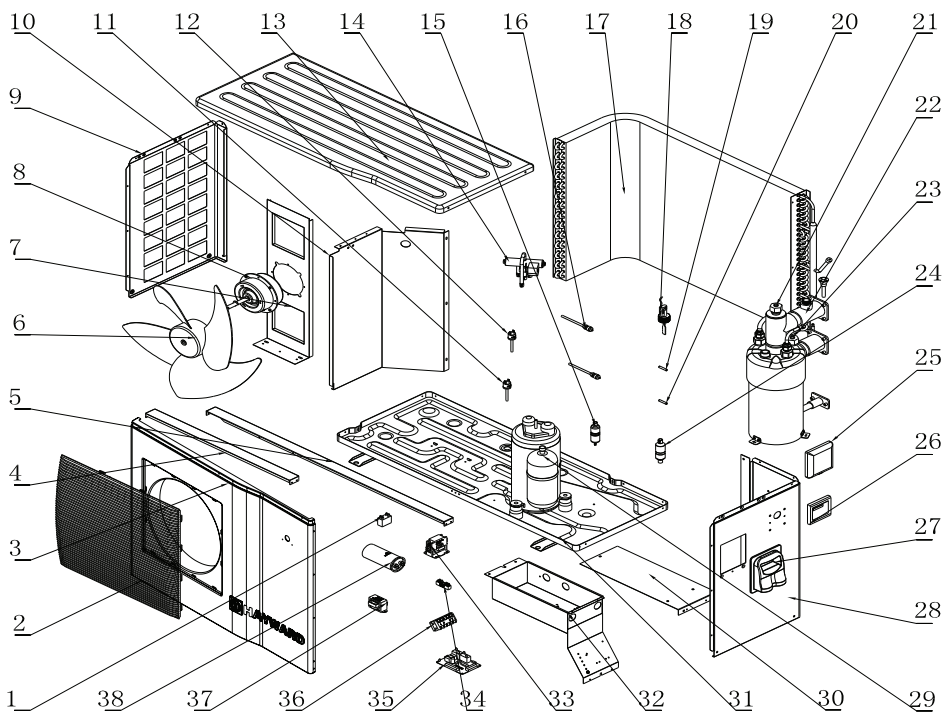

## 6. ANNEXES (suite)

### ECP 11

Rep	Réf.	Désignation	Rep	Réf.	Désignation
1	HWX20003501	Condensateur ventilateur 3 $\mu$ F	21	HWX20003242	Sonde de température
2	HWX35122213	Grille	22	HWX32121209	Condenseur Titane/PVC
3	HWX32012210240	Panneau ABS Avant	23	HWX20003242	Sonde de température
4	HWX321221175	Raidisseur Avant	24	HWX20041444	Filtre ( $\varnothing$ 9.7 - $\varnothing$ 9.7)
5	HWX321221018	Raidisseur Arrière	25	HWX20002111	Protection contrôleur
6	HWX35002701	Pale ventilateur	26	HWX950531188	Contrôleur 7 segments
7	HWX321221174	Support Moteur	27	HWX32009220054	Trappe d'accès électrique
8	HWX34043301	Moteur ventilateur	28	HWX32012210238	Panneau droit
9	HWX32012210239	Panneau gauche	29	HWX200011134	Compresseur
10	HWX321221173	Panneau de séparation	30	HWX321221019	Panneau protection électrique
11	HWX20013605	Pressostat Haute pression	31	HWX32012210237	Châssis
12	HWX20003603	Pressostat Basse pression	32	HWX321221176	Coffret électrique
13	HWX32012210241	Panneau ABS Supérieur	33	HWX200036006	Contacteur compresseur
14	HWX20011418	Vanne 4 voies	34	HWX20003909	Bornier 2 connexions
15	HWX20041446	Filter( $\varnothing$ 9.7- $\varnothing$ 3.4)	35	HWX950531145	Carte Électronique PC1000
16	HWX200014153	Valve Shrader	36	HWX40003901	Bornier électrique 5 connexions
17	HWX321212002	Évaporateur	37	HWX200037006	Transformateur 230V~/12V~
18	HWX200036005	Détecteur de débit	38	HWX20003505	Condensateur compresseur 50 $\mu$ F
19	HWX20003242	Sonde de température	39	HWX20009909	Capillaire
20	HWX20003242	Sonde de température			

## 6. ANNEXES (suite)

---

### ECP 13

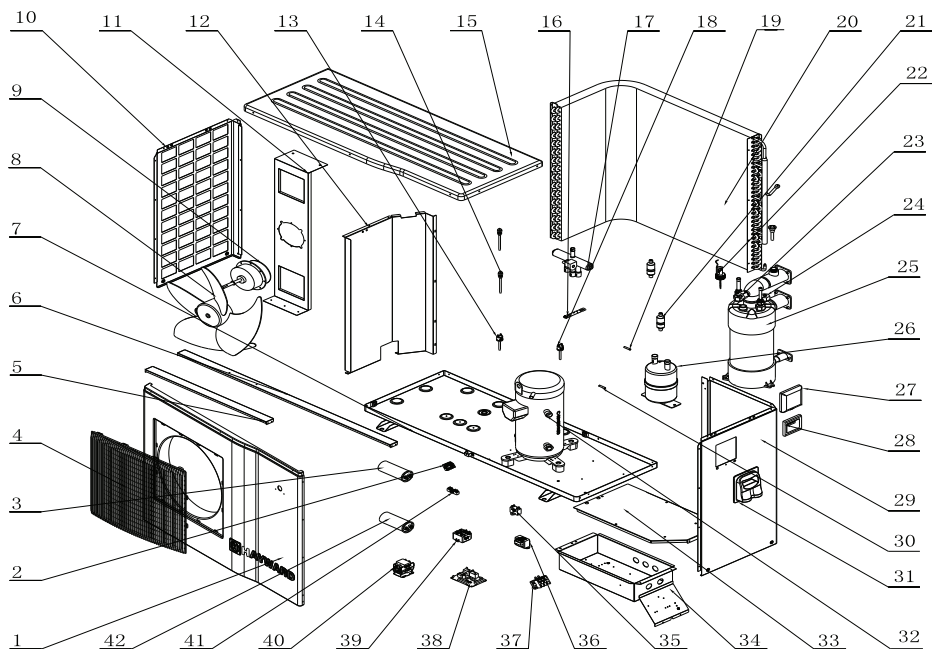



## 6. ANNEXES (suite)

### ECP 13

Rep	Réf.	Désignation	Rep	Réf.	Désignation
1	HWX32009210196	Panneau ABS Avant	23	HWX20003242	Sonde de température
2	HWX20003933	Bornier 3 connexions	24	HWX20003242	Sonde de température
3	HWX20003524	Condensateur démarrage CPS 98 $\mu$ F	25	HWX32091206	Condenseur Titane/PVC
4	HWX35122213	Grille	26	HWX35001401	Accumulateur
5	HWX320921015	Raidisseur Avant	27	HWX20002111	Protection contrôleur
6	HWX320921149	Raidisseur Arrière	28	HWX950531188	Contrôleur 7 segments
7	HWX32009210193	Châssis	29	HWX32009210194	Panneau droit
8	HWX35002701	Pale ventilateur	30	HWX20003242	Sonde de température
9	HWX34043301	Moteur ventilateur	31	HWX32009220054	Trappe d'accès électrique
10	HWX32009210195	Panneau gauche	32	HWX20011170	Compresseur
11	HWX320921147	Support Moteur	33	HWX320921152	Panneau protection électrique
12	HWX320921148	Panneau de séparation	34	HWX320921151	Coffret électrique
13	HWX20013605	Pressostat Haute pression	35	HWX20003501	Condensateur ventilateur 3 $\mu$ F
14	HWX200014153	Valve Shrader	36	HWX200037006	Transformateur 230V~/12V~
15	HWX32009210197	Panneau ABS Supérieur	37	HWX20003920	Bornier 3 connexions
16	HWX20001489	Restricteur	38	HWX950531145	Carte Électronique PC1000
17	HWX20011491	Vanne 4 voies	39	HWX20003676	Relais
18	HWX20003603	Pressostat Basse pression	40	HWX200036007	Contacteur compresseur
19	HWX20003242	Sonde de température	41	HWX20003909	Bornier 2 connexions
20	HWX351212001	Évaporateur	42	HWX20003510	Condensateur compresseur 60 $\mu$ F
21	HWX20041444	Filtre (Ø9.7-Ø9.7)	43	HWX20009909	Capillaire
22	HWX200036005	Détecteur de débit			

## 6. ANNEXES (suite)

---

### ECP 15

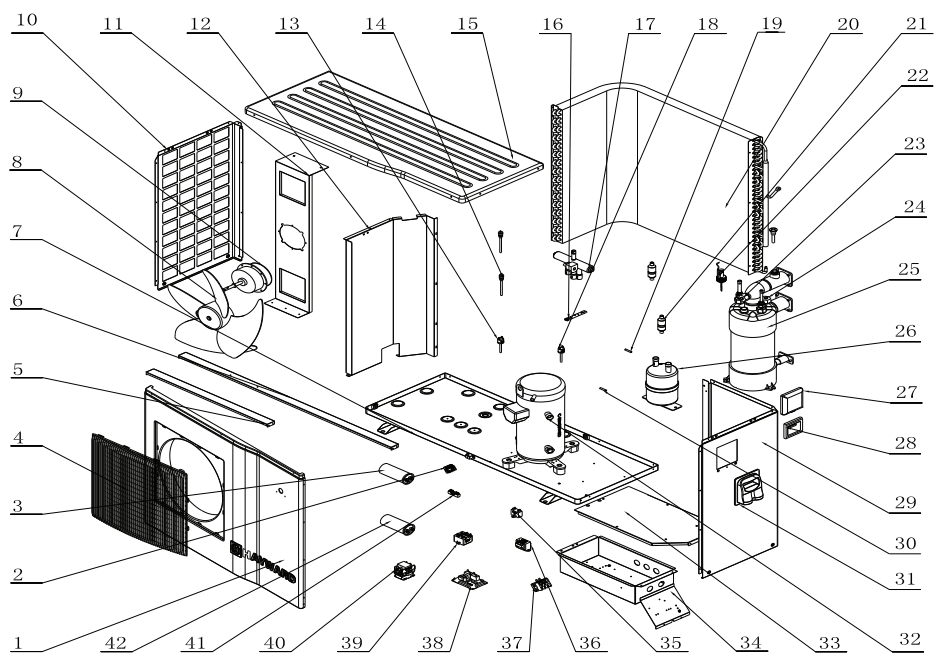

## 6. ANNEXES (suite)

### ECP 15

Rep	Réf.	Désignation	Rep	Réf.	Désignation
1	HWX32009210196	Panneau ABS Avant	23	HWX20003242	Sonde de température
2	HWX20003933	Bornier 3 connexions	24	HWX20003242	Sonde de température
3	HWX20003524	Condensateur démarrage CPS 98 $\mu$ F	25	HWX32091206	Condenseur Titane/PVC
4	HWX35122213	Grille	26	HWX35001401	Accumulateur
5	HWX320921015	Raidisseur Avant	27	HWX20002111	Protection contrôleur
6	HWX320921149	Raidisseur Arrière	28	HWX950531188	Contrôleur 7 segments
7	HWX32009210193	Châssis	29	HWX32009210194	Panneau droit
8	HWX35002701	Pale ventilateur	30	HWX20003242	Sonde de température
9	HWX34043301	Moteur ventilateur	31	HWX32009220054	Trappe d'accès électrique
10	HWX32009210195	Panneau gauche	32	HWX20011169	Compresseur
11	HWX320921147	Support Moteur	33	HWX320921152	Panneau protection électrique
12	HWX320921148	Panneau de séparation	34	HWX320921151	Coffret électrique
13	HWX20013605	Pressostat Haute pression	35	HWX20003501	Condensateur ventilateur 3 $\mu$ F
14	HWX200014153	Valve Shrader	36	HWX200037006	Transformateur 230V~/12V~
15	HWX32009210197	Panneau ABS Supérieur	37	HWX20003920	Bornier 3 connexions
16	HWX20001489	Restricteur	38	HWX950531145	Carte Électronique PC1000
17	HWX20011491	Vanne 4 voies	39	HWX20003676	Relais
18	HWX20003603	Pressostat Basse pression	40	HWX200036007	Contacteur compresseur
19	HWX20003242	Sonde de température	41	HWX20003909	Bornier 2 connexions
20	HWX351212001	Évaporateur	42	HWX20003510	Condensateur compresseur 60 $\mu$ F
21	HWX20041444	Filtre (Ø9.7-Ø9.7)	43	HWX20009909	Capillaire
22	HWX200036005	Détecteur de débit			

## 6. ANNEXES (suite)

### 6.4 Guide de dépannage



**Certaines opérations doivent être réalisées par un technicien habilité.**

Dysfonctionnement	Codes d'erreur	Description	Solution
Défaut sonde entrée d'eau	P01	Le capteur est ouvert ou présente un court-circuit.	Vérifier ou remplacer le capteur.
Défaut sonde sortie d'eau	P02	Le capteur est ouvert ou présente un court-circuit.	Vérifier ou remplacer le capteur.
Défaut sonde température extérieure	P04	Le capteur est ouvert ou présente un court-circuit.	Vérifier ou remplacer le capteur.
Défaut sonde de dégivrage	P05	Le capteur est ouvert ou présente un court-circuit.	Vérifier ou remplacer le capteur.
Protection haute pression	E01	Pression du circuit frigorifique trop élevée, ou débit d'eau trop faible, ou évaporateur obstrué, ou débit d'air trop faible.	Vérifier le pressostat haute pression et la pression du circuit frigorifique. Vérifier le débit d'eau ou d'air. Vérifier le bon fonctionnement du contrôleur de débit. Vérifier l'ouverture des vannes entrée/sortie d'eau. Vérifier le réglage du by-pass.
Protection basse pression	E02	Pression du circuit frigorifique trop faible, ou débit d'air trop faible ou évaporateur obstrué.	Vérifiez le pressostat basse pression et la pression du circuit frigorifique pour évaluer s'il existe une fuite. Nettoyer la surface de l'évaporateur. Vérifier la vitesse de rotation du ventilateur. Vérifier la libre circulation de l'air à travers l'évaporateur.
Défaut détecteur de débit	E03	Débit d'eau insuffisant ou détecteur en court circuit ou défectueux	Vérifiez le débit d'eau, vérifiez la pompe de filtration et le détecteur de débit pour voir s'ils présentent d'éventuels dysfonctionnements.
Différence de température trop grande entre l'eau en sortie et l'eau en entrée	E06	Débit d'eau en volume insuffisant, différence de pression d'eau trop faible / trop élevée.	Vérifier le débit d'eau, ou l'obstruction du système.
Protection Antigel Mode froid	E07	Quantité d'eau sortante trop faible.	Vérifier le débit d'eau, ou le capteur de température d'eau sortante.
Problème de communication	E08	Dysfonctionnement du contrôleur LED ou de la connexion PCB.	Vérifier la connexion des câbles.
Protection antigel de niveau 1	E19	Température ambiante, et de l'eau entrante trop faible.	Arrêter la pompe à chaleur et vidanger le condenseur. Risque de gel.
Protection antigel de niveau 2	E29	Température ambiante, et de l'eau entrante encore plus faible.	Arrêter la pompe à chaleur et vidanger le condenseur. Risque de gel.

## 6. ANNEXES (suite)

---

### 6.5 Garantie

#### CONDITIONS DE GARANTIE

Tous les produits HAYWARD sont garantis contre tous vices de fabrication ou de matière pendant une période de deux années à compter de la date d'achat. Toute demande de garantie devra être accompagnée d'une preuve d'achat justifiant sa date. Nous vous incitons donc à conserver votre facture.

La garantie HAYWARD est limitée à la réparation ou au remplacement, au choix d'HAYWARD, des produits défectueux pour autant qu'ils aient subi un emploi normal, en accord avec les prescriptions mentionnées dans leur manuel d'utilisation, que le produit n'ait été modifié d'aucune sorte et utilisé uniquement avec des composants et des pièces HAYWARD. Les dommages dûs au gel et aux attaques d'agents chimiques ne sont pas garantis.

Tous les autres frais (transport, main d'œuvre...) sont exclus de la garantie.

HAYWARD ne pourra être tenu pour responsable d'aucun dommage direct ou indirect provenant de l'installation, du raccordement ou du fonctionnement incorrect d'un produit.

Pour faire jouer une garantie et demander la réparation ou le remplacement d'un article, adressez vous à votre revendeur. Aucun retour de matériel à notre usine ne sera accepté sans notre accord écrit préalable.

Les pièces d'usure ne sont pas couvertes par la garantie.

# EASY TEMP

## SWIMMING POOL HEAT PUMP UNIT

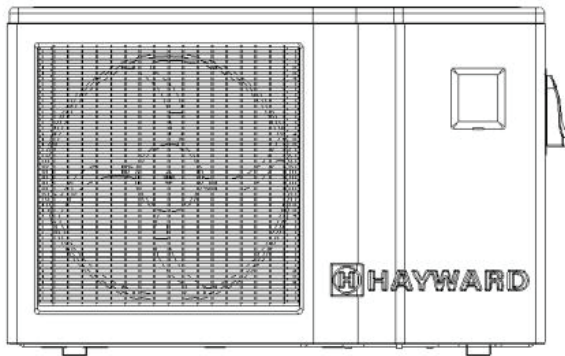

### Installation & Instruction Manual

# CONTENTS

---

<b>1. Preface</b>	<b>1</b>
<hr/>	
<b>2. Technical specifications</b>	<b>2</b>
2.1 Technical data for the swimming pool heat pump unit	2
2.2 Operating range	3
2.3 Dimensions	4
<hr/>	
<b>3. Installation and connection</b>	<b>5</b>
3.1 Functional diagram	5
3.2 Heat pump unit	5
3.3 Hydraulic connection	6
3.4 Electrical connection	7
3.5 Initial start-up	8
3.6 Water flow setting	10
<hr/>	
<b>4. User interface</b>	<b>11</b>
4.1 Overview	11
4.2 Setting the clock	13
4.3 Setting the Timer function	13
4.4 Choice of operating mode: heating or cooling	14
4.5 Settings and viewing the set point	15
4.6 Locking and unlocking the user interface	15
<hr/>	
<b>5. Maintenance and winterisation</b>	<b>16</b>
5.1 Maintenance	16
5.2 Winterisation	16
<hr/>	
<b>6. Appendices</b>	<b>17</b>
6.1 Wiring Diagrams	17
6.2 Heating priority connections	22
6.3 Exploded views and spare parts	23
6.4 Troubleshooting guide	33
6.5 Warranty	34

Read carefully and keep for later consultation.

This document must be given to the owner of the swimming pool, who must keep it in a safe place.

# 1. PREFACE

---

Thank you for purchasing this Easy Temp swimming pool heat pump unit. This product has been designed in compliance with strict manufacturing standards to meet the required quality levels. This manual includes all the information you need for installing, troubleshooting and maintenance. Read this manual carefully before opening the unit or performing any maintenance operations. The manufacturer of this product will in no way be held liable for any injuries to a user or damage to the unit resulting from incorrect installation, troubleshooting and repairs or poor maintenance. It is essential to follow the instructions given in this manual at all times. The unit must be installed by a qualified engineer.

- Repairs must be performed by a qualified engineer.
- All electrical connections must be made by a qualified professional electrician and in compliance with the standards applied in the country in which it is installed. See Section 3.4.
- Maintenance and its various operations must be carried out at the recommended frequency and times, as specified in this manual.
- Only use original spare parts.
- Failure to comply with these recommendations will invalidate the warranty.
- This swimming pool heat pump unit heats swimming pool water and maintains a constant temperature. It is not to be used for any other purpose.

Once you have read the manual, keep for later use.

Warnings concerning children/people of restricted physical ability:

This appliance is not designed to be used by people (particularly children) of limited physical, sensory or mental ability, or by people who lack experience or knowledge, unless they are under supervision or have received instruction as to how to use the appliance from a person responsible for their safety.

This product contains fluorinated greenhouse gasses covered by the Kyoto protocol.

Type of refrigerant: R410A

GWP value<sup>(1)</sup>: 1975

Periodic inspections for refrigerant leaks may be required depending on local or European legislation. Please contact your local distributor for more information.

---

(1) Global warming potential



## 2. TECHNICAL SPECIFICATIONS

### 2.1 Technical data for the swimming pool heat pump unit

Model	EASY TEMP	ECP 06	ECP 08	ECP 11	ECP 13	ECP 15
Heating capacity*	kW BTU/h	5.5 18785	8 27322	11 37566	13.5 46105	15 51228
Electrical power rating	kW	1.17	1.8	2.43	3	3.13
Operating current*	A	5.19	7,91	11,81	14,5	16
Electrical connection	V Ph/Hz	230 V~ 1 / 50Hz	230 V~ 1 / 50Hz	230 V~ 1 / 50Hz	230 V~ 1 / 50Hz	230 V~ 1 / 50Hz
Fuse rating aM	A	8 aM	10 aM	16 aM	20 aM	20 aM
D-curve circuit breaker	A	8 D	10 D	16 D	20 D	20 D
Number of compressors		1	1	1	1	1
Type of compressor		Rotary	Rotary	Rotary	Scroll	Scroll
Number of fans		1	1	1	1	1
Fan power	W	50	120	120	120	120
Fan rotation speed	RPM	770	850	850	850	850
Fan direction		Horizontal	Horizontal	Horizontal	Horizontal	Horizontal
Sound pressure level (at 1 metre)	dB(A)	47	51	54	56	56
Hydraulic connection	mm	50	50	50	50	50
Water flow rate	m <sup>3</sup> /h	2.3	3.0	4.5	5.3	6.6
Water pressure drop (max)	kPa	5.4	8.9	19.2	5.2	39.9
Unit net dimensions (L/W/H)	mm	895/375/545	1035/415/650	1035/415/650	1136/440/870	1136/440/870
Unit shipping dimensions (L/W/H)	mm	970/430/710	1120/480/810	1180/480/810	1230/510/1020	1230/510/1020
Unit net weight/shipping weight	kg	45/56	54/68	60/74	95/115	117/128



\* Value +/- 5% in the following conditions: Outside temperature = 24°C (75°F)/RH=62%/Pool temperature=27°C (80°F)

## 2. TECHNICAL SPECIFICATIONS (continued)

---

### 2.2 Operating range

Use the heat pump within the following temperatures and humidity ranges to ensure safe and efficient operation.

	Heating mode 	Cooling mode 
Outside temperature	+2°C ~ +35°C	+7°C ~ +43°C
Water temperature	+12°C ~ +40°C	+8°C ~ +40°C
Relative humidity	< 80%	< 80%
Set point setting range	+15°C ~ +40°C	+8°C ~ +35°C



***If the temperature or humidity do not fall within these conditions, safety devices may be triggered and the heat pump may no longer work.***

## 2. TECHNICAL SPECIFICATIONS (continued)

### 2.3 Dimensions

Models: ECP 06 / ECP 08 / ECP 11 / ECP 13 / ECP 15

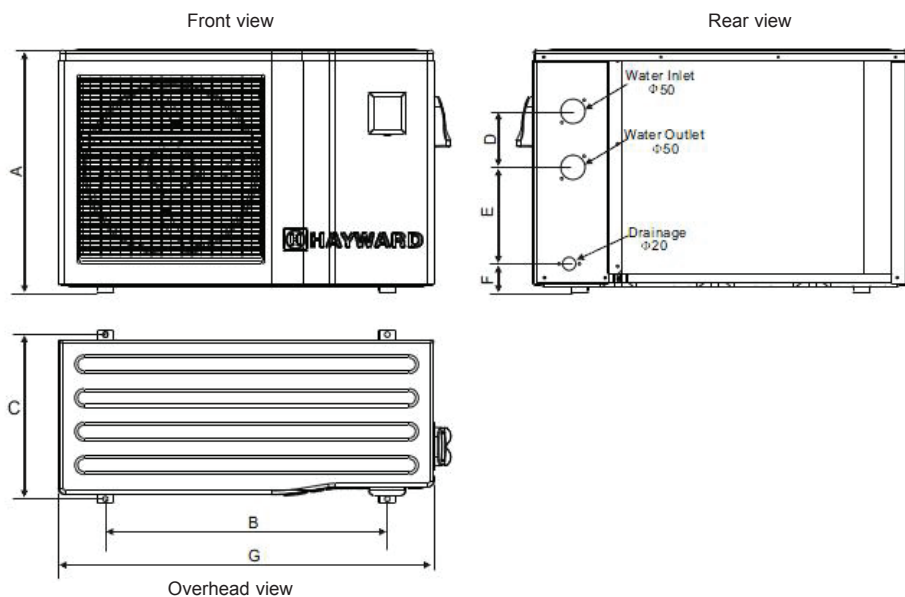

Unité : mm

Modèle Repère	ECP06	ECP08 ECP11	ECP13 ECP15
<b>A</b>	540	648	866
<b>B</b>	571	755	840
<b>C</b>	400	440	470
<b>D</b>	140	150	150
<b>E</b>	258	258	330
<b>F</b>	66	77	80
<b>G</b>	860	1004	1114

# 3. INSTALLATION AND CONNECTION

## 3.1 Functional Diagram

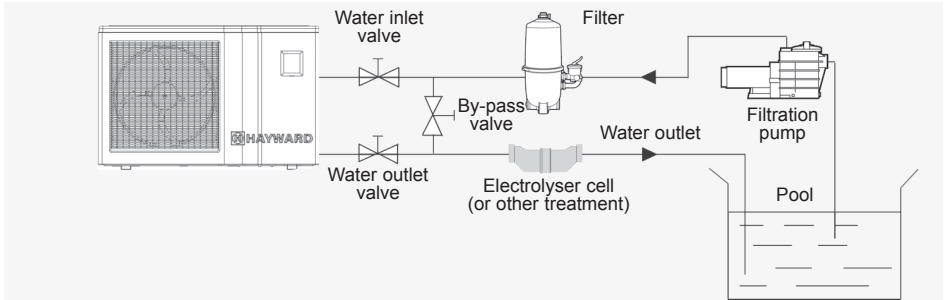

Note: The swimming pool heat pump unit is sold without any treatment or filtration equipment. The components shown on the diagram are parts to be supplied by the installation engineer.

## 3.2 Heat pump



***Place the heat pump outside and away from any enclosed plant room.***

***Placed under a shelter, the minimum distances given below must be respected to avoid any risk of air recirculation and deterioration in the heat pump's overall performance.***

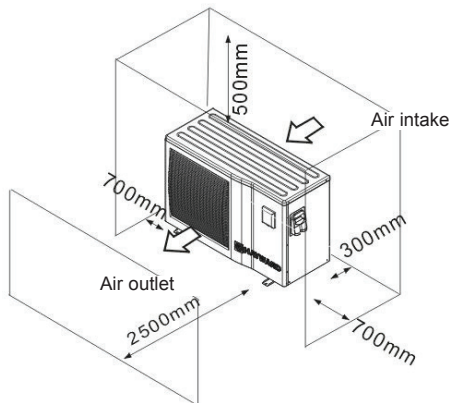

### 3. INSTALLATION AND CONNECTION (continued)

---



*It is advisable to install the heat pump on a separate concrete block or on a mounting bracket designed for this purpose and to mount the heat pump on the supplied rubber bushing (fastenings and washers not supplied).*

*The maximum installation distance between the heat pump and the swimming pool is 15 metres.*

*The total length of the hydraulic pipes to and from the unit is 30 metres.*

*Insulate both surface and buried hydraulic pipes.*

#### 3.3 Hydraulic connection

The heat pump is supplied with two 50 mm diameter union connections. Use PVC tubing for the 50 mm hydraulic line. Connect the heat pump water inlet to the pipe from the filtration unit then connect the heat pump water outlet to the water pipe going to the pool (see diagram below).

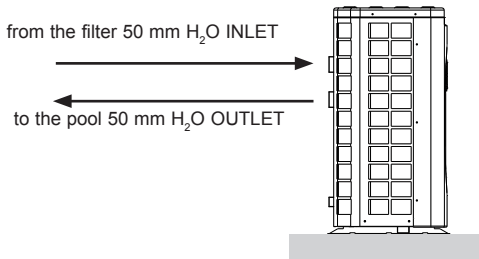

Install by-pass valve between the inlet and outlet on the heat pump.



*If an automatic distributor or an electrolyser is used, it must be installed after the heat pump to protect the titanium capacitor from high concentrations of chemical products.*



*Make sure you install the by-pass valve and union connections supplied to the unit's water inlet and outlet so as to simplify purging over the winter period, to facilitate access or dismantling for maintenance.*

### 3. INSTALLATION AND CONNECTION (continued)

#### 3.4 Electrical Connection



**The electrical installation and wiring of this equipment must comply with local installation standards.**

F	NF C15-100	GB	BS7671:1992
D	DIN VDE 0100-702	EW	EVHS-HD 384-7-702
A	ÖVE 8001-4-702	H	MSZ 2364-702/1994/MSZ 10-553 1/1990
E	UNE 20460-7-702 1993, RECBT ITC-BT-31 2002	M	MSA HD 384-7-702.S2
IRL	Wiring Rules + IS HD 384-7-702	PL	PN-IEC 60364-7-702:1999
I	CEI 64-8/7	CZ	CSN 33 2000 7-702
LUX	384-7.702 S2	SK	STN 33 2000-7-702
NL	NEN 1010-7-702	SLO	SIST HD 384-7-702.S2
P	RSIUEE	TR	TS IEC 60364-7-702



**Check that the available electrical power supply and the network frequency correspond to the required operating current, taking into account the appliance's specific location and the current needed to power any other appliance connected to the same circuit.**

**ECP 06 230 V~ +/- 10 % 50 Hz 1 Phase**

**ECP 08 230 V~ +/- 10 % 50 Hz 1 Phase**

**ECP 11 230 V~ +/- 10 % 50 Hz 1 Phase**

**ECP 13 230 V~ +/- 10 % 50 Hz 1 Phase**

**ECP 15 230 V~ +/- 10 % 50 Hz 1 Phase**

**See the corresponding wiring diagram in the appendix.**

**The connection box is located on the right side of the unit. Three of the connections are for the power supply and two are for the filtration pump control (Servo control).**

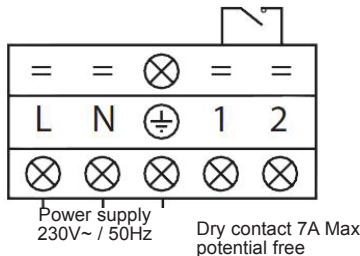

## 3. INSTALLATION AND CONNECTION (continued)

---



*The electrical power supply must have a motor power supply (aM) or D-curve circuit breaker fuse protection device, as appropriate, and a 30mA earth-leak circuit breaker (see table below).*

Models		ECP 06	ECP 08	ECP 11	ECP 13	ECP 15
Electrical connection	V/Ph/ Hz	230 V~ 1/50 Hz	230 V~ 1/50 Hz	230 V~ 1/50 Hz	230 V~ 1/50 Hz	230 V~ 1/50 Hz
Fuse rating aM	A	8 aM	10 aM	16 aM	20 aM	20 aM
D-curve circuit breaker	A	8 D	10 D	16 D	20 D	20 D



*Always turn off the mains power supply before opening the electrical control box.*

### 3.5 Initial start-up

Start-up procedure – once installed, perform the following steps:

- 1) Turn the fan by hand to check that it turns freely, and that the blades are properly attached to the motor shaft.
- 2) Check that the unit is correctly connected to the main power supply (see wiring diagram in the appendix).
- 3) Turn on the filtration pump.
- 4) Check that all the water valves are open, and that the water flows towards the unit before switching on the heating or cooling mode.
- 5) Check that the condensate drainage hose is attached correctly and does not cause an obstruction.
- 6) Turn on the unit's power supply, then press the On/Off button  on the control panel.

### 3. INSTALLATION AND CONNECTION (continued)

---

- 7) Check that no ALARM code is displayed when the unit is ON (see troubleshooting guide).
- 8) Set the water flow rate using the by-pass valve (see Sections 3.6 and 2.1), as provided for on each model, to obtain a Entry/Exit temperature difference of 2°C.
- 9) After running for a few minutes, check that the air exiting the unit is cool (between 5 and 10°C).
- 10) With the unit operating, turn off the filter pump. The unit should turn off automatically and display error code E03.
- 11) Run the unit and pool pump 24 hours a day until the desired water temperature has been reached. When the set water inlet temperature is reached, the unit will shut down. It will restart automatically (provided the pool pump is running) if the pool temperature falls by 0.5°C below the set temperature.

**Flow rate controller** - The unit is fitted with a flow rate controller that turns on the heat pump when the pool filtration pump is running and turns it off if the filtration pump is off. If the water is low, alarm code E03 is displayed on the regulator (See Section 6.4).

**Time delay** - the unit incorporates a time delay of 3 minutes to protect the control circuit components, eliminate any restart instability and any switch mechanism interference. Thanks to this time delay, the unit restarts automatically approximately 3 minutes after any loss of power to the control circuit. Even a brief loss of power activates the restart time delay.



# 3. INSTALLATION AND CONNECTION (continued)

## 3.6 Water flow setting

While the heat pump is running and the water inlet and outlet valves are open, adjust the by-pass valve to obtain a difference of 2°C between the water inflow and outflow temperature (see Functional Diagram Section 3.1). You can check the setting by viewing the inflow (T02)/outflow (T03) temperatures directly on the control panel by following the procedure below.

Then adjust the by-pass to obtain a difference of 2°C between T03 and T02

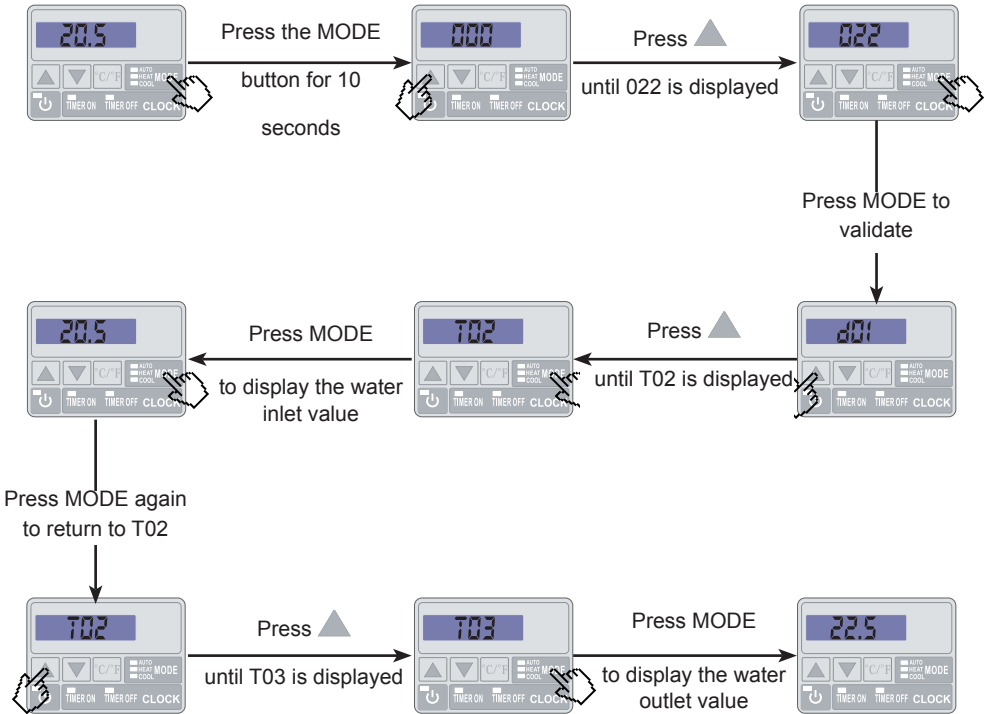

(T03-T02 =  $\Delta T$  = 2).

Press  twice to exit the menu

Note: Opening the by-pass valve creates a weaker flow which results in an increased  $\Delta T$ .

Closing the by-pass valve creates a stronger flow which results in a decreased  $\Delta T$ .

## 4. USER INTERFACE







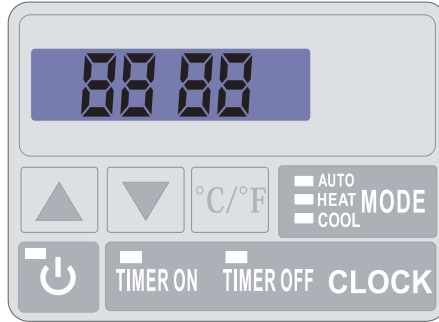



---

### 4.1 Overview

The heat pump is fitted with an electronic control panel, electronically connected and pre-set at the factory to heating mode.



#### Key

-  **COOL** Cooling Mode symbol
-  **HEAT** Heating Mode symbol
-  **AUTO** Automatic mode
-  **CLOCK** Clock and Timer settings
-  **MODE** Selection and settings button
-  **Power** On/Off and Return/Validation button
-  **Scroll down** Scroll down
-  **Scroll up** Scroll up
-  **TIMER ON** On time setting
-  **TIMER OFF** Off time setting

## 4. USER INTERFACE (continued)

---

### OFF Mode

When the heat pump is on standby(OFF Mode), the time and operating mode are displayed on the control screen.

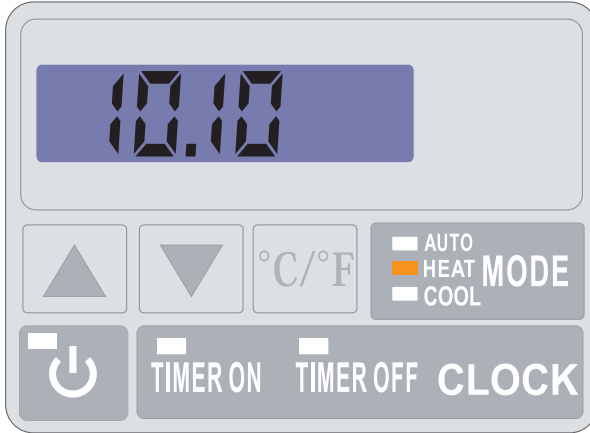

### ON Mode



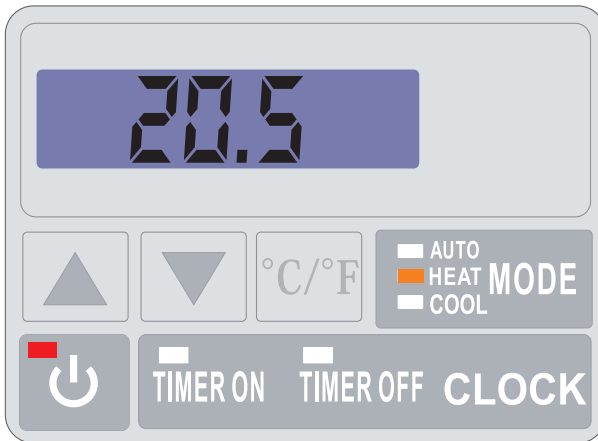

When the heat pump is running or adjusting (ON Mode), the red light on the ON button is lit and the water inlet temperature is displayed on the screen.



## 4. USER INTERFACE (continued)

---

### 4.2 Setting the clock





The clock can be set in ON or OFF mode. Press CLOCK once and the display flashes then press CLOCK again and the hours flash. Set the hour using the arrows  or  then press CLOCK again to select minutes. Set the minutes using the arrows  or . Press CLOCK again to confirm. The display returns to its previous status.

Note: Settings are saved by pressing the CLOCK button or are saved automatically if no button is pressed after 5 seconds.

### 4.3 Setting the Timer function

This function needs to be set if you want to run your heat pump for a shorter period than the one set by the filtration clock. You can therefore programme a delayed start and an early shutdown or simply stop a particular period from running (e.g. the night).





#### Start Programme (Timer ON) / Start

- 1) Press Timer ON, the hour flashes.
- 2) Press Timer ON to set the hour using the buttons  .
- 3) Press Timer ON to set the minutes using the buttons  .

Settings are saved by pressing the Timer ON button or are saved automatically if no button is pressed after 5 seconds.

A green light indicates that the timer is on.

#### Stop programme (Timer OFF)/Stop

- 1) Press Timer OFF, the hour flashes.
- 2) Press Timer OFF to set the hour using the buttons  .
- 3) Press Timer OFF to set the minutes using the buttons  .



Settings are saved by pressing the Timer OFF button or are saved automatically if no button is pressed after 5 seconds.

A red light indicates that the timer is on.

## 4. USER INTERFACE (continued)

---

### Turning off Timer settings (ON and OFF Timer)/Off and On

- 1) Press Timer ON, Timer ON flashes.
- 2) Press  to delete the programme.
- 3) Press Timer OFF, Timer OFF flashes.
- 4) Press  to delete the programme.

### 4.4 Choice of operating mode: heating, cooling or automatic.

#### In “OFF” or “ON” Mode

Press the MODE button to switch between cooling mode (green light), heating mode (orange light) and automatic mode (red light).

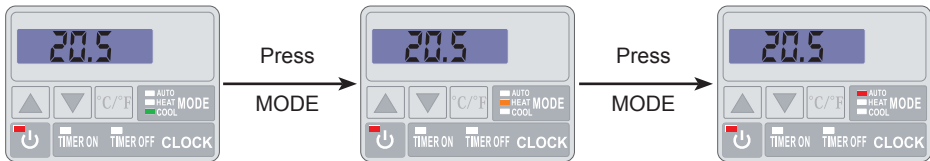



## 4. USER INTERFACE (continued)

---



### 4.5 Settings and viewing the set point (Desired water temperature)

#### In “OFF” and “ON” Mode

Press the buttons  or  to set the desired set point. Settings are made to an accuracy of 0.5 °C.



*It is recommended never to exceed 30°C to avoid deterioration of the liners.*

Note: Whether on or off, all you need to do is press the  or  button to view or change the set point.

### 4.6 Locking and unlocking the touch screen

Press the On/Off  button for 5 seconds until it beeps. The buttons become inactive.

To unlock, press  for 5 seconds until it beeps.

The buttons become active again.

## 5. MAINTENANCE AND WINTERISATION

---

### 5.1 Maintenance

These maintenance operations must be carried out once a year to guarantee the heat pump's life-span and serviceability.

- Clean the coil using a soft brush or a water or air jet (**Warning, never use a high pressure cleaner**).
- Check that the condensate drains are working well.
- Check that the hydraulic and electrical connections are secure
- Check the coil's hydraulic seal.



***The heat pump must be disconnected from any electrical power source before any maintenance operation can be carried out. Maintenance operations must only be carried out by a qualified engineer, authorised to handle refrigerants.***

### 5.2 Winterisation

- Switch the heat pump to “OFF” Mode.
- Turn off the power supply to the heat pump.
- Drain the coil to avoid any risk of deterioration. (High risk of freezing).
- Close the by-pass valve and unscrew the inlet/outlet union connections.
- Drain as much of the residual stagnant water as possible from the coil using a blow gun.
- Close the water inlet and outlet on the heat pump to stop foreign bodies entering.
- Cover the heat pump with a winter cover (not supplied).



***Any damage caused by poor winterisation invalidates the warranty.***

# 6. APPENDICES

## 6.1 Wiring diagrams

ECP 06

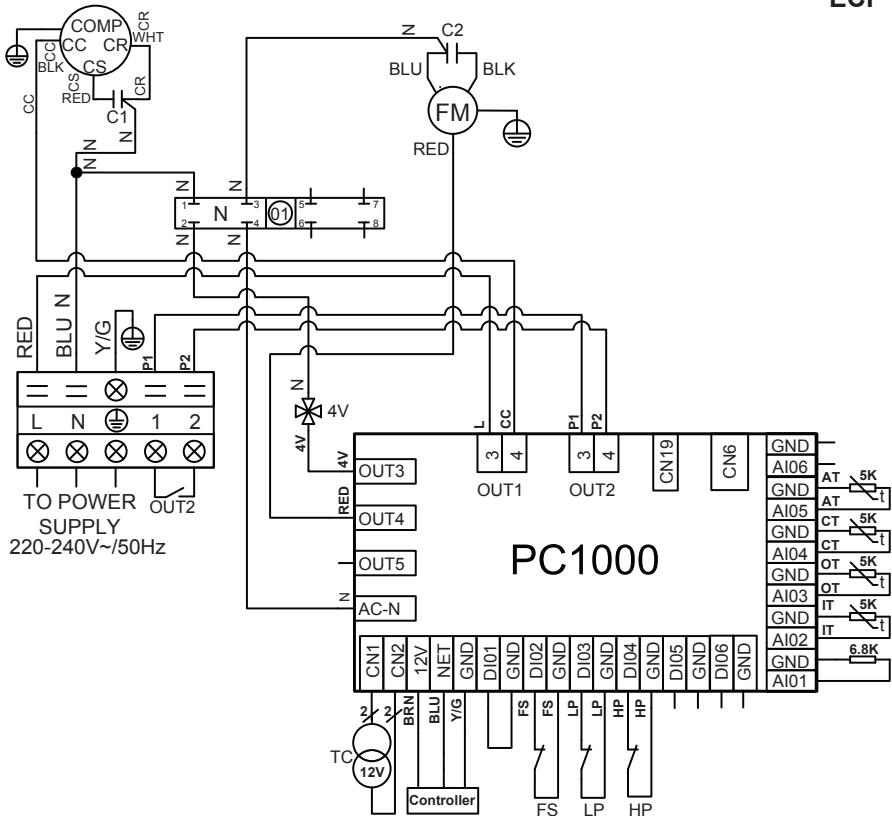

**COMMENT:**

- AT: AIR TEMPERATURE SENSOR
- COMP: COMPRESSOR
- CT: EVAPORATOR TEMPERATURE SENSOR
- FM: FAN MOTOR
- FS: WATER DETECTOR
- HP: HIGH-PRESSURE SWITCH
- IT: WATER INLET TEMPERATURE SENSOR

- LP: LOW-PRESSURE SWITCH
- OT: WATER OUTLET TEMPERATURE SENSOR
- TC : 230V~/ 12V~ TRANSFORMER
- 4V: 4-WAY VALVE
- C1: COMPRESSOR CAPACITOR
- C2: FAN CAPACITOR
- OUT2 : DRY CONTACT 7 A MAX



# 6. APPENDICES (continued)

ECP 08

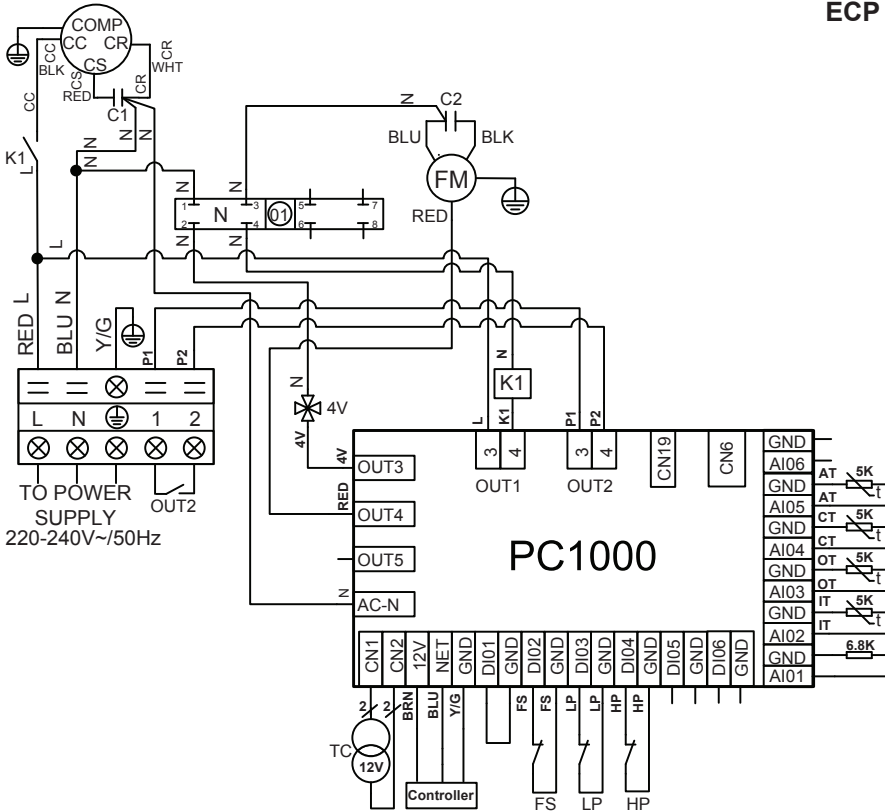

**COMMENT:**

- AT: AIR TEMPERATURE SENSOR
- COMP: COMPRESSOR
- CT: EVAPORATOR TEMPERATURE SENSOR
- FM: FAN MOTOR
- FS: WATER DETECTOR
- HP: HIGH-PRESSURE SWITCH
- IT: WATER INLET TEMPERATURE SENSOR

- LP: LOW-PRESSURE SWITCH
- OT: WATER OUTLET TEMPERATURE SENSOR
- TC : 230V~/ 12V~ TRANSFORMER
- 4V: 4-WAY VALVE
- K1: COMPRESSOR RELAY
- C1: COMPRESSOR CAPACITOR
- C2: FAN CAPACITOR
- OUT2 : DRY CONTACT 7 A MAX

# 6. APPENDICES (continued)

ECP 11

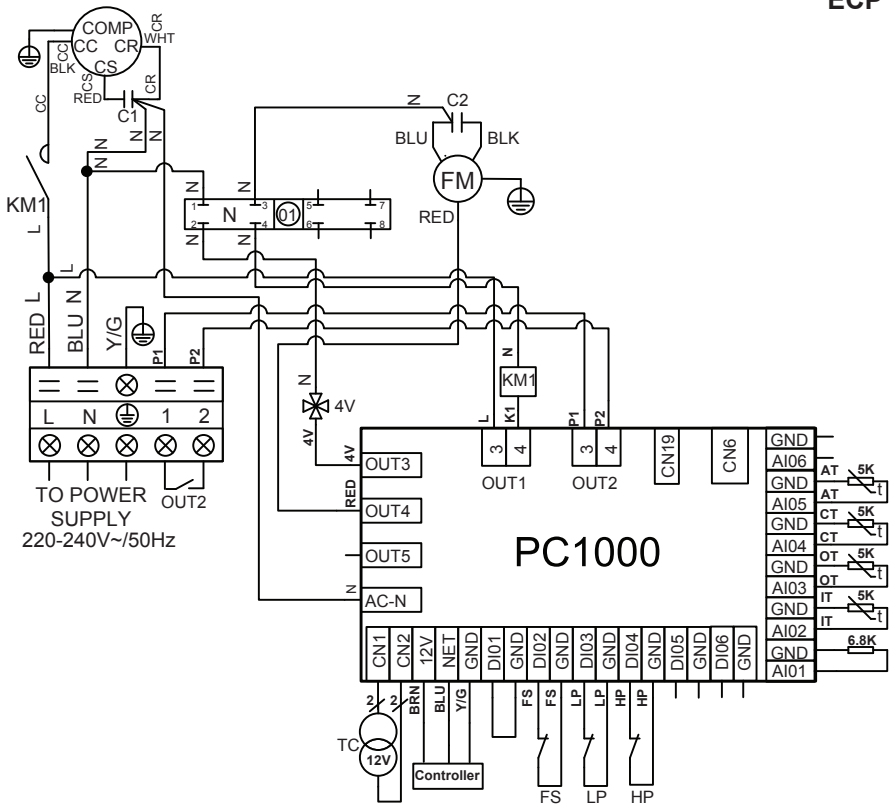

**COMMENT:**

- AT: AIR TEMPERATURE SENSOR
- COMP: COMPRESSOR
- CT: EVAPORATOR TEMPERATURE SENSOR
- FM: FAN MOTOR
- FS: WATER DETECTOR
- HP: HIGH-PRESSURE SWITCH
- IT: WATER INLET TEMPERATURE SENSOR

- LP: LOW-PRESSURE SWITCH
- OT: WATER OUTLET TEMPERATURE SENSOR
- TC : 230V~/ 12V~ TRANSFORMER
- 4V: 4-WAY VALVE
- KM1: COMPRESSOR POWER CONTACT
- C1: COMPRESSOR CAPACITOR
- C2: FAN CAPACITOR
- OUT2 : DRY CONTACT 7 A MAX

# 6. APPENDICES (continued)

ECP 13

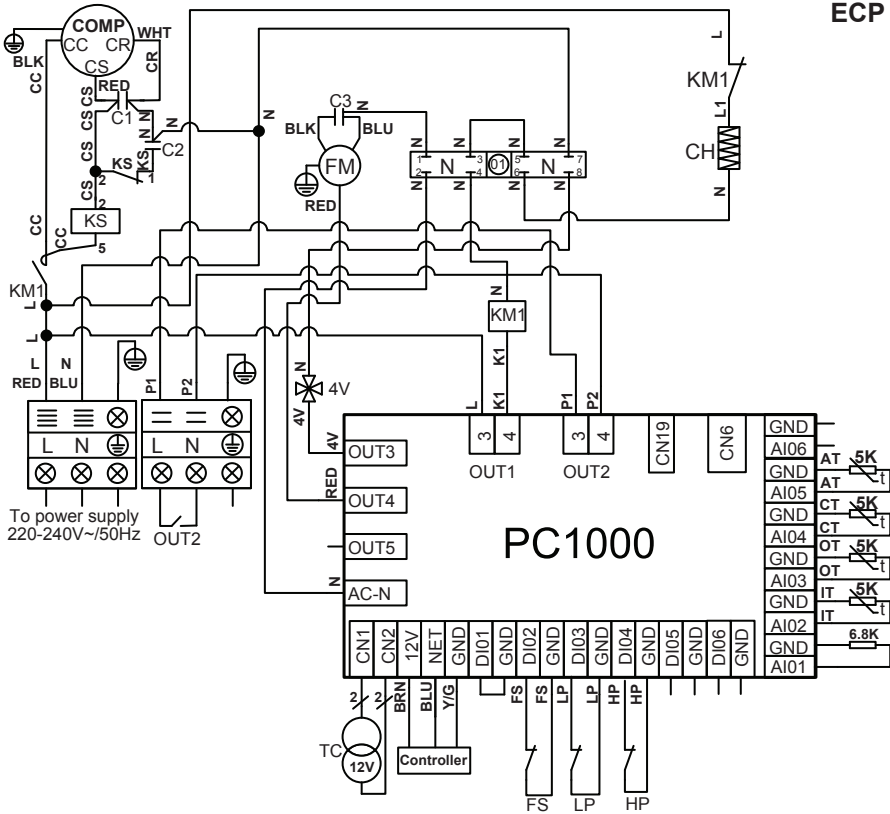

**COMMENT:**

- AT: AIR TEMPERATURE SENSOR
- COMP: COMPRESSOR
- CH: SUMP HEATER
- CT: EVAPORATOR TEMPERATURE SENSOR
- FM: FAN MOTOR
- FS: WATER DETECTOR
- HP: HIGH-PRESSURE SWITCH
- IT: WATER INLET TEMPERATURE SENSOR

- KS: COMPRESSOR START RELAY COIL
- LP: LOW-PRESSURE SWITCH
- OT: WATER OUTLET TEMPERATURE SENSOR
- TC : 230V~ / 12V~ TRANSFORMER
- 4V: 4-WAY VALVE
- KM1: COMPRESSOR POWER CONTACT
- C1: PERMANENT CAPACITOR
- C2: START CAPACITOR
- OUT2 : DRY CONTACT 7 A MAX

# 6. APPENDICES (continued)

ECP 15

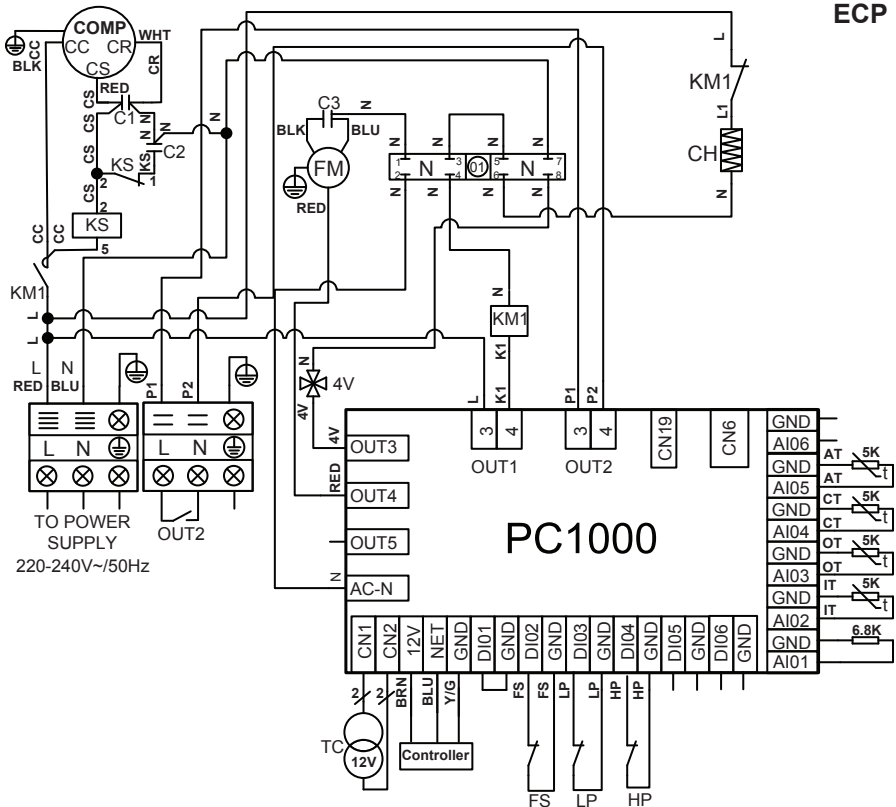

**COMMENT:**

- AT: AIR TEMPERATURE SENSOR
- COMP: COMPRESSOR
- CH: SUMP HEATER
- CT: EVAPORATOR TEMPERATURE SENSOR
- FM: FAN MOTOR
- FS: WATER DETECTOR
- HP: HIGH-PRESSURE SWITCH
- IT: WATER INLET TEMPERATURE SENSOR

- KS: COMPRESSOR START RELAY COIL
- LP: LOW-PRESSURE SWITCH
- OT: WATER OUTLET TEMPERATURE SENSOR
- TC : 230V~/ 12V~ TRANSFORMER
- 4V: 4-WAY VALVE
- KM1: COMPRESSOR POWER CONTACT
- C1: PERMANENT CAPACITOR
- C2: START CAPACITOR
- OUT2 : DRY CONTACT 7 A MAX

## 6. APPENDICES (continued)

### 6.2 Heating priority connections Single-Phase Pump

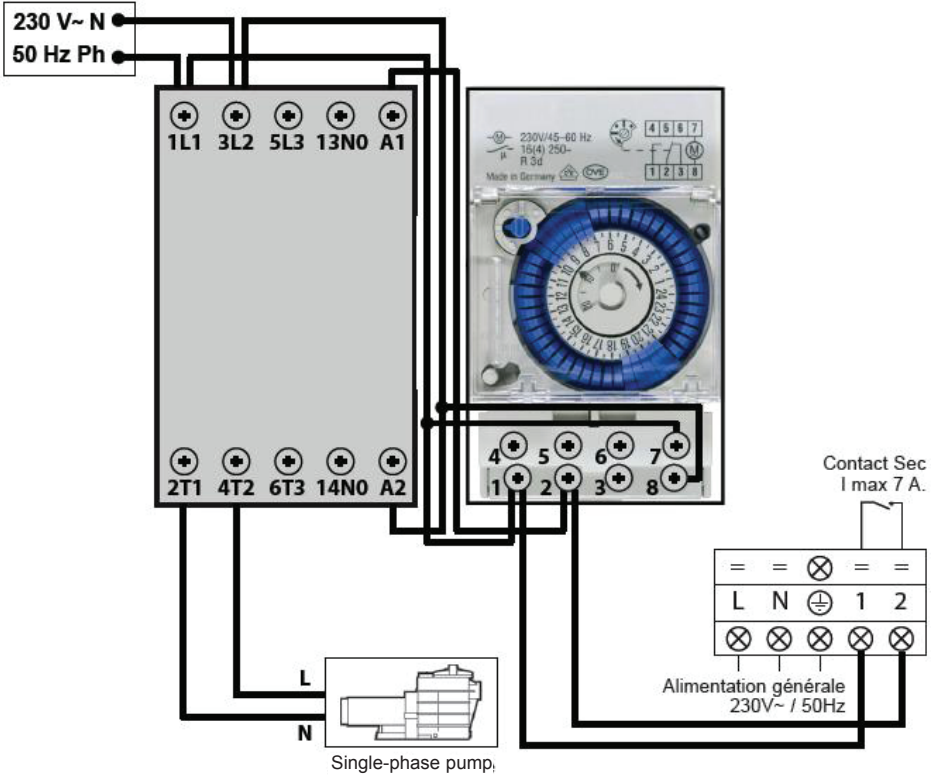

Terminals 1 and 2 deliver a potential-free dry contact, 230 V~ / 50 Hz, no polarity.

Wire terminals 1 and 2 as indicated in the diagram above, to activate the operation of the filtration pump in 2-minute cycles each hour if the temperature of the pool is lower than the set point.

 Never connect the power supply of the filtration pump directly to terminals 1 and 2.



# 6. APPENDICES (continued)

## 6.3 Exploded view and spare parts

ECP 06

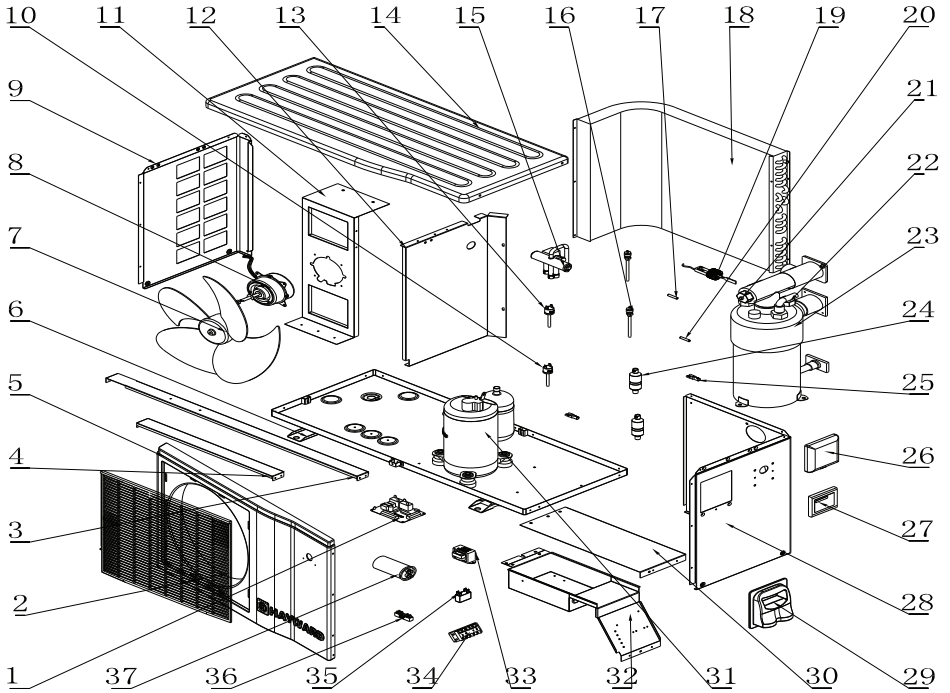

## 6. APPENDICES (continued)

---

### ECP 06

N	Ref.	Description	N	Ref.	Description
1	HWX950531145	PC1000 circuit board	20	HWX20003242	Temperature sensor
2	HWX35252208	Grille	21	HWX20003242	Temperature sensor
3	HWX322521062	Rear stiffener	22	HWX20003242	Temperature sensor
4	HWX322521063	Front stiffener	23	HWX35251210	Titanium/PVC capacitor
5	HWX32025210084	Front ABS panel	24	HWX20041444	Filter (diam. 9.7- diam. 9.7)
6	HWX32025210081	Frame	25	HWX200014068	Capillary connector
7	HWX34012701	Fan blade	26	HWX20002111	Controller protective cover
8	HWX34013301	Fan motor	27	HWX950531188	7-segment controller
9	HWX32025210083	Left panel	28	HWX322521057	Right panel
10	HWX20003603	Low pressure switch	29	HWX32009220054	Protection cover
11	HWX322521061	Motor bracket	30	HWX322521064	Electrical box cover
12	HWX322521059	Centre wall	31	HWX200011006	Compressor
13	HWX20013605	High pressure switch	32	HWX322521006	Electrical box
14	HWX322522016	Top ABS cover	33	HWX200037006	230V~/12V~ transformer
15	HWX20011418	4-way valve	34	HWX40003901	5-point terminal block
16	HWX200014153	Schröder valve	35	HWX20003506	Fan capacitor 2 $\mu$ F
17	HWX20003242	Temperature sensor	36	HWX20003909	2-point terminal block
18	HWX40001230	Coil	37	HWX20003504	Compressor capacitor 35 $\mu$ F
19	HWX200036005	Flow detector	38	HWX20009910	Capillary

# 6. APPENDICES (continued)

---

## ECP 08

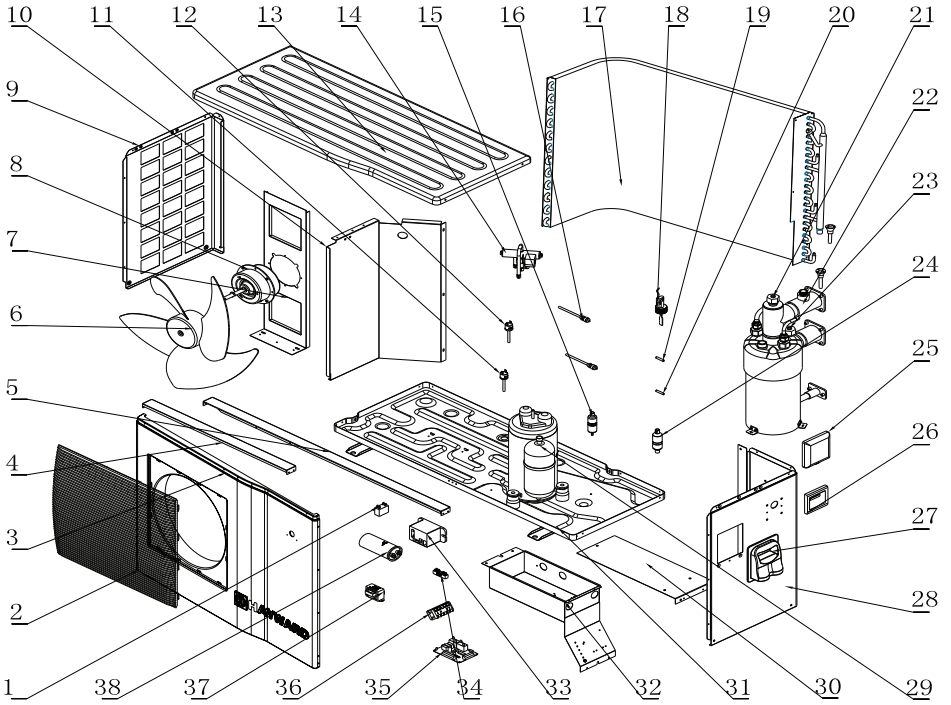



## 6. APPENDICES (continued)

### ECP 08

N	Ref.	Description	N	Ref.	Description
1	HWX20003501	Fan capacitor 3 $\mu$ F	21	HWX20003242	Temperature sensor
2	HWX35122213	Grille	22	HWX32081205	Titanium/PVC capacitor
3	HWX32012210240	Front ABS panel	23	HWX20003242	Temperature sensor
4	HWX321221175	Front stiffener	24	HWX20041445	Filter( $\Phi$ 9.7- $\Phi$ 4.2)
5	HWX321221018	Rear stiffener	25	HWX20002111	Controller protective cover
6	HWX35002701	Fan blade	26	HWX950531188	7-segment controller
7	HWX321221174	Motor bracket	27	HWX32009220054	Protection cover
8	HWX34043301	Fan motor	28	HWX32012210238	Right panel
9	HWX32012210238	Left panel	29	HWX200011135	Compressor
10	HWX321221173	Centre wall	30	HWX321221019	Electrical box cover
11	HWX20013605	High pressure switch	31	HWX32012210237	Frame
12	HWX20003603	Low pressure switch	32	HWX321221176	Electrical box
13	HWX32012210241	Top ABS cover	33	HWX20003619	Relay
14	HWX20011418	4-way valve	34	HWX20003909	2-point terminal block
15	HWX20041446	Filter (diam. 9.7 - diam. 3.4)	35	HWX950531145	PC1000 circuit board
16	HWX200014153	Schröder valve	36	HWX40003901	5-point terminal block
17	HWX34061204	Coil	37	HWX200037006	230V~/12V~ transformer
18	HWX200036005	Flow detector	38	HWX20003510	Compressor capacitor 60 $\mu$ F
19	HWX20003242	Temperature sensor	39	HWX20009909	Capillary
20	HWX20003242	Temperature sensor			

# 6. APPENDICES (continued)

---

## ECP 11

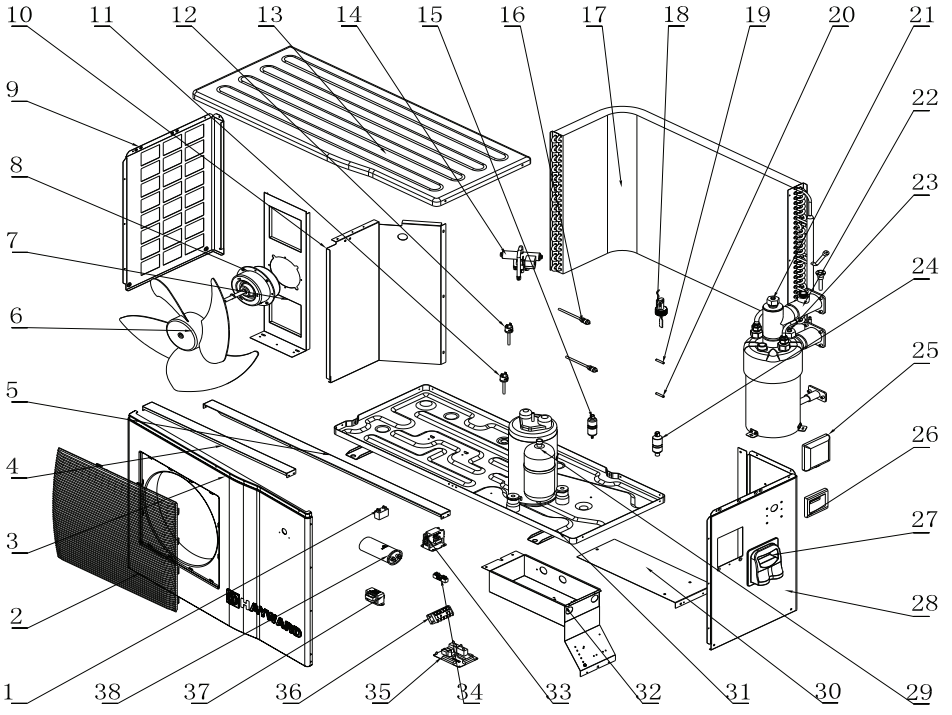

## 6. APPENDICES (continued)

### ECP 11

N	Ref.	Description	N	Ref.	Description
1	HWX20003501	Fan capacitor 3 $\mu$ F	21	HWX20003242	Temperature sensor
2	HWX35122213	Grille	22	HWX32121209	Titanium/PVC capacitor
3	HWX32012210240	Front ABS panel	23	HWX20003242	Temperature sensor
4	HWX321221175	Front stiffener	24	HWX20041445	Filter( $\Phi$ 9.7- $\Phi$ 4.2)
5	HWX321221018	Rear stiffener	25	HWX20002111	Controller protective cover
6	HWX35002701	Fan blade	26	HWX950531188	7-segment controller
7	HWX321221174	Motor bracket	27	HWX32009220054	Protection cover
8	HWX34043301	Fan motor	28	HWX32012210238	Right panel
9	HWX32012210238	Left panel	29	HWX200011135	Compressor
10	HWX321221173	Centre wall	30	HWX321221019	Electrical box cover
11	HWX20013605	High pressure switch	31	HWX32012210237	Frame
12	HWX20003603	Low pressure switch	32	HWX321221176	Electrical box
13	HWX32012210241	Top ABS cover	33	HWX20003619	Relay
14	HWX20011418	4-way valve	34	HWX20003909	2-point terminal block
15	HWX20041446	Filter (diam. 9.7 - diam. 3.4)	35	HWX950531145	PC1000 circuit board
16	HWX200014153	Schräder valve	36	HWX40003901	5-point terminal block
17	HWX321212002	Coil	37	HWX200037006	230V~/12V~ transformer
18	HWX200036005	Flow detector	38	HWX20003505	Compressor capacitor 60 $\mu$ F
19	HWX20003242	Temperature sensor	39	HWX20009909	Capillary
20	HWX20003242	Temperature sensor			

## 6. APPENDICES (continued)

---

### ECP 13

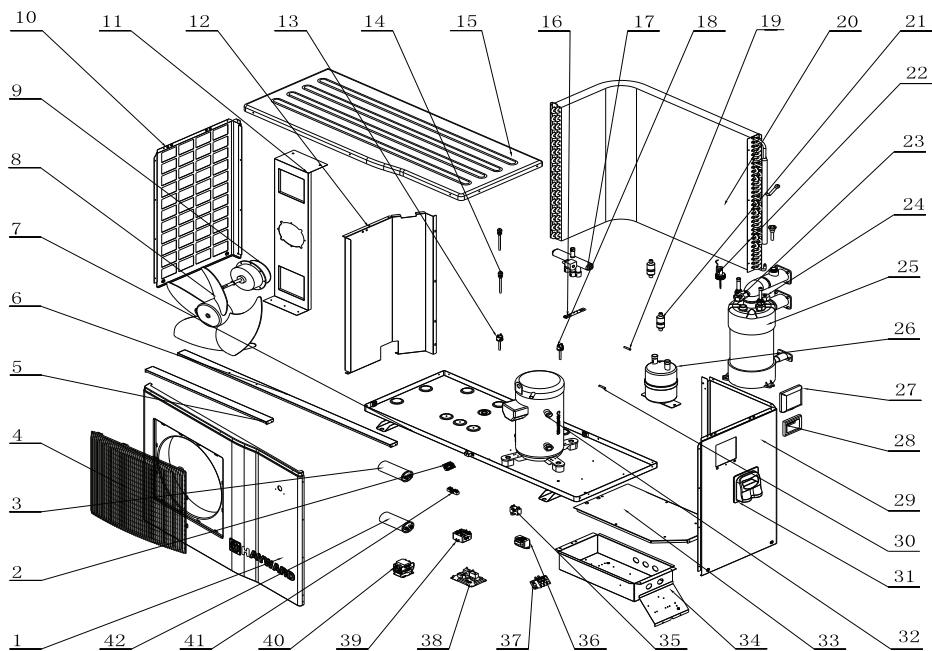

## 6. APPENDICES (continued)

### ECP 13

N	Ref.	Description	N	Ref.	Description
1	HWX32009210196	Front ABS panel	23	HWX20003242	Temperature sensor
2	HWX20003933	3-point terminal block	24	HWX20003242	Temperature sensor
3	HWX20003524	Start-up capacitor CPS 98 $\mu$ F	25	HWX32091206	Titanium/PVC capacitor
4	HWX35122213	Grille	26	HWX35001401	Battery
5	HWX320921015	Front stiffener	27	HWX20002111	Controller protective cover
6	HWX320921149	Rear stiffener	28	HWX950531188	7-segment controller
7	HWX320921144	Frame	29	HWX32009210194	Right panel
8	HWX35002701	Fan blade	30	HWX20003242	Temperature sensor
9	HWX34043301	Fan motor	31	HWX32009220054	Protection cover
10	HWX32009210195	Left panel	32	HWX20011170	Compressor
11	HWX320921147	Motor bracket	33	HWX320921152	Electrical box cover
12	HWX320921148	Centre wall	34	HWX320921151	Electrical box
13	HWX20013605	High pressure switch	35	HWX20003501	Fan capacitor 3 $\mu$ F
14	HWX200014153	Schröder valve	36	HWX200037006	230V~/12V~ transformer
15	HWX32009210197	Top ABS cover	37	HWX20003920	3-point terminal block
16	HWX20001489	Restrictor	38	HWX950531145	PC1000 circuit board
17	HWX20011491	4-way valve	39	HWX20003676	Relay
18	HWX20003603	Low pressure switch	40	HWX200036007	Compressor switch
19	HWX20003242	Temperature sensor	41	HWX20003909	2-point terminal block
20	HWX351212001	Coil	42	HWX20003510	Compressor capacitor 60 $\mu$ F
21	HWX20041444	Filter (diam. 9.7- diam. 9.7)	43	HWX20009909	Capillary
22	HWX200036005	Flow detector			

# 6. APPENDICES (continued)

---

## ECP 15

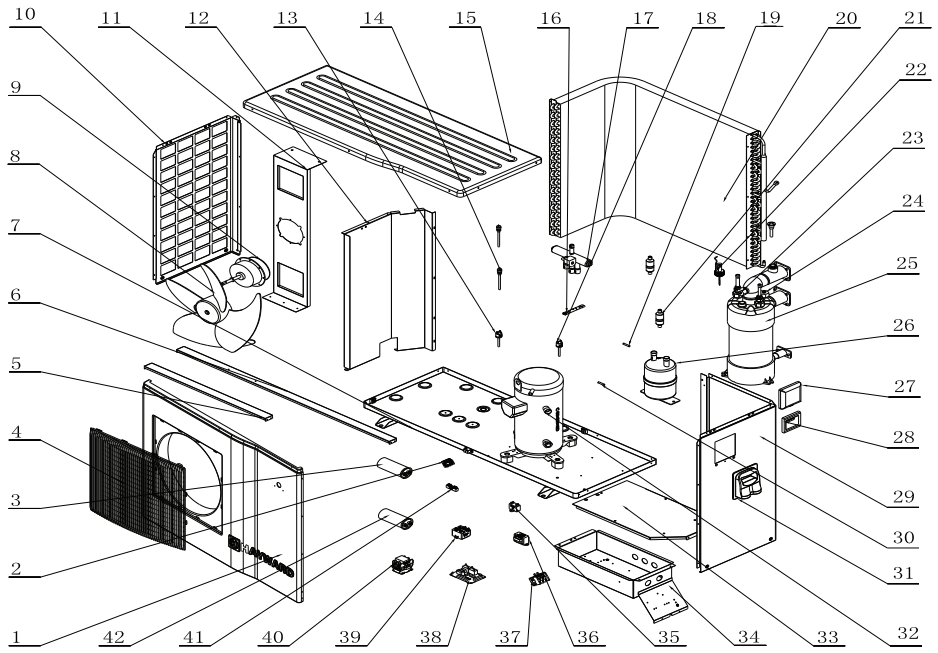

## 6. APPENDICES (continued)

### ECP 15

N	Ref.	Description	N	Ref.	Description
1	HWX32009210196	Front ABS panel	23	HWX20003242	Temperature sensor
2	HWX20003933	3-point terminal block	24	HWX20003242	Temperature sensor
3	HWX20003524	Start-up capacitor CPS 98 $\mu$ F	25	HWX32091206	Titanium/PVC capacitor
4	HWX35122213	Grille	26	HWX35001401	Battery
5	HWX320921015	Front stiffener	27	HWX20002111	Controller protective cover
6	HWX320921149	Rear stiffener	28	HWX950531188	7-segment controller
7	HWX32009210193	Frame	29	HWX32009210194	Right panel
8	HWX35002701	Fan blade	30	HWX20003242	Temperature sensor
9	HWX34043301	Fan motor	31	HWX32009220054	Protection cover
10	HWX32009210195	Left panel	32	HWX20011169	Compressor
11	HWX320921147	Motor bracket	33	HWX320921152	Electrical box cover
12	HWX320921148	Centre wall	34	HWX320921151	Electrical box
13	HWX20013605	High pressure switch	35	HWX20003501	Fan capacitor 3 $\mu$ F
14	HWX200014153	Schröder valve	36	HWX200037006	230V~/12V~ transformer
15	HWX32009210197	Top ABS cover	37	HWX20003920	3-point terminal block
16	HWX20001489	Restrictor	38	HWX950531145	PC1000 circuit board
17	HWX20011491	4-way valve	39	HWX20003676	Relay
18	HWX20003603	Low pressure switch	40	HWX200036007	Compressor switch
19	HWX20003242	Temperature sensor	41	HWX20003909	2-point terminal block
20	HWX351212001	Coil	42	HWX20003510	Compressor capacitor 60 $\mu$ F
21	HWX20041444	Filter (diam. 9.7- diam. 9.7)	43	HWX20009909	Capillary
22	HWX200036005	Flow detector			

## 6. APPENDICES (continued)

### 6.4 Troubleshooting guide



*Certain operations must be performed by an approved engineer.*

Fault	Error codes	Description	Solution
Water inlet sensor fault	P01	The sensor is open or has short-circuited.	Check or replace the sensor.
Water outlet sensor fault	P02	The sensor is open or has short-circuited.	Check or replace the sensor.
Outside temperature sensor fault	P04	The sensor is open or has short-circuited.	Check or replace the sensor.
De-icing sensor fault	P05	The sensor is open or has short-circuited.	Check or replace the sensor.
High pressure protection	E01	Refrigerating circuit pressure too high or water flow too low or coil obstructed or air flow too weak.	Check the high pressure switch and the refrigerating circuit pressure. Check the water or air flow. Check the flow controller is working properly. Check that the water inlet/outlet valves are opening. Check the by-pass settings.
Low pressure protection	E02	Refrigerating circuit pressure too low or air flow too weak or coil obstructed.	Check the low pressure switch and the refrigerating circuit pressure to see if there is a leak. Clean the coil surface. Check the fan rotation speed. Check the free circulation of air through the coil.
Flow sensor fault	E03	Insufficient water flow or sensor short-circuited or faulty	Check the water flow, check the filtration pump and flow sensor for any faults.
Temperature difference too great between the outlet and inlet water	E06	Insufficient water flow volume, water pressure difference too low/too high.	Check the water flow or for a system obstruction.
Antifreeze protection Cold mode	E07	Water outlet quantity too low.	Check the water flow rate or the outlet water temperature sensor.
Communication problem	E08	LED controller or PCB connection fault.	Check the wiring.
Level 1 antifreeze protection	E19	Air and inlet water temperature too low.	Turn off the heat pump and drain the capacitor. Freezing risk.
Level 2 antifreeze protection	E29	Air and inlet water temperature even lower.	Turn off the heat pump and drain the capacitor. Freezing risk.



## **6. APPENDICES (continued)**

---

### **6.5 Warranty**

#### **WARRANTY CONDITIONS**

All HAYWARD products are guaranteed to be free from manufacturing or material faults for a period of two years as from the date of purchase. Any claim made under the terms of the warranty must be accompanied by a dated proof of purchase. We therefore recommend that you keep your invoice.

The HAYWARD warranty is limited to the repair or replacement, at HAYWARD's discretion, of faulty products, provided they have been used under normal conditions, as described in their user guide, and that the product has not been modified in any way and has been used only with HAYWARD components and parts. Frost and chemical damage are not covered.

No other costs (transportation, labour, etc.) are covered by the warranty.

HAYWARD cannot be held liable for any direct or indirect damage caused by the incorrect installation, connection or operation of a product.

Please contact your retailer if you want to make a claim under the terms of the warranty and request the repair or replacement of an item. No equipment returned to our factory will be accepted without our prior written agreement.

Worn parts are not covered by the warranty.

# EASY TEMP

UNIDAD DE BOMBA DE CALOR PARA PISCINAS

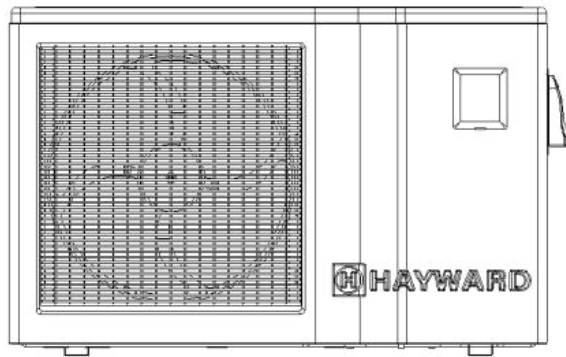

Manual de Instalación e Instrucciones

# SUMARIO

---

<b>1. Prefacio</b>	<b>1</b>
<hr/>	
<b>2. Características técnicas</b>	<b>2</b>
2.1 Datos técnicos de la bomba de calor	2
2.2 Intervalo de funcionamiento	3
2.3 Dimensiones	4
<hr/>	
<b>3. Instalación y conexión</b>	<b>5</b>
3.1 Diagrama de principio	5
3.2 Bomba de calor	5
3.3 Conexión hidráulica	6
3.4 Conexión eléctrica	7
3.5 Primer arranque	8
3.6 Ajuste del caudal de agua	10
<hr/>	
<b>4. Interfaz de usuario</b>	<b>11</b>
4.1 Presentación general	11
4.2 Ajuste del reloj	13
4.3 Ajuste de la función de temporizador	13
4.4 Selección del modo de funcionamiento: calentamiento o enfriamiento	14
4.5 Ajuste y visualización del punto de consigna	15
4.6 Bloqueo y desbloqueo de la interfaz del usuario	15
<hr/>	
<b>5. Mantenimiento e hibernación</b>	<b>16</b>
5.1 Mantenimiento	16
5.2 Hibernación	16
<hr/>	
<b>6. Anexos</b>	<b>17</b>
6.1 Diagramas eléctricos	17
6.2 Conexiones con prioridad de calentamiento	22
6.3 Vistas detalladas y piezas sueltas	23
6.4 Guía de mantenimiento y reparación	33
6.5 Garantía	34

Debe leerse atentamente y guardarse en un lugar accesible para futuras consultas.  
Este documento debe entregarse al propietario de la piscina, que debe conservarlo en un lugar seguro.

# 1. PREFACIO

---

Le agradecemos que haya comprado esta bomba de calor para piscina Easy Temp. Este producto se ha diseñado conforme a normas de fabricación estrictas para satisfacer los niveles de calidad más exigentes. Este manual incluye toda la información necesaria para la instalación, la resolución de fallos de funcionamiento y el mantenimiento. Lea este manual atentamente antes de abrir la unidad o realizar cualquier operación de mantenimiento en la misma. El fabricante de este producto declina toda responsabilidad en caso de lesiones del usuario o deterioro de la unidad debidos a posibles errores en la instalación, la resolución de fallos o el mantenimiento. Es esencial seguir en todo momento las instrucciones detalladas en este manual. La unidad debe instalarse personal capacitado.

- Las reparaciones debe efectuarlas personal capacitado.
- Todas las conexiones eléctricas debe realizarlas un electricista profesional certificado, en conformidad con las normas vigentes en el país de instalación, véase la sección 3.4.
- El mantenimiento y las distintas operaciones deben realizarse con la frecuencia y en los momentos recomendados, tal como se especifica en este manual.
- Utilice únicamente piezas de recambio originales.
- El incumplimiento de cualquier instrucción o recomendación anulará la garantía.
- Esta bomba de calor calienta el agua de la piscina y mantiene constante la temperatura, no debe utilizarse con otros fines.

Una vez leído el manual, guárdelo en un lugar accesible para futuras consultas. Advertencias sobre niños y personas con discapacidades físicas:

Este aparato no está destinado al uso por parte de niños, personas con discapacidades físicas, sensoriales o intelectuales ni personas sin la experiencia o los conocimientos necesarios, a menos que estén bajo supervisión de una persona responsable de su seguridad o ésta les haya facilitado las instrucciones pertinentes para el uso del aparato.

Este producto contiene gases de efecto invernadero, en el nivel permitido por el protocolo de Kyoto.

Tipo de refrigerante: R410A

Valor GWP<sup>(1)</sup>: 1975

Según los requisitos de la legislación europea o local, podría ser necesario realizar inspecciones periódicas de fuga de refrigerante. Póngase en contacto con su distribuidor local para más información.

---

(1) Potencial de calentamiento global

## 2. CARACTERÍSTICAS TÉCNICAS

### 2.1 Datos técnicos de la bomba de calor

Modelo	EASY TEMP	ECP 06	ECP 08	ECP 11	ECP 13	ECP 15
Capacidad calorífica *	kW BTU/h	5,5 18785	8 27322	11 37566	13.5 46105	15 51228
Potencia eléctrica	kW	1,17	1,8	2,43	3	3,13
Corriente de funcionamiento *	A	5,19	7,91	11,81	14,5	16
Alimentación eléctrica	V Ph/Hz	230 V ~ 1/50 Hz	230 V ~ 1/50 Hz	230 V ~ 1/50 Hz	230 V ~ 1/50 Hz	230 V ~ 1/50 Hz
Calibre fusible tipo aM	A	8 aM	10 aM	16 aM	20 aM	20 aM
Disyuntor curva D	A	8 D	10 D	16 D	20 D	20 D
Número de compresores		1	1	1	1	1
Tipo de compresor		Rotativo	Rotativo	Rotativo	Scroll	Scroll
Número de ventiladores		1	1	1	1	1
Potencia del ventilador	W	50	120	120	120	120
Velocidad de rotación del ventilador	RPM	770	850	850	850	850
Dirección del ventilador		Horizontal	Horizontal	Horizontal	Horizontal	Horizontal
Nivel de presión sonora (a 1 metro)	dB(A)	47	51	54	56	56
Conexión hidráulica	mm	50	50	50	50	50
Caudal de agua	m <sup>3</sup> /h	2,3	3,0	4,5	5,3	6,6
Pérdida de carga en el agua (máx.)	kPa	5,4	8,9	19,2	5,2	39,9
Dimensiones netas de la unidad (L/I/AI)	mm	895/375/545	1035/415/650	1035/415/650	1136/440/870	1136/440/870
Dimensiones de la unidad embalada (L/I/AI)	mm	970/430/710	1120/480/810	1180/480/810	1230/510/1020	1230/510/1020
Peso neto / peso de la unidad embalada	kg	45/56	54/68	60/74	95/115	117/128



\* Valor a +/- 5% en las siguientes condiciones: Temperatura exterior = 24°C (75°F) / HR=62% / Temperatura de la piscina=27°C (80°F)

## 2. CARACTERÍSTICAS TÉCNICAS (continuación)

---

### 2.2 Intervalo de funcionamiento

Utilice la bomba de calor en los intervalos de temperatura y humedad siguientes para garantizar un funcionamiento seguro y eficaz.

	Modo de calentamiento 	Modo de enfriamiento 
Temperatura exterior	+2°C ~ +35°C	+7°C ~ +43°C
Temperatura de agua	+12°C ~ +40°C	+8°C ~ +40°C
Humedad relativa	< 80%	< 80%
Intervalo de ajuste del punto de consigna	+15°C ~ +40°C	+8°C ~ +35°C



***Si la temperatura o la humedad no corresponden a estas condiciones, podrían activarse dispositivos de seguridad e impedir el funcionamiento de la bomba.***

## 2. CARACTERÍSTICAS TÉCNICAS (continuación)

### 2.3 Dimensiones

Modelos: ECP06 / ECP08 / ECP11 / ECP13 / ECP15

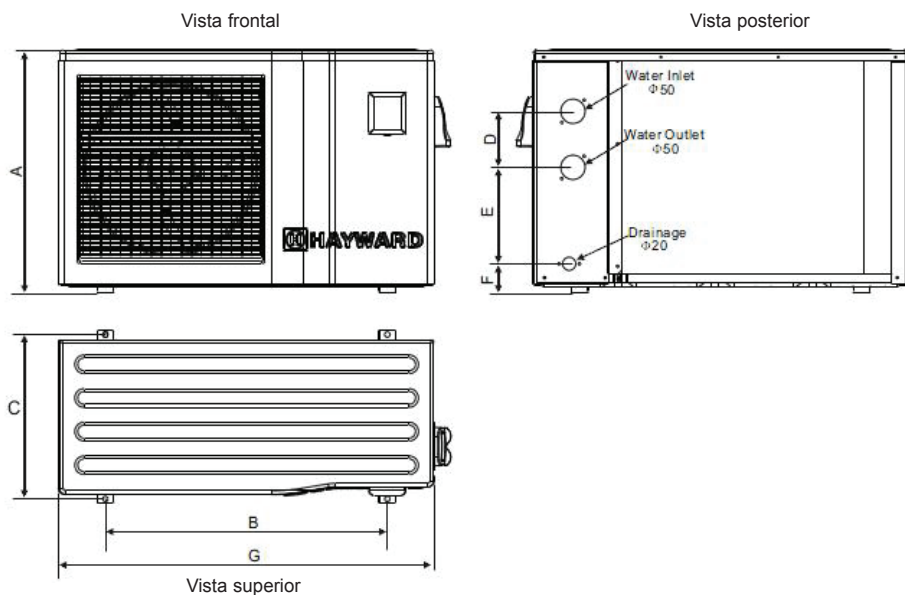

Unidad: mm

Modelo Referencia	ECP06	ECP08 ECP11	ECP13 ECP15
<b>A</b>	540	648	866
<b>B</b>	571	755	840
<b>C</b>	400	440	470
<b>D</b>	140	150	150
<b>E</b>	258	258	330
<b>F</b>	66	77	80
<b>G</b>	860	1004	1114

### 3. INSTALACIÓN Y CONEXIÓN

#### 3.1 Diagrama de principio

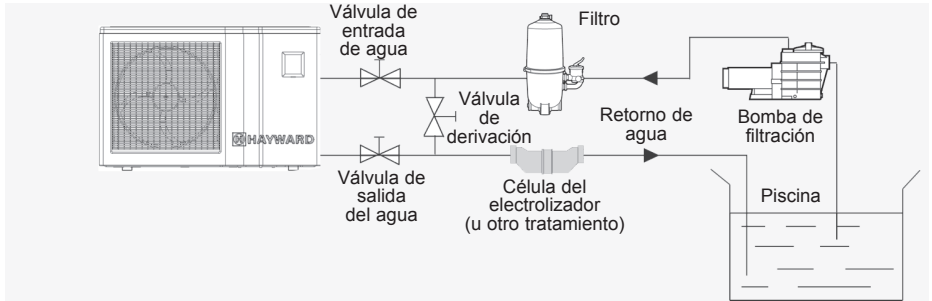

Nota: La bomba de calor se entrega sin ningún equipamiento de tratamiento ni filtración. Los elementos incluidos en el diagrama son piezas que debe suministrar el instalador.

#### 3.2 Bomba de calor



**Coloque la bomba de calor en el exterior, fuera de cualquier local técnico cerrado.**

**Cuando esté bajo techo, deben respetarse las distancias mínimas abajo indicadas para evitar riesgos de recirculación del aire y degradación del rendimiento general de la bomba de calor.**

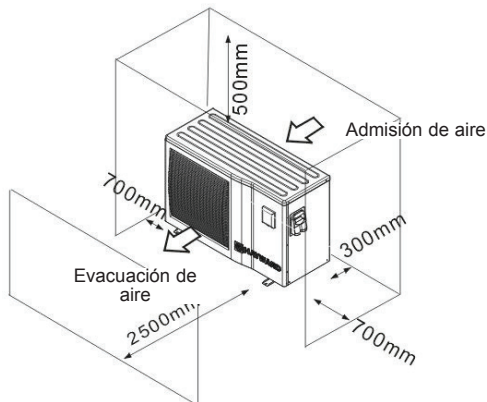



### 3. INSTALACIÓN Y CONEXIÓN (continuación)

---



***De preferencia, instale la bomba de calor en una losa de cemento suelta o un soporte de fijación previsto a tal efecto y monte la bomba de calor sobre los silentblocs incluidos (tornillos y arandelas no incluidos).***

***Distancia máxima de instalación entre la bomba de calor y la piscina 15 metros.***

***Longitud total de ida y vuelta de las canalizaciones hidráulicas de 30 metros.***

***Las canalizaciones hidráulicas de superficie deben aislarse y enterrarse.***

#### 3.3 Conexión hidráulica

La bomba de calor se entrega con dos conectores de 50 mm de diámetro. Utilice un tubo de PVC para canalización hidráulica Ø 50 mm. Conecte la entrada de agua de la bomba de calor al conducto procedente del equipo de filtración, y la salida de agua de la bomba al conducto que se dirige a la piscina (véase el diagrama de abajo).

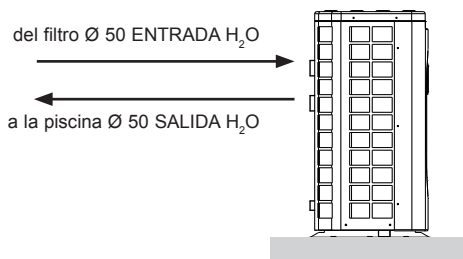

Instale una válvula de derivación entre la entrada y la salida de la bomba de calor.



***Si se utiliza un distribuidor automático o un electrolizador, debe instalarse obligatoriamente después de la bomba de calor, a fin de proteger el condensador de titanio contra una concentración excesiva de productos químicos.***



***Instale correctamente la válvula de derivación y los conectores incluidos en la entrada y la salida de agua de la unidad, a fin de facilitar la purga durante el periodo invernal, así como el acceso y el desmontaje para tareas de mantenimiento.***

### 3. INSTALACIÓN Y CONEXIÓN (continuación)

#### 3.4 Conexión eléctrica



**La instalación eléctrica y el cableado de este equipo deben cumplir las normas locales de instalación vigentes.**

F	NF C15-100	GB	BS7671:1992
D	DIN VDE 0100-702	EW	EVHS-HD 384-7-702
A	ÖVE 8001-4-702	H	MSZ 2364-702/1994/MSZ 10-553 1/1990
E	UNE 20460-7-702 1993, RECBT ITC-BT-31 2002	M	MSA HD 384-7-702.S2
IRL	Wiring Rules + IS HD 384-7-702	PL	PN-IEC 60364-7-702:1999
I	CEI 64-8/7	CZ	CSN 33 2000 7-702
LUX	384-7.702 S2	SK	STN 33 2000-7-702
NL	NEN 1010-7-702	SLO	SIST HD 384-7-702.S2
P	RSIUEE	TR	TS IEC 60364-7-702



**Compruebe que la alimentación eléctrica disponible y la frecuencia de la red corresponden a la corriente de funcionamiento necesaria, teniendo en cuenta el emplazamiento específico del aparato y la corriente necesaria para alimentar cualquier otro aparato conectado al mismo circuito.**

**ECP 06 230 V~ +/- 10 % 50 HZ 1 fase**

**ECP 08 230 V~ +/- 10 % 50 HZ 1 fase**

**ECP 11 230 V~ +/- 10 % 50 HZ 1 fase**

**ECP 13 230 V~ +/- 10 % 50 HZ 1 fase**

**ECP 15 230 V~ +/- 10 % 50 HZ 1 fase**

**Consulte el diagrama de cableado correspondiente en el anexo.**

**La caja de conexiones se encuentra en la parte derecha de la unidad.**

**Hay tres conexiones para alimentación eléctrica, y dos para control de la bomba de filtración (servomecanismo).**

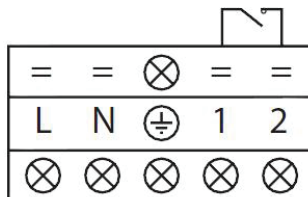

Alimentación general  
230V~ / 50Hz

Contacto seco libre de  
potencial de 7 A máx..

## 3. INSTALACIÓN Y CONEXIÓN (continuación)

---



**La línea de alimentación eléctrica debe estar equipada de un dispositivo de protección de fusibles de tipo alimentación del motor (aM) o disyuntor curva D, y de un disyuntor diferencial de 30 mA (véase la tabla de abajo).**

Modelos		ECP 06	ECP 08	ECP 11	ECP 13	ECP 15
Alimentación eléctrica	V/Ph/ Hz	230 V~ 1/50 Hz	230 V~ 1/50 Hz	230 V~ 1/50 Hz	230 V~ 1/50 Hz	230 V~ 1/50 Hz
Calibre fusible tipo aM	A	8 aM	10 aM	16 aM	20 aM	20 aM
Disyuntor curva D	A	8 D	10 D	16 D	20 D	20 D



**No olvide cortar siempre el suministro de alimentación antes de abrir la caja de control eléctrica.**

### 3.5 Primer arranque

Procedimiento de arranque; una vez finalizada la instalación, siga estos pasos:

- 1) Haga girar el ventilador con la mano para comprobar que se mueve libremente y la hélice está correctamente sujeta al árbol del motor.
- 2) Asegúrese de que la unidad está correctamente conectada al suministro de alimentación principal (véase el diagrama de cableado en el anexo).
- 3) Active la bomba de filtración.
- 4) Compruebe que todas las válvulas de agua están abiertas y el agua circula hacia la unidad antes de activar el modo de calentamiento o enfriamiento.
- 5) Compruebe que el tubo de purga de los condensados está correctamente fijado y no presenta obstrucciones.
- 6) Active la alimentación eléctrica de la unidad y seguidamente pulse el botón de funcionamiento/parada  en el panel de control.

### 3. INSTALACIÓN Y CONEXIÓN (continuación)

---

- 7) Asegúrese de que no se ve ningún código de ALARMA cuando la unidad está encendida (ON) (véase la guía de mantenimiento y reparación).
- 8) Fije el caudal de agua mediante la válvula de derivación (véanse las secciones 3.6 y 2.1), del modo previsto para cada modelo respectivamente, de forma que se obtenga una diferencia de temperatura de entrada/salida de 2°C.
- 9) Después de unos minutos de funcionamiento, compruebe que el aire que sale de la unidad se ha enfriado (entre 5 y 10°).
- 10) Con la unidad en funcionamiento, desactive la bomba de filtración. La unidad debe pararse automáticamente e indicar el código de error E03.
- 11) Haga funcionar la unidad y la bomba de la piscina durante 24 horas al día hasta que el agua alcance la temperatura deseada. Cuando la temperatura de entrada del agua alcanza el valor configurado, la unidad se para. Vuelve a arrancar automáticamente (siempre que la bomba de la piscina esté en funcionamiento) cuando la temperatura de la piscina baja 0,5°C o más con respecto a la temperatura configurada.

**Controlador de caudal** – La unidad está equipada con un controlador de caudal que activa la bomba de calor cuando la bomba de filtración de la piscina está en funcionamiento, y la desactiva cuando la bomba de filtración está fuera de funcionamiento. Si no hay agua, se visualiza el código de alarma E03 en el regulador (véase la sección 6.4).

**Temporización** – la unidad integra una temporización de 3 minutos para proteger los componentes del circuito de control y eliminar la inestabilidad en el arranque y las interferencias en el contactor. Gracias a esta temporización, la unidad arranca automáticamente unos 3 minutos después de cualquier corte del circuito de control. Hasta los cortes de corriente breves activan la temporización de arranque.

### 3. INSTALACIÓN Y CONEXIÓN (continuación)

#### 3.6 Ajuste del caudal de agua

Cuando la bomba de calor está en funcionamiento y las válvulas de entrada y salida de agua están abiertas, ajuste la válvula de derivación (“bypass”) de forma que obtenga una diferencia de 2°C entre la temperatura de entrada y la de salida del agua (véase el diagrama de principio, sección 3.1). Puede comprobar el ajuste visualizando las temperaturas de entrada (T02) y salida (T03) directamente en el panel de control, conforme al procedimiento detallado a continuación.

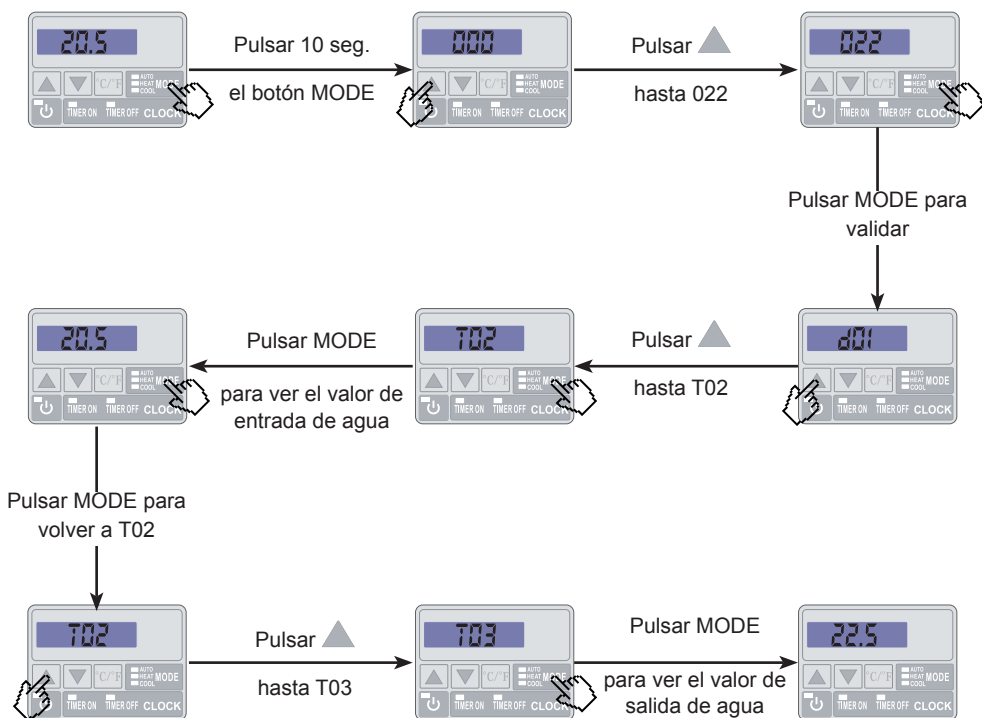

A continuación, ajuste la válvula de derivación de forma que obtenga una diferencia de 2°C entre T03 y T02 ( $T03 - T02 = \Delta T = 2$ ).

Pulse  2 veces para salir del menú.

Nota: La apertura de la válvula de derivación genera un caudal inferior, por lo que aumenta el  $\Delta T$ .

El cierre de la válvula de derivación genera un caudal superior, por lo que disminuye el  $\Delta T$ .

## 4. INTERFAZ DEL USUARIO

---

### 4.1 Presentación general

La bomba de calor está equipada con un panel de control electrónico, con conexión eléctrica y preconfigurado en fábrica en modo de calentamiento.

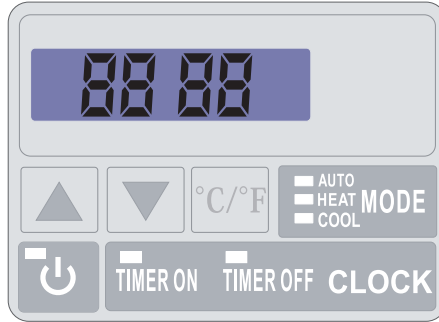

#### Leyenda

- SÍMBOLO DEL MODO DE ENFRÍAMIENTO
- SÍMBOLO DEL MODO DE CALENTAMIENTO
- MODO AUTOMÁTICO
- AJUSTE DE LA HORA Y EL TEMPORIZADOR
- BOTÓN DE SELECCIÓN Y AJUSTE
- BOTÓN DE FUNCIONAMIENTO/PARADA Y RETORNO/VALIDACIÓN
- DESPLAZAMIENTO HACIA ABAJO
- DESPLAZAMIENTO HACIA ARRIBA
- AJUSTE DE LA HORA DE PUESTA EN MARCHA
- AJUSTE DE LA HORA DE PARADA

## 4. INTERFAZ DE USUARIO (continuación)

---

### Modo OFF (APAGADO)

Cuando la bomba de calor está en espera (modo OFF), se ven la hora y el modo de funcionamiento en la pantalla del regulador.

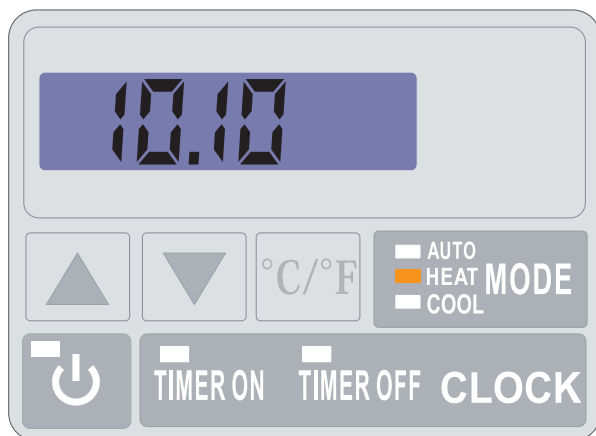

### Modo ON



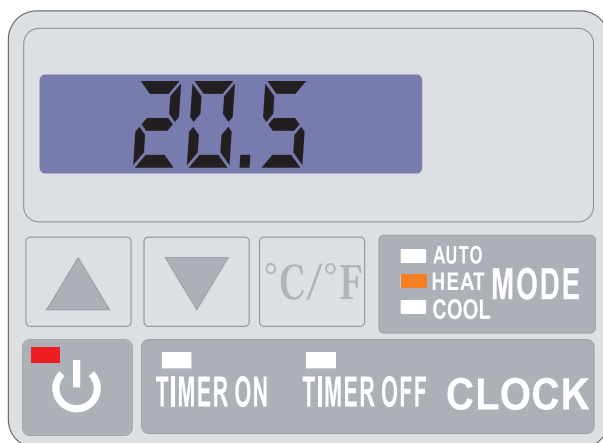

Cuando la bomba de calor está en funcionamiento o en proceso de regulación (modo ON), el piloto del botón de funcionamiento se ilumina en rojo y la temperatura de entrada del agua se ve en la pantalla.



## 4. INTERFAZ DE USUARIO (continuación)

---

### 4.2 Ajuste del reloj





El reloj puede ajustarse en modo ON y OFF. Pulse «CLOCK»; la visualización parpadea, y al pulsarlo de nuevo parpadean las horas. Ajuste las horas con las flechas  o  y después pulse «CLOCK» de nuevo para seleccionar los minutos. Ajuste los minutos mediante las flechas.  o . Pulse «CLOCK» para validar. La pantalla vuelve a su estado anterior.

Nota: Los ajustes se guardan pulsando el botón «CLOCK» o automáticamente si no se activa ninguna tecla durante 5 segundos.

### 4.3 Ajuste de la función de temporizador

Es necesario configurar esta función si desea que su bomba de calor funcione durante un periodo de tiempo inferior al definido por el reloj de filtración. Permite programar un arranque aplazado y una parada anticipada, o simplemente bloquear un intervalo horario de funcionamiento (por ejemplo la noche).





#### Programación de inicio (temporizador ON) / funcionamiento

- 1) Pulse «Timer ON»; la hora parpadea.
- 2) Pulse «Timer ON» para ajustar las horas mediante los botones  .
- 3) Pulse «Timer ON» para ajustar los minutos mediante los botones  .

Los ajustes se guardan pulsando el botón «Timer ON» o automáticamente si no se activa ninguna tecla durante 5 segundos.

Un piloto verde indica que el temporizador está activado.

#### Programación de parada (Timer OFF) / Parada

- 1) Pulse «Timer OFF»; la hora parpadea.
- 2) Pulse «Timer OFF» para ajustar las horas mediante los botones  .
- 3) Pulse «Timer OFF» para ajustar los minutos mediante los botones  .

Los ajustes se guardan pulsando el botón «Timer OFF» o automáticamente si no se activa ninguna tecla durante 5 segundos.

Un piloto rojo indica que el temporizador está activado.



---



## 4. INTERFAZ DE USUARIO (continuación)

---

### Supresión de los temporizadores (Timer ON y OFF) / Parada y funcionamiento

- 1) Pulse «Timer ON», que comenzará a parpadear.
- 2) Pulse  para suprimir la programación.
- 3) Pulse «Timer OFF», que comenzará a parpadear.
- 4) Pulse  para suprimir la programación.

### 4.4 Selección del modo de funcionamiento: calentamiento, enfriamiento o automático.

#### En modo “OFF” u “ON”

Pulse el botón «MODE» para alternar entre el modo de enfriamiento (piloto verde), el modo de calentamiento (piloto naranja) y el modo automático (piloto rojo).

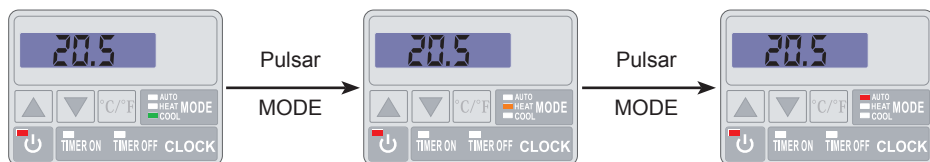



## 4. INTERFAZ DE USUARIO (continuación)

---



### 4.5 Ajuste y visualización del punto de consigna (temperatura del agua deseada)

En modo “OFF” y modo “ON”

Pulse los botones  o  para definir el punto de consigna deseado. El ajuste se realiza con una precisión de 0,5°C.



***Se recomienda no superar nunca la temperatura de 30°C para evitar el deterioro de los liners.***

Nota: En funcionamiento o parada, basta con pulsar el botón  o  para visualizar o modificar el punto de consigna.

### 4.6 Bloqueo y desbloqueo de la pantalla táctil

Pulse el botón de funcionamiento/parada  durante 5 seg. hasta que la unidad emita un pitido. Las teclas se desactivan.

Para desbloquearla, pulse el botón  durante 5 seg. hasta que la unidad emita un pitido.

Las teclas se activan de nuevo.

## 5. MANTENIMIENTO E HIBERNACIÓN

---

### 5.1 Mantenimiento

Estas operaciones de mantenimiento deben realizarse una vez al año para garantizar la larga duración y el correcto funcionamiento de la bomba de calor.

- Limpiar el evaporador con un cepillo suave o un chorro de aire/agua (**Atención, no utilizar nunca un limpiador a alta presión**).
- Comprobar la correcta circulación de los condensados.
- Comprobar el apriete de los conectores hidráulicos y eléctricos.



***Antes de realizar cualquier operación de mantenimiento, es necesario desconectar la bomba de calor de todo suministro eléctrico. Las operaciones de mantenimiento debe realizarlas únicamente personal capacitado para manipular fluidos frigorígenos.***

- Comprobar la estanqueidad hidráulica del condensador.

### 5.2 Hibernación

- Colocar la bomba de calor en modo “OFF”.
- Cortar la alimentación de la bomba de calor.
- Vaciar el condensador mediante el mecanismo de vaciado para evitar riesgos de deterioro. (Riesgo importante de congelación).
- Cerrar la válvula de derivación y desatornillar los conectores de entrada/salida.
- Expulsar el agua estancada residual del condensador mediante una pistola de aire.
- Obturar la entrada y la salida de agua de la bomba de calor para evitar la entrada de cuerpos extraños.
- Cubrir la bomba de calor con una cubierta de hibernación (no incluida).



***Cualquier daño derivado de una hibernación incorrecta anulará la garantía.***

# 6. ANEXOS

## 6.1 Diagramas eléctricos

ECP 06

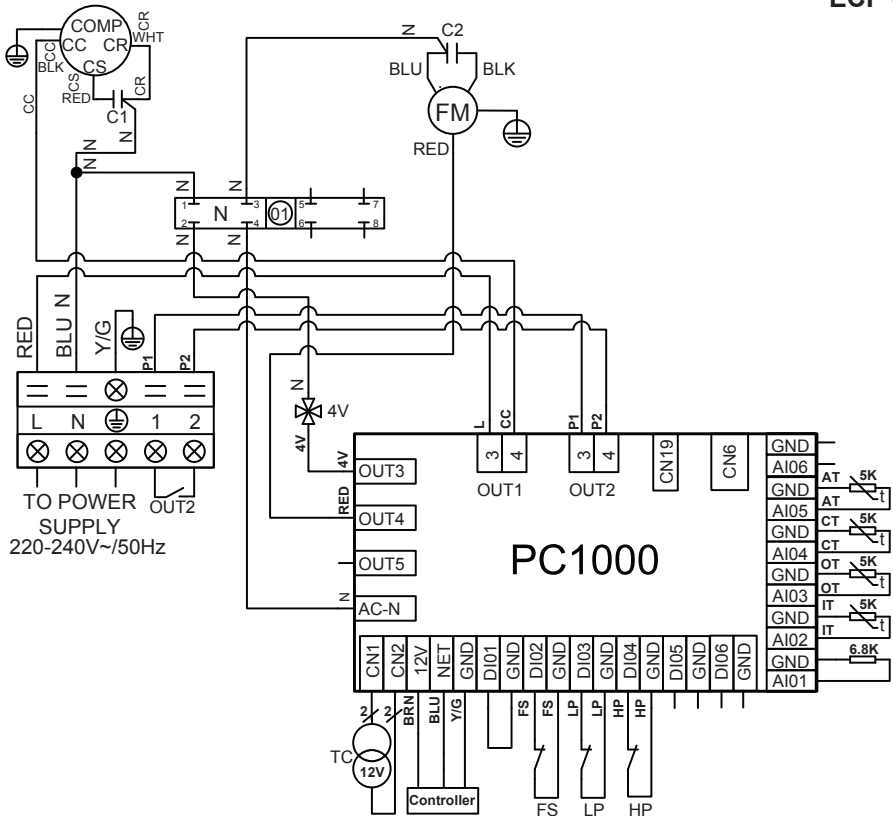

**OBSERVACIONES:**

- AT: SONTA DE TEMPERATURA DEL AIRE
- COMP: COMPRESOR
- CT: SONTA DE TEMPERATURA DEL EVAPORADOR
- FM: MOTOR DEL VENTILADOR
- FS: DETECTOR DE PRESENCIA DE AGUA
- HP: PRESOSTATO DE ALTA PRESIÓN
- IT: SONTA DE TEMPERATURA DE ENTRADA DEL AGUA
- LP: PRESOSTATO DE BAJA PRESIÓN

- OT: SONTA DE TEMPERATURA DE SALIDA DEL AGUA
- TC: TRANSFORMADOR 230V~ / 12V~
- 4V: VÁLVULA DE 4 VÍAS
- C1: CONDENSADOR COMPRESOR
- C2: CONDENSADOR VENTILADOR
- OUT2 : CONTACTO SECO LIBRE DE 7 A MÁX. DE POTENCIAL

## 6. ANEXOS (continuación)

ECP 08

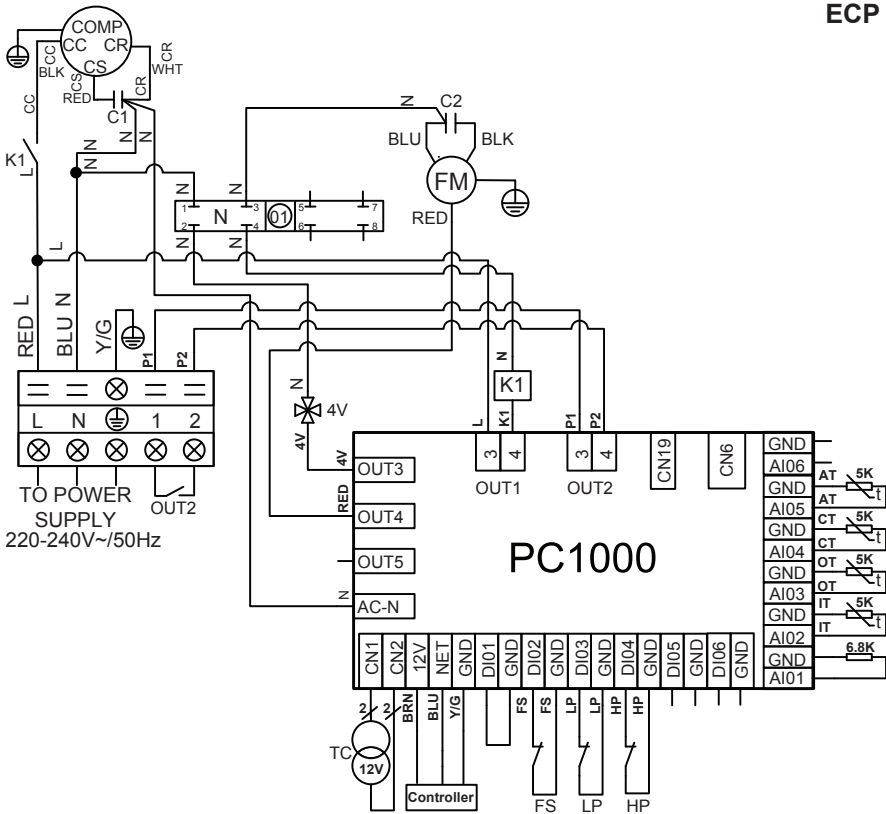

### OBSERVACIONES:

AT: SONDA DE TEMPERATURA DEL AIRE  
 COMP: COMPRESOR  
 CT: SONDA DE TEMPERATURA DEL EVAPORADOR  
 FM: MOTOR DEL VENTILADOR  
 FS: DETECTOR DE PRESENCIA DE AGUA  
 HP: PRESOSTATO DE ALTA PRESIÓN  
 IT: SONDA DE TEMPERATURA DE ENTRADA DEL AGUA

LP: PRESOSTATO DE BAJA PRESIÓN  
 OT: SONDA DE TEMPERATURA DE SALIDA DEL AGUA  
 TC: TRANSFORMADOR 230V~/ 12V~  
 4V: VÁLVULA DE 4 VÍAS  
 K1: RELÉ COMPRESOR  
 C1: CONDENSADOR COMPRESOR  
 C2: CONDENSADOR VENTILADOR  
 OUT2 : CONTACTO SECO LIBRE DE 7 A MÁX. DE POTENCIAL

# 6. ANEXOS (continuación)

ECP 11

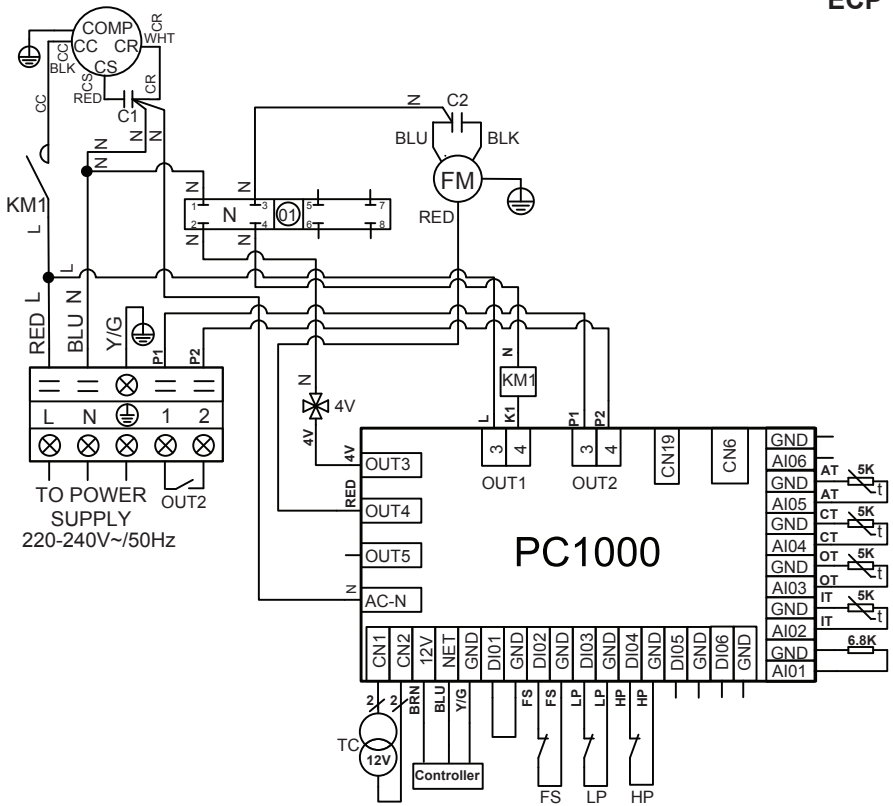

**OBSERVACIONES:**

- AT: SONDA DE TEMPERATURA DEL AIRE
- COMP: COMPRESOR
- CT: SONDA DE TEMPERATURA DEL EVAPORADOR
- FM: MOTOR DEL VENTILADOR
- FS: DETECTOR DE PRESENCIA DE AGUA
- HP: PRESOSTATO DE ALTA PRESIÓN
- IT: SONDA DE TEMPERATURA DE ENTRADA DEL AGUA

- LP: PRESOSTATO DE BAJA PRESIÓN
- OT: SONDA DE TEMPERATURA DE SALIDA DEL AGUA
- TC: TRANSFORMADOR 230V~/ 12V~
- 4V: VÁLVULA DE 4 VÍAS
- KM1: CONTACTOR DE POTENCIA DEL COMPRESOR
- C1: CONDENSADOR COMPRESOR
- C2: CONDENSADOR VENTILADOR
- OUT2 : CONTACTO SECO LIBRE DE 7 A MÁX. DE POTENCIAL

## 6. ANEXOS (continuación)

ECP 13

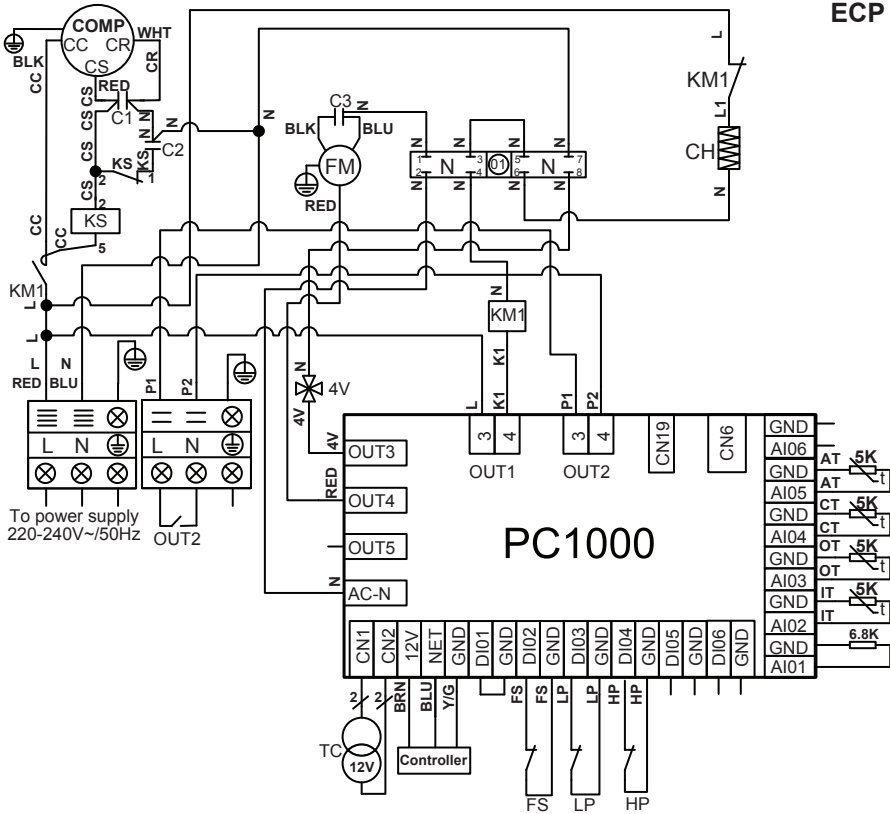

### OBSERVACIONES:

AT: SONDAS DE TEMPERATURA DEL AIRE  
 COMP: COMPRESOR  
 CH: RESISTENCIA DEL CÁRTER  
 CT: SONDAS DE TEMPERATURA DEL EVAPORADOR  
 FM: MOTOR DEL VENTILADOR  
 FS: DETECTOR DE PRESENCIA DE AGUA  
 HP: PRESOSTATO DE ALTA PRESIÓN  
 IT: SONDAS DE TEMPERATURA DE ENTRADA DEL AGUA

KS: BOBINA DEL RELÉ DE ARRANQUE DEL COMPRESOR  
 LP: PRESOSTATO DE BAJA PRESIÓN  
 OT: SONDAS DE TEMPERATURA DE SALIDA DEL AGUA  
 TC: TRANSFORMADOR 230V~/ 12V~  
 4V: VÁLVULA DE 4 VÍAS  
 KM1: CONTACTOR DE POTENCIA DEL COMPRESOR  
 C1: CONDENSADOR PERMANENTE  
 C2: CONDENSADOR DE ARRANQUE  
 OUT2 : CONTACTO SECO LIBRE DE 7 A MÁX. DE POTENCIAL

## 6. ANEXOS (continuación)

ECP 15

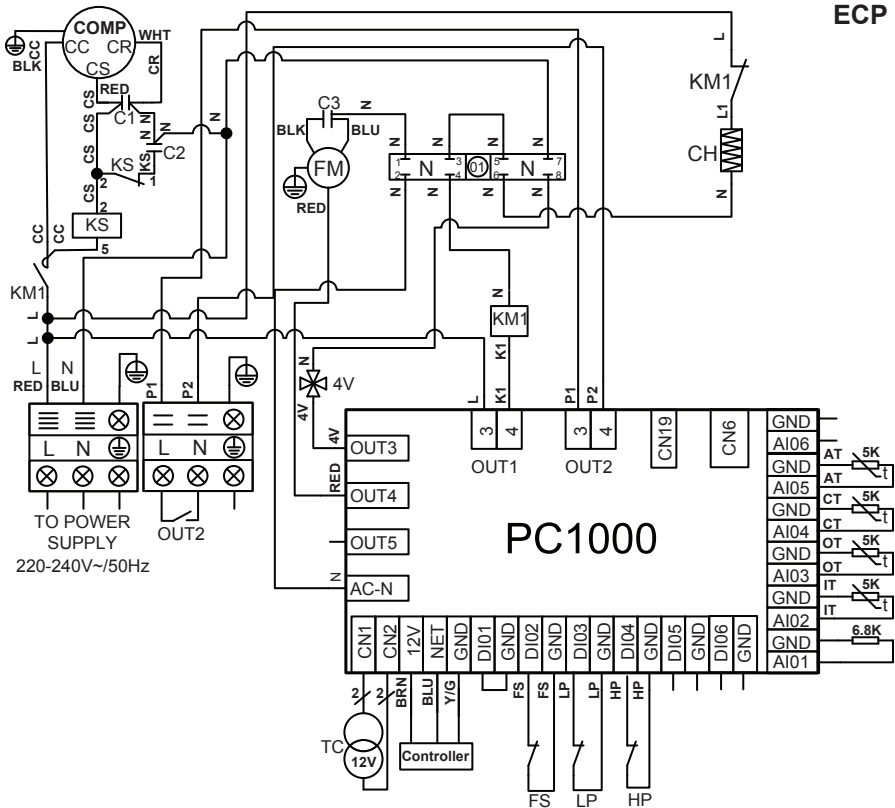

### OBSERVACIONES:

AT: SONDA DE TEMPERATURA DEL AIRE  
 COMP: COMPRESOR  
 CH: RESISTENCIA DEL CÁRTER  
 CT: SONDA DE TEMPERATURA DEL EVAPORADOR  
 FM: MOTOR DEL VENTILADOR  
 FS: DETECTOR DE PRESENCIA DE AGUA  
 HP: PRESOSTATO DE ALTA PRESIÓN  
 IT: SONDA DE TEMPERATURA DE ENTRADA DEL AGUA

KS: BOBINA DEL RELÉ DE ARRANQUE DEL COMPRESOR  
 LP: PRESOSTATO DE BAJA PRESIÓN  
 OT: SONDA DE TEMPERATURA DE SALIDA DEL AGUA  
 TC: TRANSFORMADOR 230V~/ 12V~  
 4V: VÁLVULA DE 4 VÍAS  
 KM1: CONTACTOR DE POTENCIA DEL COMPRESOR  
 C1: CONDENSADOR PERMANENTE  
 C2: CONDENSADOR DE ARRANQUE  
 OUT2 : CONTACTO SECO LIBRE DE 7 A MÁX. DE POTENCIAL



## 6. ANEXOS (continuación)

### 6.2 Conexiones con prioridad de calentamiento Bomba monofásica

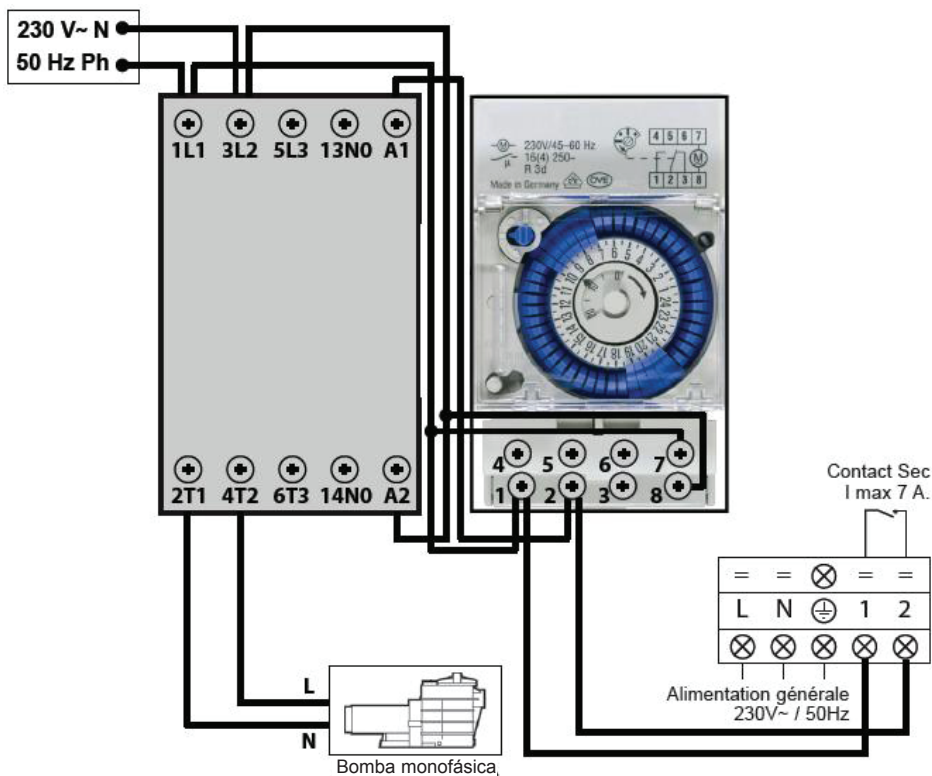

Los bornes 1 et 2 suministran un contacto seco (libre de potencial), sin polaridad de 230 V~ / 50 Hz. Conecte los cables a los bornes 1 y 2 respetando el esquema de cableado que se indica a continuación para que la bomba de filtración funcione por ciclos de 2 min cada hora en caso de que la temperatura de la piscina sea inferior al punto de consigna.

 No conecte nunca la alimentación de la bomba de filtración directamente a los bornes 1 y 2.



## 6. ANEXOS (continuación)

### 6.3 Vistas detalladas y piezas sueltas

ECP 06

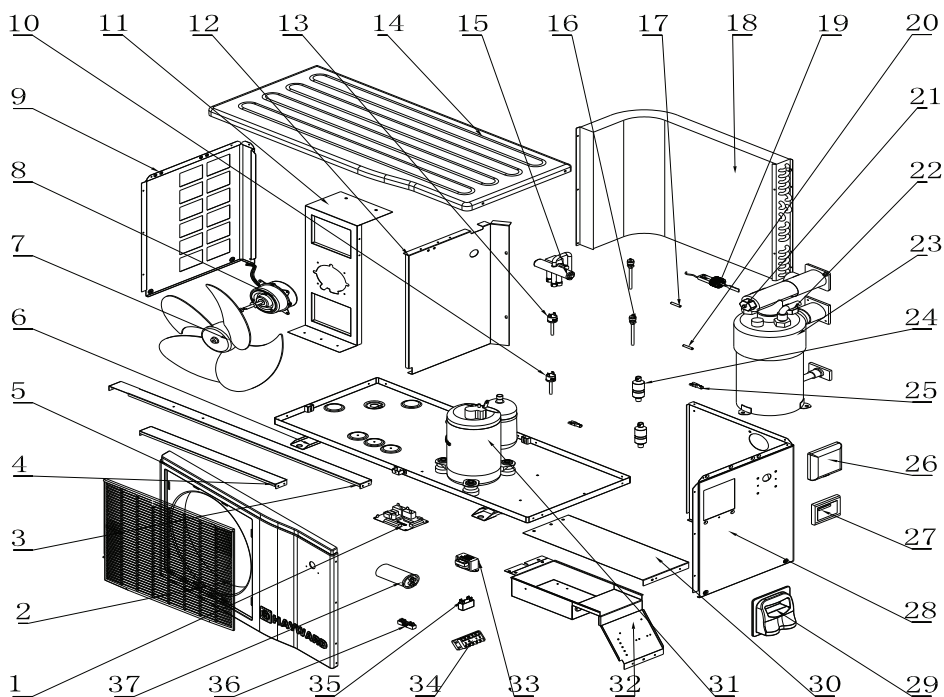

## 6. ANEXOS (continuación)

### ECP 06

Nº	Ref.	Designación	Nº	Ref.	Designación
1	HWX950531145	Tarjeta electrónica PC1000	20	HWX20003242	Sonda de temperatura
2	HWX35252208	Rejilla	21	HWX20003242	Sonda de temperatura
3	HWX322521062	Tensor trasero	22	HWX20003242	Sonda de temperatura
4	HWX322521063	Tensor delantero	23	HWX35251210	Condensador de titanio/PVC
5	HWX32025210084	Panel ABS delantero	24	HWX20041444	Filtro (Ø9.7-Ø9.7)
6	HWX32025210081	Chasis	25	HWX200014068	Conector capilar
7	HWX34012701	Aspa del ventilador	26	HWX20002111	Protección del controlador
8	HWX34013301	Motor del ventilador	27	HWX950531188	Controlador de 7 segmentos
9	HWX32025210083	Panel de la izquierda	28	HWX32025210082	Panel derecho
10	HWX20003603	Presostato baja presión	29	HWX32009220054	Mango
11	HWX322521061	Soporte del motor	30	HWX322521064	Panel de protección eléctrica
12	HWX322521059	Panel de separación	31	HWX200011006	Compresor
13	HWX20013605	Presostato de alta presión	32	HWX322521006	Caja eléctrica
14	HWX32025210085	Panel ABS superior	33	HWX200037006	Transformador 230V~/12V~
15	HWX20011418	Válvula de 4 vías	34	HWX40003901	Regleta de terminales de 5 conexiones
16	HWX200014153	Válvula Shrader	35	HWX20003506	Condensador ventilador 2µF
17	HWX20003242	Sonda de temperatura	36	HWX20003909	Regleta de terminales de 2 conexiones
18	HWX40001230	Evaporador	37	HWX20003504	Condensador compresor 35µF
19	HWX200036005	Detector del caudal	39	HWX20009910	Capilar

## 6. ANEXOS (continuación)

### ECP 08

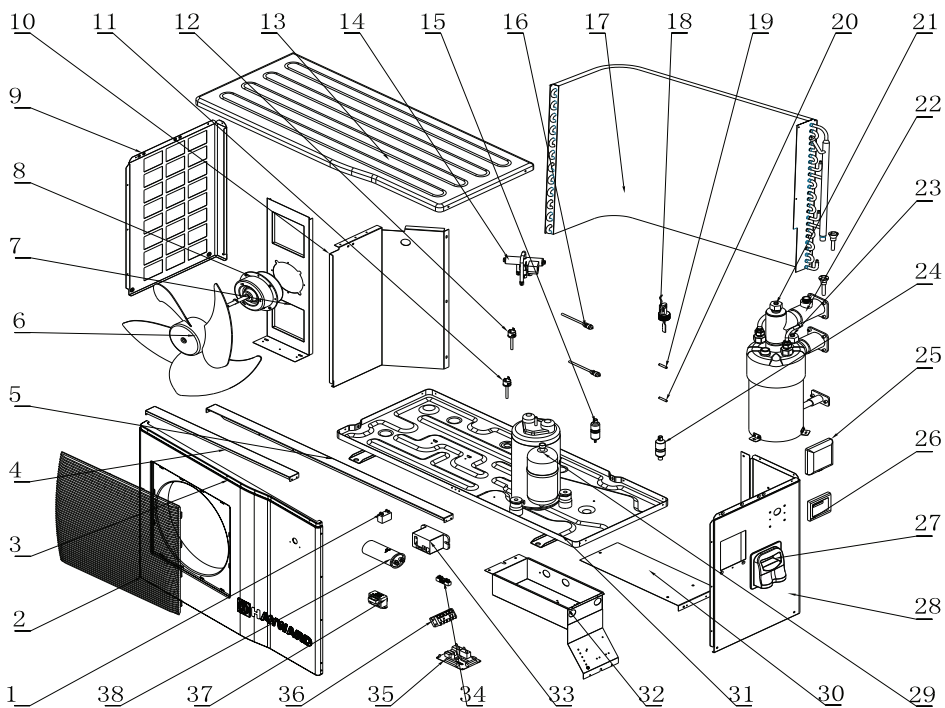

## 6. ANEXOS (continuación)

### ECP 08

Nº	Ref.	Designación	Nº	Ref.	Designación
1	HWX20003501	Condensador ventilador 3µF	21	HWX20003242	Sonda de temperatura
2	HWX35122213	Rejilla	22	HWX32081205	Condensador de titanio/PVC
3	HWX32012210240	Panel ABS delantero	23	HWX20003242	Sonda de temperatura
4	HWX321221175	Tensor delantero	24	HWX20041445	Filter(Φ9.7-Φ4.2)
5	HWX321221018	Tensor trasero	25	HWX20002111	Protección del controlador
6	HWX35002701	Aspa del ventilador	26	HWX950531188	Controlador de 7 segmentos
7	HWX321221174	Soporte del motor	27	HWX32009220054	Mango
8	HWX34043301	Motor del ventilador	28	HWX32012210238	Panel derecho
9	HWX32012210238	Panel de la izquierda	29	HWX200011135	Compresor
10	HWX321221173	Panel de separación	30	HWX321221019	Panel de protección eléctrica
11	HWX20013605	Presostato de alta presión	31	HWX32012210237	Chasis
12	HWX20003603	Presostato baja presión	32	HWX321221176	Caja eléctrica
13	HWX32012210241	Panel ABS superior	33	HWX20003619	Relé
14	HWX20011418	Válvula de 4 vías	34	HWX20003909	Regleta de terminales de 2 conexiones
15	HWX20041446	Filtro (Ø9.7 - Ø3.4)	35	HWX950531145	Tarjeta electrónica PC1000
16	HWX200014153	Válvula Shrader	36	HWX40003901	Regleta de terminales de 5 conexiones
17	HWX34061204	Evaporador	37	HWX200037006	Transformador 230V~/12V~
18	HWX200036005	Detector del caudal	38	HWX20003510	Condensador compresor 60µF
19	HWX20003242	Sonda de temperatura	39	HWX20009909	Capilar
20	HWX20003242	Sonda de temperatura			

## 6. ANEXOS (continuación)

---

### ECP 11

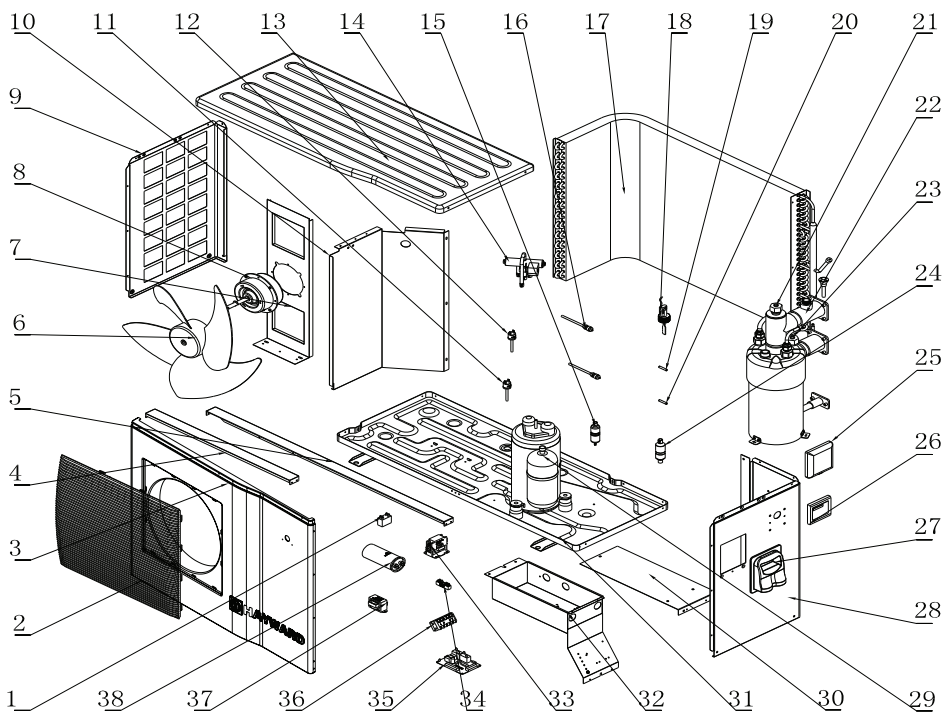

## 6. ANEXOS (continuación)

### ECP 11

Nº	Ref.	Designación	Nº	Ref.	Designación
1	HWX20003501	Condensador ventilador 3µF	21	HWX20003242	Sonda de temperatura
2	HWX35122213	Rejilla	22	HWX32121209	Condensador de titanio/PVC
3	HWX32012210240	Panel ABS delantero	23	HWX20003242	Sonda de temperatura
4	HWX321221175	Tensor delantero	24	HWX20041445	Filter(Φ9.7-Φ4.2)
5	HWX321221018	Tensor trasero	25	HWX20002111	Protección del controlador
6	HWX35002701	Aspa del ventilador	26	HWX950531188	Controlador de 7 segmentos
7	HWX321221174	Soporte del motor	27	HWX32009220054	Mango
8	HWX34043301	Motor del ventilador	28	HWX32012210238	Panel derecho
9	HWX32012210238	Panel de la izquierda	29	HWX20000110134	Compresor
10	HWX321221173	Panel de separación	30	HWX321221019	Panel de protección eléctrica
11	HWX20013605	Presostato de alta presión	31	HWX32012210237	Chasis
12	HWX20003603	Presostato baja presión	32	HWX321221176	Caja eléctrica
13	HWX32012210241	Panel ABS superior	33	HWX20003619	Relé
14	HWX20011418	Válvula de 4 vías	34	HWX20003909	Regleta de terminales de 2 conexiones
15	HWX20041446	Filtro (Ø9.7 - Ø3.4)	35	HWX950531145	Tarjeta electrónica PC1000
16	HWX200014153	Válvula Shrader	36	HWX40003901	Regleta de terminales de 5 conexiones
17	HWX321212002	Evaporador	37	HWX200037006	Transformador 230V~/12V~
18	HWX200036005	Detector del caudal	38	HWX20003505	Condensador compresor 60µF
19	HWX20003242	Sonda de temperatura	39	HWX20009909	Capilar
20	HWX20003242	Sonda de temperatura			

## 6. ANEXOS (continuación)

---

### ECP 13

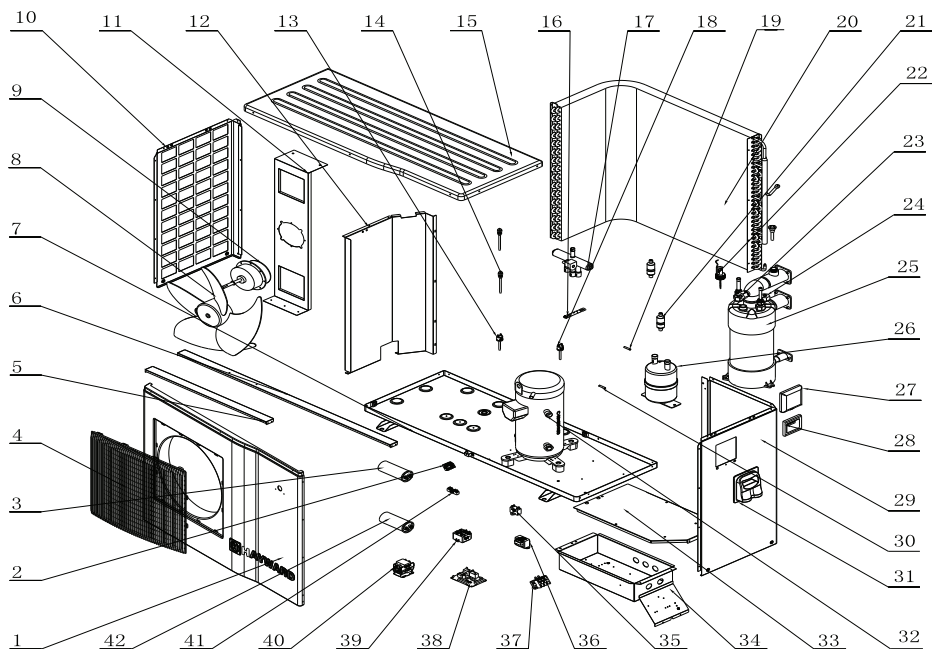



## 6. ANEXOS (continuación)

### ECP 13

Nº	Ref.	Designación	Nº	Ref.	Designación
1	HWX32009210196	Panel ABS delantero	23	HWX20003242	Sonda de temperatura
2	HWX20003933	Regleta de terminales de 3 conexiones	24	HWX20003242	Sonda de temperatura
3	HWX20003524	Condensador arranque CPS 98 $\mu$ F	25	HWX32091206	Condensador de titanio/PVC
4	HWX35122213	Rejilla	26	HWX35001401	Acumulador
5	HWX320921015	Tensor delantero	27	HWX20002111	Protección del controlador
6	HWX320921149	Tensor trasero	28	HWX950531188	Controlador de 7 segmentos
7	HWX32009210193	Chasis	29	HWX32009210194	Panel derecho
8	HWX35002701	Aspa del ventilador	30	HWX20003242	Sonda de temperatura
9	HWX34043301	Motor del ventilador	31	HWX32009220054	Mango
10	HWX320921145	Panel de la izquierda	32	HWX20011170	Compresor
11	HWX320921147	Soporte del motor	33	HWX320921152	Panel de protección eléctrica
12	HWX320921148	Panel de separación	34	HWX320921151	Caja eléctrica
13	HWX20013605	Presostato de alta presión	35	HWX20003501	Condensador ventilador 3 $\mu$ F
14	HWX200014153	Válvula Shrader	36	HWX200037006	Transformador 230V~/12V~
15	HWX32009210197	Panel ABS superior	37	HWX20003920	Regleta de terminales de 3 conexiones
16	HWX20001489	Restrictor	38	HWX950531145	Tarjeta electrónica PC1000
17	HWX20011491	Válvula de 4 vías	39	HWX20003676	Relé
18	HWX20003603	Presostato baja presión	40	HWX200036007	Contactador del compresor
19	HWX20003242	Sonda de temperatura	41	HWX20003909	Regleta de terminales de 2 conexiones
20	HWX351212001	Evaporador	42	HWX20003510	Condensador compresor 60 $\mu$ F
21	HWX20041444	Filtro ( $\varnothing$ 9.7- $\varnothing$ 9.7)	43	HWX20009909	Capilar
22	HWX200036005	Detector del caudal			

## 6. ANEXOS (continuación)

---

### ECP 15

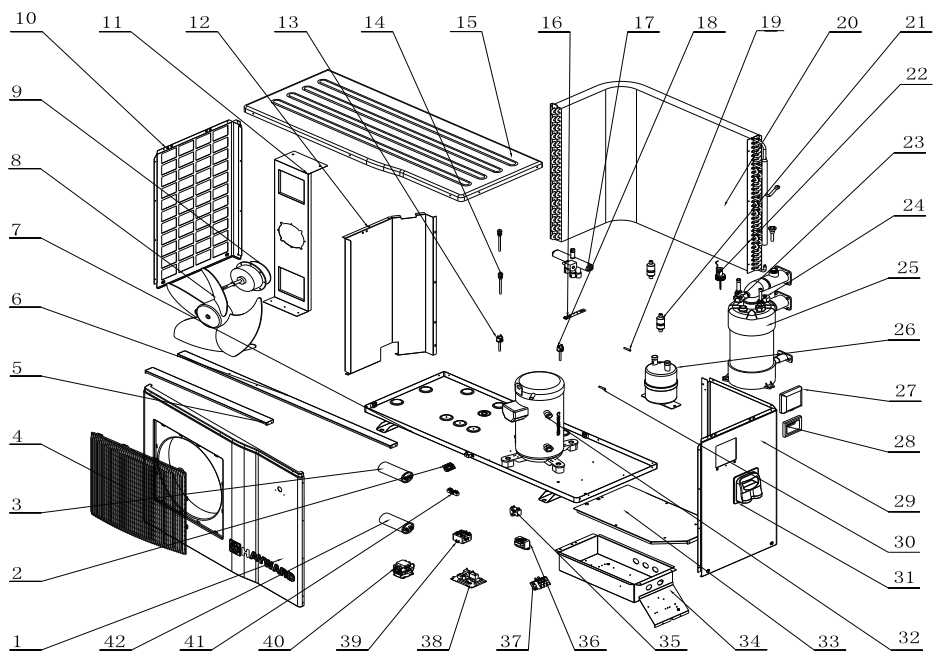

## 6. ANEXOS (continuación)

### ECP 15

Nº	Ref.	Designación	Nº	Ref.	Designación
1	HWX32009210196	Panel ABS delantero	23	HWX20003242	Sonda de temperatura
2	HWX20003933	Regleta de terminales de 3 conexiones	24	HWX20003242	Sonda de temperatura
3	HWX20003524	Condensador arranque CPS 98µF	25	HWX32091206	Condensador de titanio/PVC
4	HWX35122213	Rejilla	26	HWX35001401	Acumulador
5	HWX320921015	Tensor delantero	27	HWX20002111	Protección del controlador
6	HWX320921149	Tensor trasero	28	HWX950531188	Controlador de 7 segmentos
7	HWX32009210193	Chasis	29	HWX32009210194	Panel derecho
8	HWX35002701	Aspa del ventilador	30	HWX20003242	Sonda de temperatura
9	HWX34043301	Motor del ventilador	31	HWX32009220054	Mango
10	HWX320921145	Panel de la izquierda	32	HWX20011169	Compresor
11	HWX320921147	Soporte del motor	33	HWX320921152	Panel de protección eléctrica
12	HWX320921148	Panel de separación	34	HWX320921151	Caja eléctrica
13	HWX20013605	Presostato de alta presión	35	HWX20003501	Condensador ventilador 3µF
14	HWX200014153	Válvula Shrader	36	HWX200037006	Transformador 230V~/12V~
15	HWX32009210197	Panel ABS superior	37	HWX20003920	Regleta de terminales de 3 conexiones
16	HWX20001489	Restrictor	38	HWX950531145	Tarjeta electrónica PC1000
17	HWX20011491	Válvula de 4 vías	39	HWX20003676	Relé
18	HWX20003603	Presostato baja presión	40	HWX200036007	Contactador del compresor
19	HWX20003242	Sonda de temperatura	41	HWX20003909	Regleta de terminales de 2 conexiones
20	HWX351212001	Evaporador	42	HWX20003510	Condensador compresor 60µF
21	HWX20041444	Filtro (Ø9.7-Ø9.7)	43	HWX20009909	Capilar
22	HWX200036005	Detector del caudal			

## 6. ANEXOS (continuación)

### 6.4 Guía de mantenimiento y reparación



*Algunas operaciones debe realizarlas un técnico capacitado.*

Fallo de funcionamiento	Códigos de error	Descripción	Solución
Fallo de la sonda de entrada de agua	P01	El sensor está abierto o presenta un cortocircuito.	Comprobar o sustituir el sensor.
Fallo de la sonda de salida de agua	P02	El sensor está abierto o presenta un cortocircuito.	Comprobar o sustituir el sensor.
Fallo de la sonda de temperatura exterior	P04	El sensor está abierto o presenta un cortocircuito.	Comprobar o sustituir el sensor.
Fallo de la sonda de deshielo	P05	El sensor está abierto o presenta un cortocircuito.	Comprobar o sustituir el sensor.
Protección alta presión	E01	Presión del circuito frigorífico demasiado alta, o caudal de agua demasiado bajo, o evaporador obstruido, o caudal de aire demasiado bajo.	Comprobar el presostato de alta presión y la presión del circuito frigorífico. Comprobar el caudal de agua o de aire. Comprobar el buen funcionamiento del controlador de caudal. Comprobar la apertura de las válvulas de entrada y salida de agua. Comprobar el ajuste de la válvula de derivación.
Protección baja presión	E02	Presión del circuito frigorífico demasiado baja, o caudal de aire demasiado bajo o evaporador obstruido.	Comprobar el presostato de baja presión y la presión del circuito frigorífico para determinar si hay fugas. Limpiar la superficie del evaporador. Comprobar la velocidad de rotación del ventilador. Comprobar la libre circulación del aire a través del evaporador.
Fallo del detector de caudal	E03	Caudal de agua insuficiente o detector en cortocircuito / defectuoso	Comprobar el caudal de agua, la bomba de filtración y el detector de caudal por si presentan fallos.
Diferencia de temperatura excesiva entre el agua de salida y el agua de entrada	E06	Caudal de agua insuficiente, diferencia de presión del agua demasiado baja/alta.	Comprobar el caudal de agua o la obstrucción del sistema.
Protección anticongelante Modo frío	E07	Cantidad de agua de salida insuficiente.	Comprobar el caudal de agua o el sensor de temperatura del agua de salida.
Problema de comunicación	E08	Fallo de funcionamiento del controlador LED o de la conexión PCB.	Comprobar la conexión de los cables.
Protección anticongelante de nivel 1	E19	Temperatura ambiente y del agua de entrada demasiado baja.	Parar la bomba de calor y vaciar el condensador. Riesgo de congelación.
Protección anticongelante de nivel 2	E29	Temperatura ambiente y del agua de entrada aun más baja.	Parar la bomba de calor y vaciar el condensador. Riesgo de congelación.

## **6. ANEXOS (continuación)**

---

### **6.5 Garantía**

#### **CONDICIONES DE GARANTÍA**

Todos los productos HAYWARD están garantizados contra defectos de fabricación y material durante dos años a partir de la fecha de compra. Toda reclamación de garantía debe ir acompañada de una prueba de compra que justifique la fecha. A tal efecto, asegúrese de conservar su factura.

La garantía de HAYWARD se limita a la reparación o sustitución, a elección de HAYWARD, de los productos defectuosos, siempre que se hayan usado en condiciones normales, conforme a las recomendaciones e instrucciones del manual de uso, que no hayan sido objeto de modificación alguna y se hayan utilizado únicamente con componentes y piezas de HAYWARD. Los daños provocados por congelación y agentes químicos no están cubiertos por la garantía.

Todos los demás gastos (transporte, mano de obra, etc.) quedan excluidos de la garantía.

HAYWARD declina toda responsabilidad derivada de daños directos o indirectos causados por una instalación, una conexión o un uso incorrecto del producto.

Para usar la garantía y solicitar la reparación o sustitución de un artículo, póngase en contacto con su distribuidor. No se aceptarán envíos de material a nuestra fábrica sin nuestra aceptación previa por escrito.

Las piezas de desgaste no están cubiertas por la garantía.

# EASY TEMP

## BOMBA DE AQUECIMENTO PARA PISCINAS

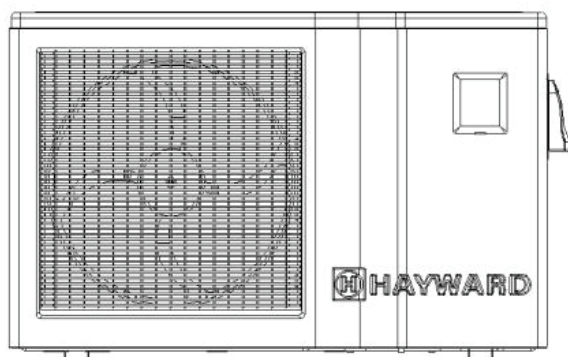

**Manual de instalação e de instruções**

# ÍNDICE

---

<b>1. Prefácio</b>	<b>1</b>
<hr/>	
<b>2. Características técnicas</b>	<b>2</b>
2.1 Dados técnicos da bomba de aquecimento	2
2.2 Gama de funcionamento	3
2.3 Dimensões	4
<hr/>	
<b>3. Instalação e ligações</b>	<b>5</b>
3.1 Esquema de funcionamento	5
3.2 Bomba de aquecimento	5
3.3 Ligação hidráulica	6
3.4 Ligação elétrica	7
3.5 Primeiro arranque	8
3.6 Regulação do caudal de água	10
<hr/>	
<b>4. Interface do utilizador</b>	<b>11</b>
4.1 Apresentação geral	11
4.2 Acerto do relógio	13
4.3 Regulação da função de Temporizador	13
4.4 Escolha do modo de funcionamento: aquecimento ou refrigeração	14
4.5 Regulação e visualização do ponto de referência	15
4.6 Bloqueio e desbloqueio da interface do utilizador	15
<hr/>	
<b>5. Manutenção e Armazenagem</b>	<b>16</b>
5.1 Manutenção	16
5.2 Armazenagem	16
<hr/>	
<b>6. Anexos</b>	<b>17</b>
6.1 Diagramas elétricos	17
6.2 Ligações prioritárias de aquecimento	22
6.3 Diagramas abertos e componentes	23
6.4 Guia de reparação de avarias	33
6.5 Garantia	34

Ler atentamente e guardar para futuras consultas.

O presente documento deve ser entregue ao proprietário da piscina e guardado por este num local seguro.

# 1. PREFÁCIO

---

Os nossos agradecimentos por ter adquirido esta bomba de aquecimento para piscinas Easy Temp. Este produto foi concebido segundo rigorosas normas de fabrico para satisfazer os níveis de qualidade exigidos. O presente Manual inclui todas as informações necessárias relativas à instalação, à eliminação de anomalias e à manutenção. Leia atentamente este Manual antes de abrir o aparelho, ou de realizar qualquer operação de manutenção ao mesmo. O fabricante deste produto não poderá, em circunstância alguma, ser responsabilizado por lesões corporais ou danos materiais na sequência de eventuais erros de instalação, eliminação de anomalias ou intervenção de manutenção sem fundamento. Em qualquer situação, é essencial cumprir as instruções constantes do presente Manual. O aparelho deve ser instalado por pessoal qualificado.

- As reparações devem ser efetuadas por pessoal qualificado.
- Todas as ligações elétricas devem ser efetuadas por um electricista profissional qualificado e segundo as normas em vigor no país de instalação conforme § 3.4.
- A manutenção e as diferentes operações devem ser efetuadas com a frequência e nos momentos recomendados, tal como indicado no presente Manual.
- Utilize exclusivamente componentes de origem.
- Qualquer recomendação que não seja cumprida anula a garantia.
- Esta bomba de aquecimento destina-se a aquecer a água da piscina e mantém uma temperatura constante, não devendo ser utilizada para outros fins.

Depois de ter lido o presente Manual, guarde-o, com vista a futura utilização. Advertências relativas a crianças/pessoas com mobilidade reduzida: este aparelho não se destina a ser utilizado por pessoas (nomeadamente crianças) com capacidades físicas, sensoriais ou intelectuais reduzidas, ou por pessoas que não possuam experiência ou conhecimentos, a menos que estas se encontrem sob vigilância ou tenham recebido instruções sobre a utilização do aparelho por uma pessoa responsável pela sua segurança.

Este produto contém gases com efeito de estufa, fluorados, abrangidos pelo protocolo de Kyoto.

Tipo de refrigerante: R410A

Valor GWP<sup>(1)</sup>: 1975

Podem ser exigidas inspeções periódicas de fugas do refrigerante em função da legislação europeia ou local. Contacte o seu distribuidor local para obter mais informações.

---

(1) Potencial de reaquecimento global



## 2. CARACTERÍSTICAS TÉCNICAS

### 2.1 Dados técnicos da bomba de aquecimento

Modelo	EASY TEMP	ECP 06	ECP 08	ECP 11	ECP 13	ECP 15
Capacidade calorífica*	kW BTU/h	5,5 18785	8 27322	11 37566	13.5 46105	15 51228
Potência elétrica	kW	1,17	1,8	2,43	3	3,13
Corrente de funcionamento*	A	5,19	7,91	11,81	14,5	16
Alimentação elétrica	V Ph/Hz	230 V ~ 1/50 Hz	230 V ~ 1/50 Hz	230 V ~ 1/50 Hz	230 V ~ 1/50 Hz	230 V ~ 1/50 Hz
Calibre do fusível do tipo aM	A	8 aM	10 aM	16 aM	20 aM	20 aM
Curva do disjuntor D	A	8 D	10 D	16 D	20 D	20 D
Número de compressores		1	1	1	1	1
Tipo de compressor		Rotativo	Rotativo	Rotativo	Scroll	Scroll
Número de ventiladores		1	1	1	1	1
Potência do ventilador	W	50	120	120	120	120
Velocidade de rotação do ventilador	RPM	770	850	850	850	850
Direção do ventilador		Horizontal	Horizontal	Horizontal	Horizontal	Horizontal
Nível de pressão sonora (a 1 metro)	dB(A)	47	51	54	56	56
Ligação hidráulica	mm	50	50	50	50	50
Caudal de água	m³/h	2,3	3,0	4,5	5,3	6,6
Perda de carga na água (máx.)	kPa	5,4	8,9	19,2	5,2	39,9
Dimensões líquidas do aparelho (L/l/h)	mm	895/375/545	1035/415/650	1035/415/650	1136/440/870	1136/440/870
Dimensões do aparelho embalado (L/l/h)	mm	970/430/710	1120/480/810	1180/480/810	1230/510/1020	1230/510/1020
Peso líquido/peso do aparelho embalado	kg	45/56	54/68	60/74	95/115	117/128



\* Valor a +/- 5% nas condições seguintes: Temperatura exterior = 24° C (75° F) / HR=62% / Temperatura da piscina = 27° C (80° F)

## 2. CARACTERÍSTICAS TÉCNICAS (continuação)

---

### 2.2 Gama de funcionamento

Utilize a bomba de aquecimento nos intervalos de temperatura e humidade que se seguem para garantir um funcionamento seguro e eficaz.

	Modo de aquecimento 	Modo de arrefecimento 
Temperatura exterior	+2° C ~ +35° C	+7° C ~ +43° C
Temperatura da água	+12° C ~ +40° C	+8° C ~ +40° C
Humidade relativa	< 80%	< 80%
Gama de regulação do ponto de referência	+15° C ~ +40° C	+8° C ~ +35° C



***Se a temperatura ou a humidade não corresponderem a estas condições, podem ativar-se dispositivos de segurança e a bomba de aquecimento pode deixar de funcionar.***

## 2. CARACTERÍSTICAS TÉCNICAS (continuação)

### 2.3 Dimensões

Modelos: ECP06 / ECP08 / ECP11 / ECP13 / ECP15

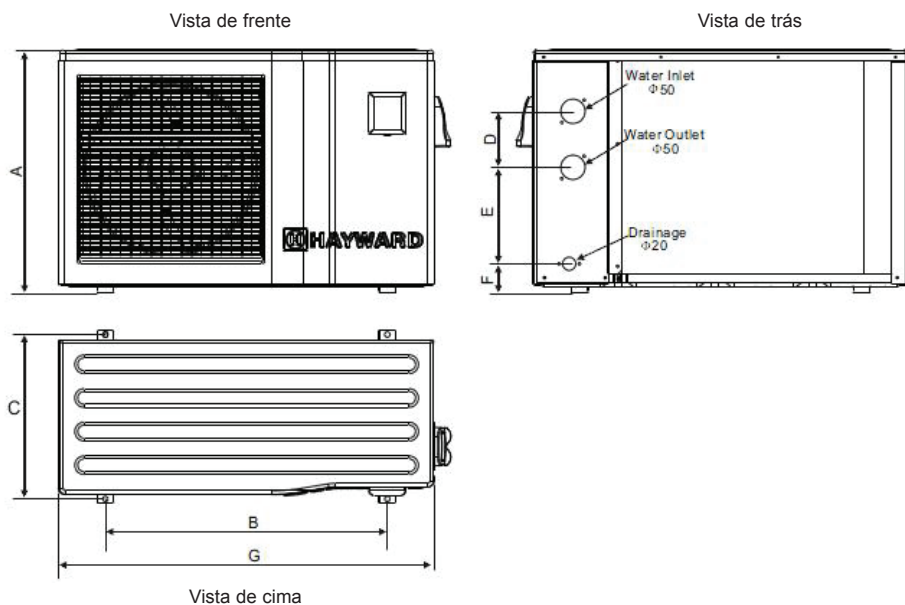

Aparelho: mm

Modelo	ECP06	ECP08 ECP11	ECP13 ECP15
Referência			
<b>A</b>	540	648	866
<b>B</b>	571	755	840
<b>C</b>	400	440	470
<b>D</b>	140	150	150
<b>E</b>	258	258	330
<b>F</b>	66	77	80
<b>G</b>	860	1004	1114

### 3. INSTALAÇÃO E LIGAÇÕES

#### 3.1 Esquema de funcionamento

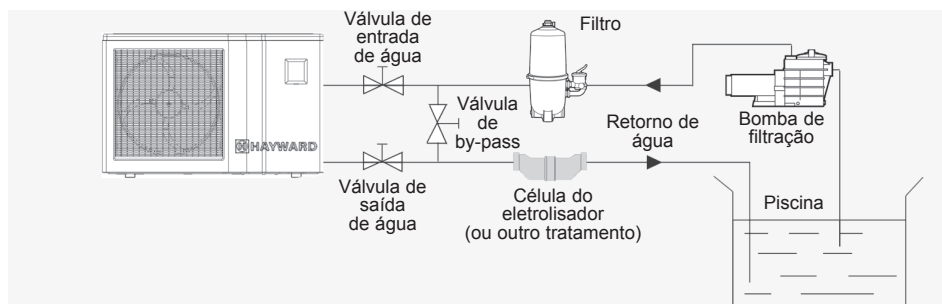

Nota: a bomba de aquecimento é fornecida sem qualquer equipamento de tratamento ou de filtração. Os elementos que constam do esquema são componentes a fornecer pelo instalador.

#### 3.2 Bomba de aquecimento



**Coloque a bomba de aquecimento no exterior e fora de qualquer local técnico fechado.**

**Colocado o aparelho em local abrigado, as distâncias mínimas abaixo indicadas devem ser respeitadas para evitar qualquer risco de recirculação de ar e uma degradação das prestações globais da bomba de aquecimento.**

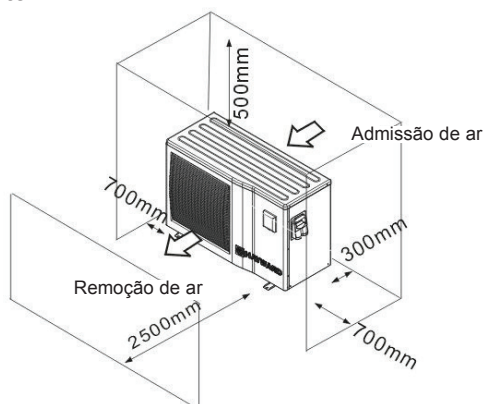

### 3. INSTALAÇÃO E LIGAÇÕES (continuação)

---



**Instale de preferência a bomba de aquecimento numa laje em betão exclusiva ou numa armação de fixação prevista para este efeito e monte a bomba de aquecimento nos blocos amortecedores fornecidos (parafusos e porcas não incluídos).**

**Distância máxima de instalação entre a bomba de aquecimento e a piscina 15 metros.**

**Comprimento total de ida-e-volta das canalizações hidráulicas 30 metros.**

**Isole as canalizações hidráulicas de superfície e enterradas.**

#### 3.3 Ligação hidráulica

A bomba de aquecimento é fornecida com dois conectores de união de 50 mm de diâmetro. Utilize tubo em PVC para a canalização hidráulica com Ø 50 mm. Ligue a entrada de água da bomba de aquecimento à conduta proveniente do grupo de filtração e depois ligue a saída de água da bomba de aquecimento à conduta de água que se dirige para o reservatório (cf. esquema abaixo).

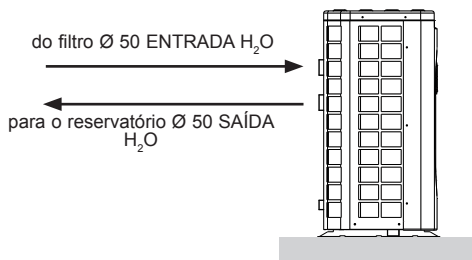

Instale uma válvula denominada “by-pass” entre a entrada e a saída da bomba de aquecimento.



**Se for utilizado um distribuidor automático ou um eletrolisador, a sua instalação deve obrigatoriamente fazer-se depois da bomba de aquecimento com o objetivo de proteger o condensador de titânio contra uma concentração demasiado elevada de produto químico.**



**Tenha o cuidado de instalar corretamente a válvula de by-pass e os conectores de união fornecidos ao nível da entrada e saída de água do aparelho, a fim de simplificar a purga durante o período de inatividade, facilitando o acesso ou a desmontagem para manutenção.**

### 3. INSTALAÇÃO E LIGAÇÕES (continuação)

#### 3.4 Ligação elétrica



**A instalação elétrica e a cablagem deste equipamento devem estar em conformidade com as regras locais de instalação em vigor.**

F	NF C15-100	GB	BS7671:1992
D	DIN VDE 0100-702	EW	EVHS-HD 384-7-702
A	ÖVE 8001-4-702	H	MSZ 2364-702/1994/MSZ 10-553 1/1990
E	UNE 20460-7-702 1993, RECBT ITC-BT-31 2002	M	MSA HD 384-7-702.S2
IRL	Wiring Rules + IS HD 384-7-702	PL	PN-IEC 60364-7-702:1999
I	CEI 64-8/7	CZ	CSN 33 2000 7-702
LUX	384-7.702 S2	SK	STN 33 2000-7-702
NL	NEN 1010-7-702	SLO	SIST HD 384-7-702.S2
P	RSIUEE	TR	TS IEC 60364-7-702



**Verifique se a alimentação elétrica disponível e a frequência da rede correspondem à corrente de funcionamento requerida, tendo em consideração a colocação específica do aparelho e a corrente necessária para alimentar qualquer outro equipamento ligado no mesmo circuito.**

**ECP 06 230 V~ +/- 10 % 50 HZ 1 Fase**

**ECP 08 230 V~ +/- 10 % 50 HZ 1 Fase**

**ECP 11 230 V~ +/- 10 % 50 HZ 1 Fase**

**ECP 13 230 V~ +/- 10 % 50 HZ 1 Fase**

**ECP 15 230 V~ +/- 10 % 50 HZ 1 Fase**

**Respeite o diagrama da cablagem correspondente em anexo.**

**A caixa de ligação encontra-se do lado direito do aparelho. Três conexões destinam-se à alimentação elétrica e duas ao comando da bomba de filtração (Realimentação).**

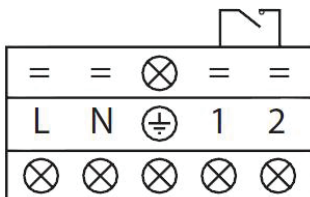

Alimentação geral  
230 V~/50 Hz

Contacto seco livre  
de potencial 7A máx.

### 3. INSTALAÇÃO E LIGAÇÕES (continuação)

---



**A linha de alimentação elétrica deve estar dotada, de forma adequada, de um dispositivo de proteção fusível do tipo alimentação do motor (aM) ou disjuntor de curva D, bem como de um disjuntor diferencial 30mA (ver quadro seguinte).**

Modelos		ECP 06	ECP 08	ECP 11	ECP 13	ECP 15
Alimentação elétrica	V/Ph/ Hz	230 V~ 1/50 Hz	230 V~ 1/50 Hz	230 V~ 1/50 Hz	230 V~ 1/50 Hz	230 V~ 1/50 Hz
Calibre do fusível do tipo aM	A	8 aM	10 aM	16 aM	20 aM	20 aM
Curva do disjuntor D	A	8 D	10 D	16 D	20 D	20 D



**Tenha sempre o cuidado de desligar a alimentação principal antes de abrir a caixa de comando elétrico.**

#### 3.5 Primeiro arranque

Procedimento de arranque – uma vez concluída a instalação, siga e respeite as seguintes etapas:

- 1) Faça rodar o ventilador à mão a fim de verificar se ele gira livremente e se a hélice está fixada corretamente no eixo motor.
- 2) Verifique se o aparelho está corretamente ligado à alimentação principal (consulte o esquema de cablagens em anexo).
- 3) Ative a bomba de filtração.
- 4) Verifique se todas as válvulas de água estão abertas e se a água circula para o aparelho antes de passar ao modo de aquecimento ou de arrefecimento.
- 5) Verifique se o tubo de purga de condensados está corretamente fixado e se não apresenta qualquer obstrução.
- 6) Ative a alimentação elétrica destinada ao aparelho, premindo seguidamente o botão “Marche/Arrêt” (Ligar/Desligar)  no painel de comando.

### 3. INSTALAÇÃO E LIGAÇÕES (continuação)

---

- 7) Verifique se não surge qualquer código de ALARME quando o aparelho está ON (consulte o guia de reparação de avarias).
- 8) Regule o caudal de água com auxílio da válvula de by-pass (consulte os § 3.6 e 2.1), nos termos previstos para cada modelo, de modo a obter uma diferença de temperatura Entrada/Saída de 2° C.
- 9) Após alguns minutos de funcionamento, verifique se o ar que sai do aparelho está refrigerado (entre 5 e 10°).
- 10) Encontrando-se o aparelho em funcionamento, desligue a bomba de filtração. O aparelho deve parar automaticamente e emitir o código de erro E03.
- 11) Deixe o aparelho e a bomba da piscina funcionarem 24 horas por dia até obter a temperatura da água pretendida. Quando a temperatura de entrada da água atinge o valor de referência, o aparelho para. O aparelho arranca de novo automaticamente (desde que a bomba da piscina esteja a funcionar) se a temperatura da piscina for inferior em pelo menos 0,5° C à temperatura de referência.

**Controlador de caudal** - O aparelho está dotado de um controlador de caudal que ativa a bomba de aquecimento desde que a bomba da filtração da piscina esteja em funcionamento, e desativa-a se a bomba da filtração estiver desligada. Ao faltar a água, é emitido o código de alarme E03 no regulador (consulte o § 6.4).

**Temporização** - O aparelho possui uma temporização de 3 minutos, com o objetivo de proteger os componentes do circuito de comando, eliminar qualquer instabilidade no momento de um novo arranque e ainda qualquer interferência ao nível do contactor. Graças a esta temporização, o aparelho arranca de novo automaticamente decorridos cerca de 3 minutos após qualquer corte do circuito de comando. Mesmo um corte de corrente de curta duração ativa a temporização de arranque.



### 3. INSTALAÇÃO E LIGAÇÕES (continuação)

#### 3.6 Regulação do caudal de água

Quando a bomba de aquecimento está em funcionamento e as válvulas de entrada e saída da água estão abertas, ajuste a válvula denominada “by-pass” de forma a obter uma diferença de 2° C entre as temperaturas de entrada e de saída da água (consulte esquema de funcionamento § 3.1). Pode verificar a regulação visualizando as temperaturas de entrada (T02)/saída (T03) diretamente no painel de comando seguindo o procedimento abaixo.

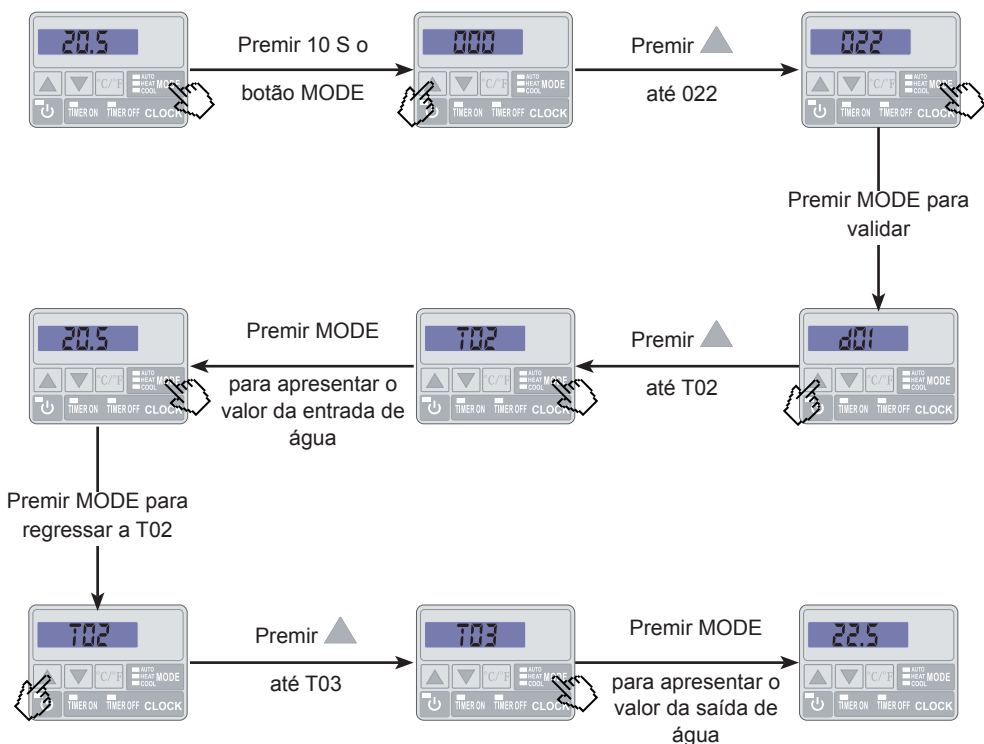

De seguida, regule o seu By-pass para obter uma diferença de 2° C entre T03 e T02 ( $T03 - T02 = \Delta T = 2$ ).

Prima 2 vezes em para sair do menu

Nota: A abertura da válvula denominada “by-pass” provoca uma redução de caudal de que resulta um aumento de  $\Delta T$ .

O fecho da válvula denominada “by-pass” provoca um aumento de caudal de que resulta uma diminuição de  $\Delta T$ .

## 4. INTERFACE DO UTILIZADOR

---

### 4.1 Apresentação geral

A bomba de aquecimento está dotada de um painel de comando eletrónico, ligado eletricamente e pré-regulado de fábrica para o modo de aquecimento.

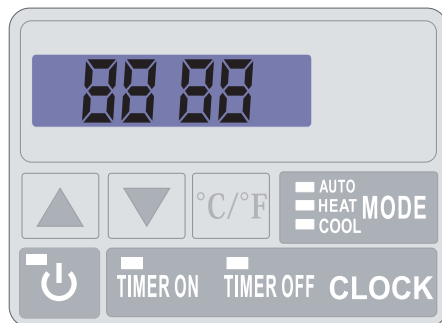

#### Legenda

	Símbolo do Modo de Arrefecimento
	Símbolo do Modo de Aquecimento
	Modo automático
	Acerto da hora e do Temporizador
	Botão de seleção e regulação
	Botão de Ligar/Desligar (Marche/Arrêt) e Retorno /Validação
	Avanço para baixo
	Avanço para cima
	Regulação da hora de ligar
	Regulação da hora de desligar

## 4. INTERFACE DO UTILIZADOR (continuação)

---

### Modo OFF

Quando a bomba de aquecimento está em espera (Modo OFF), a hora, bem como o modo de funcionamento, são indicados no ecrã do regulador.

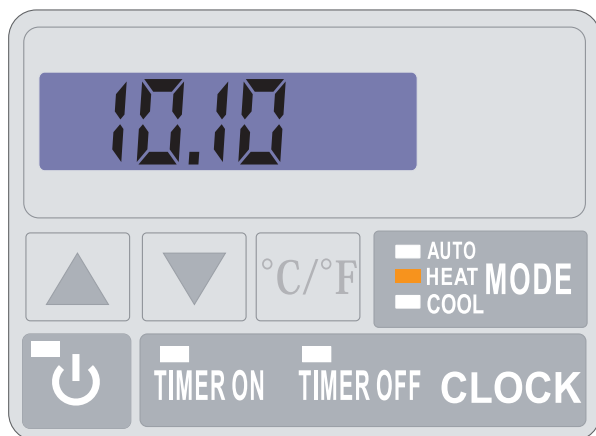

### Modo ON



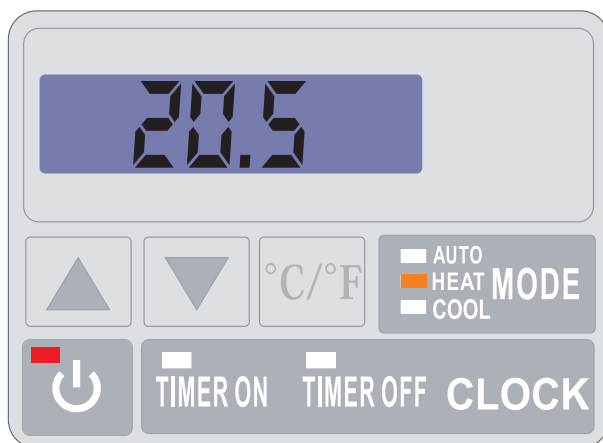

Quando a bomba de aquecimento está em funcionamento ou em regulação (Modo ON), o indicador luminoso do botão de funcionamento tem a luz vermelha acesa e a temperatura de entrada da água é indicada no ecrã.



## 4. INTERFACE DO UTILIZADOR (continuação)

---

### 4.2 Acerto do relógio





O acerto do relógio pode fazer-se em qualquer um dos modos ON ou OFF. Prima "CLOCK"; a indicação fica intermitente; depois, prima "CLOCK"; as horas ficam intermitentes. Acerte as horas com as setas  ou  depois, prima mais uma vez "CLOCK" para selecionar os minutos. Acerte os minutos com as setas  ou . Prima "CLOCK" para validar. O ecrã regressa ao estado anterior.

Nota: a proteção das regulações faz-se com o botão "CLOCK" ou automaticamente se nenhuma tecla for ativada durante 5 segundos.

### 4.3 Regulação da função de Temporizador

A regulação desta função é necessária caso pretenda que a bomba de aquecimento funcione num período mais curto do que o definido pelo relógio da filtração. Deste modo, pode programar um arranque diferido e uma paragem antecipada ou simplesmente interditar um horário de funcionamento (por exemplo, à noite).





#### Programação de Arranque (Timer ON)/Ligar

- 1) Prima "Timer ON"; a hora fica intermitente.
- 2) Prima "Timer ON" para acertar as horas com auxílio dos botões  .
- 3) Prima "Timer ON" para acertar os minutos com auxílio dos botões  .

A proteção das regulações faz-se com o botão "Timer ON"» ou automaticamente se nenhuma tecla for ativada durante 5 segundos.

Uma luz verde indica que o temporizador está ativado.

#### Programação de paragem (Timer OFF)/Desligar

- 1) Prima "Timer OFF"; a hora fica intermitente.
- 2) Prima "Timer OFF" para acertar as horas com auxílio dos botões  .
- 3) Prima "Timer OFF" para acertar os minutos com auxílio dos botões  .



A proteção das regulações faz-se com o botão "Timer OFF" ou automaticamente se nenhuma tecla for ativada durante 5 segundos.

Uma luz vermelha indica que o temporizador está ativado.

## 4. INTERFACE DO UTILIZADOR (continuação)

---

### Supressão dos Temporizadores (Timer ON e OFF)/Desligar e Ligar

- 1) Prima “Timer ON”; “Timer ON” fica intermitente.
- 2) Prima  para suprimir a programação.
- 3) Prima “Timer OFF”; “Timer OFF” fica intermitente.
- 4) Prima  para suprimir a programação.

### 4.4 Escolha do modo de funcionamento: aquecimento, arrefecimento ou automático.

#### Em Modo “OFF” ou “ON”

Prima o botão «MODE» para alternar entre o modo de arrefecimento (luz verde), o modo de aquecimento (luz laranja) e o modo automático (luz vermelha).





## 4. INTERFACE DO UTILIZADOR (continuação)

---



### 4.5 Regulação e visualização do ponto de referência (temperatura da água pretendida)

Em Modo “OFF” e Modo “ON”

Prima os botões  ou  para definir o ponto de referência pretendido. A regulação é feita com uma precisão de 0,5° C.



*É recomendável que a temperatura de 30° C nunca seja ultrapassada, para evitar a alteração dos liners.*

Nota: \_Em funcionamento ou parado, basta premir o botão  ou  para visualizar ou modificar o ponto de referência.

### 4.6 Bloqueio e desbloqueio do ecrã táctil

Prima o botão de Ligar/Desligar  5 s até se ouvir um bip. As teclas ficam inativas.

Para desbloquear, prima  5 s até se ouvir um bip.

As teclas ficam de novo ativas.

## 5. MANUTENÇÃO E ARMAZENAGEM

---

### 5.1 Manutenção

Estas intervenções de manutenção devem ser executadas 1 vez por mês, a fim de garantir a longevidade e o bom funcionamento da bomba de aquecimento.

- Limpe o evaporador com o auxílio de uma escova macia ou um jacto de ar ou de água (**Atenção, nunca utilize um equipamento de limpeza de alta pressão**).
- Verifique o bom escoamento dos condensados.



***Antes de qualquer intervenção de manutenção, a bomba de aquecimento deve ser desligada de qualquer fonte de corrente elétrica. As intervenções de manutenção devem ser efetuadas unicamente por pessoal qualificado e habilitado para manipular os fluidos refrigerantes.***

- Verifique o aperto das ligações hidráulicas e elétricas
- Verifique a estanquicidade hidráulica do condensador.

### 5.2 Armazenagem

- Coloque a bomba de aquecimento no Modo “OFF”.
- Corte a alimentação da bomba de aquecimento.
- Esvazie o condensador com o auxílio do escoamento para evitar qualquer risco de deterioração. (Risco grave de congelamento).
- Feche a válvula de “by-pass” e desparafuse os conectores de união de entrada/saída.
- Retire o máximo de água estagnada residual do condensador com o auxílio de uma pistola de ar.
- Tape a entrada e a saída de água da bomba de aquecimento para evitar a intrusão de objetos estranhos.
- Proteja a bomba de aquecimento com uma cobertura de armazenagem (não fornecida).



***Qualquer dano resultante de uma má armazenagem acarreta a anulação da garantia.***

## 6. ANEXOS

### 6.1 Diagramas elétricos

ECP 06

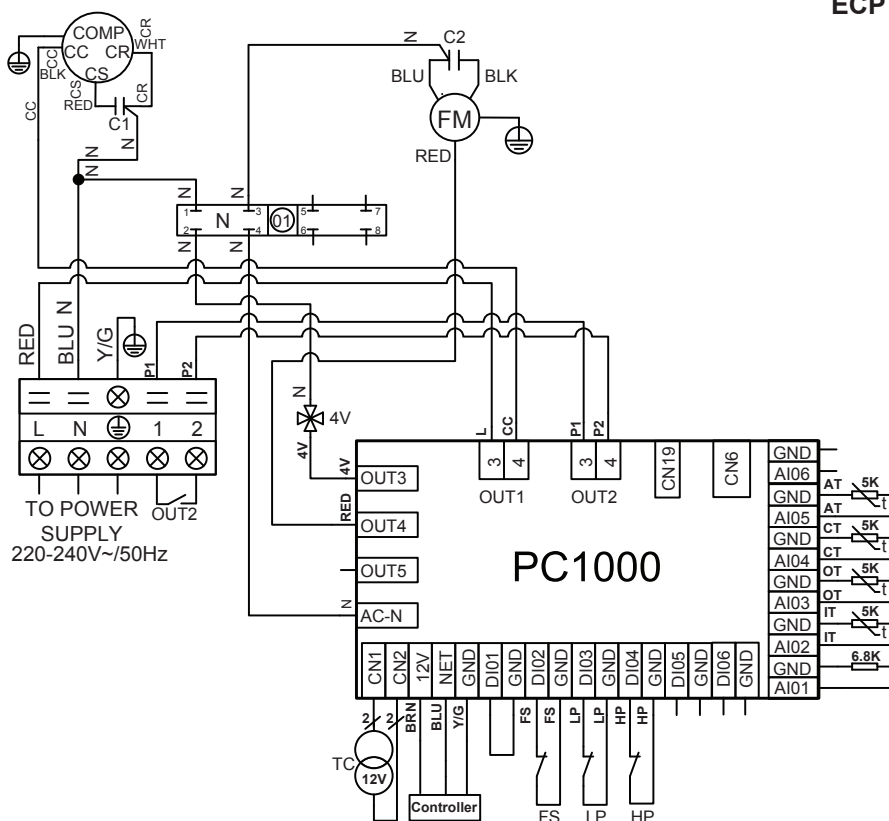

#### OBSERVAÇÕES:

AT: SONDA DE TEMPERATURA DE AR  
 COMP: COMPRESSOR  
 CT: SONDA DE TEMPERATURA DO EVAPORADOR  
 FM: MOTOR DO VENTILADOR  
 FS: DETECTOR DA PRESENÇA DE ÁGUA  
 HP: PRESSÓSTATO DE ALTA PRESSÃO  
 IT: SONDA DA TEMPERATURA DE ENTRADA DE ÁGUA

LP: PRESSÓSTATO DE BAIXA PRESSÃO  
 OT: SONDA DA TEMPERATURA DE SAÍDA DE ÁGUA  
 TC: TRANSFORMADOR 230 V~/12 V~  
 4V: VÁLVULA DE 4 VIAS  
 C1: CONDENSADOR COMPRESSOR  
 C2: CONDENSADOR VENTILADOR  
 OUT2 : CONTACTO SECO LIVRE DE POTENCIAL 7A MÁX



# 6. ANEXOS (continuação)

ECP 08

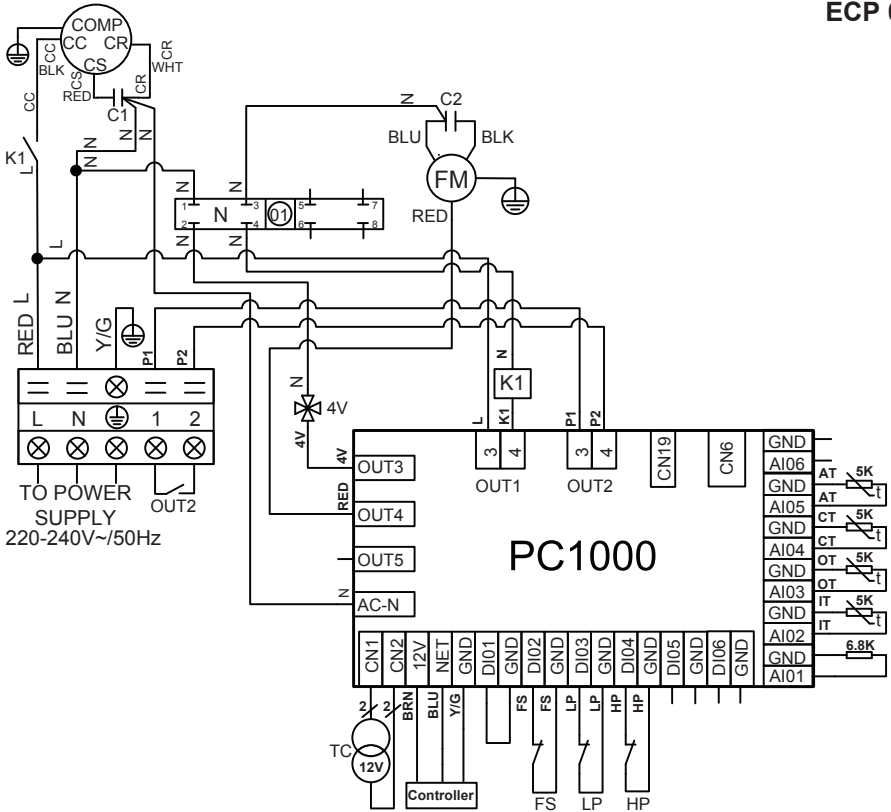

**OBSERVAÇÕES:**

- AT: SONDA DE TEMPERATURA DE AR
- COMP: COMPRESSOR
- CT: SONDA DE TEMPERATURA DO EVAPORADOR
- FM: MOTOR DO VENTILADOR
- FS: DETECTOR DA PRESENÇA DE ÁGUA
- HP: PRESSÓSTATO DE ALTA PRESSÃO
- IT: SONDA DA TEMPERATURA DE ENTRADA DE ÁGUA

- LP: PRESSÓSTATO DE BAIXA PRESSÃO
- OT: SONDA DA TEMPERATURA DE SAÍDA DE ÁGUA
- TC: TRANSFORMADOR 230 V~/12 V~
- 4V: VÁLVULA DE 4 VIAS
- K1: RELÉ DO COMPRESSOR
- C1: CONDENSADOR COMPRESSOR
- C2: CONDENSADOR VENTILADOR
- OUT2 : CONTACTO SECO LIVRE DE POTENCIAL 7A MÁX

## 6. ANEXOS (continuação)

ECP 11

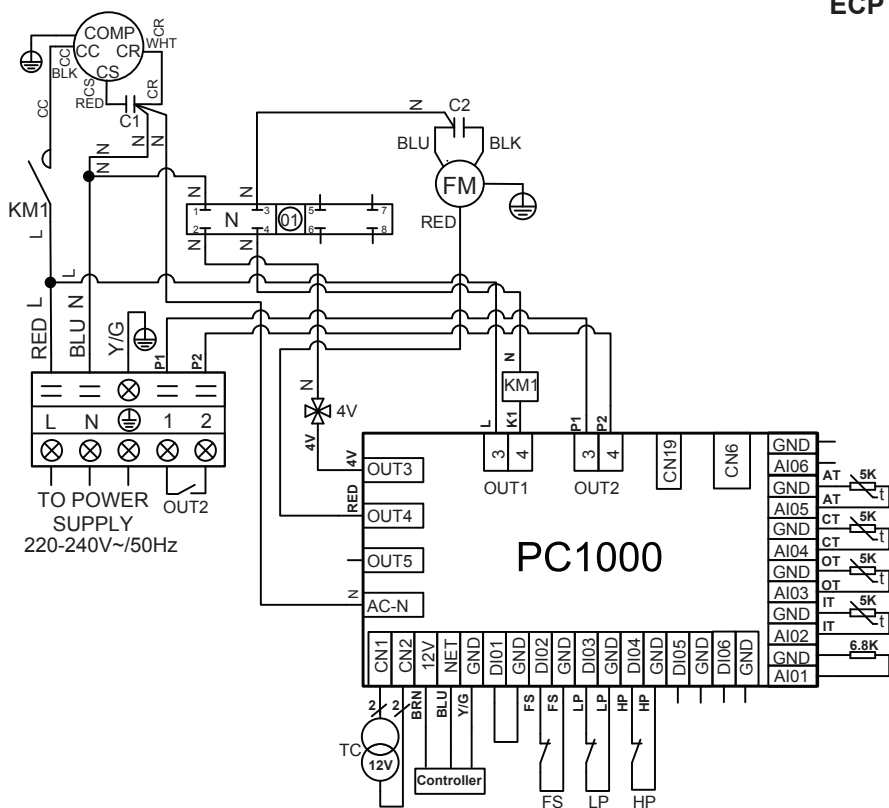

### OBSERVAÇÕES:

AT: SONDA DE TEMPERATURA DE AR  
 COMP: COMPRESSOR  
 CT: SONDA DE TEMPERATURA DO EVAPORADOR  
 FM: MOTOR DO VENTILADOR  
 FS: DETECTOR DA PRESENÇA DE ÁGUA  
 HP: PRESSÓSTATO DE ALTA PRESSÃO  
 IT: SONDA DA TEMPERATURA DE ENTRADA DE ÁGUA

LP: PRESSÓSTATO DE BAIXA PRESSÃO  
 OT: SONDA DA TEMPERATURA DE SAÍDA DE ÁGUA  
 TC: TRANSFORMADOR 230 V~/12 V~  
 4V: VÁLVULA DE 4 VIAS  
 KM1: CONTACTOR DE POTÊNCIA DO COMPRESSOR  
 C1: CONDENSADOR DO COMPRESSOR  
 C2: CONDENSADOR DO VENTILADOR  
 OUT2 : CONTACTO SECO LIVRE DE POTENCIAL 7A MÁX

## 6. ANEXOS (continuação)

ECP 13

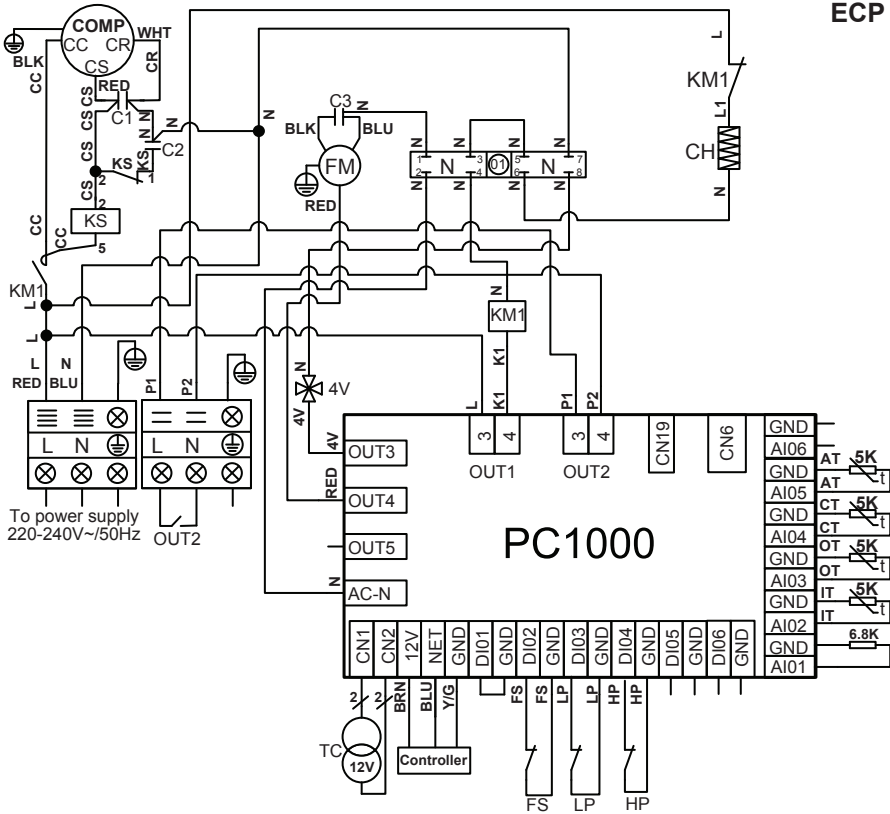

### OBSERVAÇÕES:

AT: SONDA DE TEMPERATURA DE AR  
 COMP: COMPRESSOR  
 CH: RESISTÊNCIA DE CÂRTER  
 CT: SONDA DE TEMPERATURA DO EVAPORADOR  
 FM: MOTOR DO VENTILADOR  
 FS: DETETOR DA PRESENÇA DE ÁGUA  
 HP: PRESSÓSTATO DE ALTA PRESSÃO  
 IT: SONDA DA TEMPERATURA DE ENTRADA DE ÁGUA

KS: BOBINA DO RELÉ DE ARRANQUE DO COMPRESSOR  
 LP: PRESSÓSTATO DE BAIXA PRESSÃO  
 OT: SONDA DA TEMPERATURA DE SAÍDA DE ÁGUA  
 TC: TRANSFORMADOR 230 V~/12 V~  
 4V: VÁLVULA DE 4 VIAS  
 KM1: CONTACTOR DE POTÊNCIA DO COMPRESSOR  
 C1: CONDENSADOR PERMANENTE  
 C2: CONDENSADOR DE ARRANQUE  
 OUT2 : CONTACTO SECO LIVRE DE POTENCIAL 7A MÁX

## 6. ANEXOS (continuação)

ECP 15

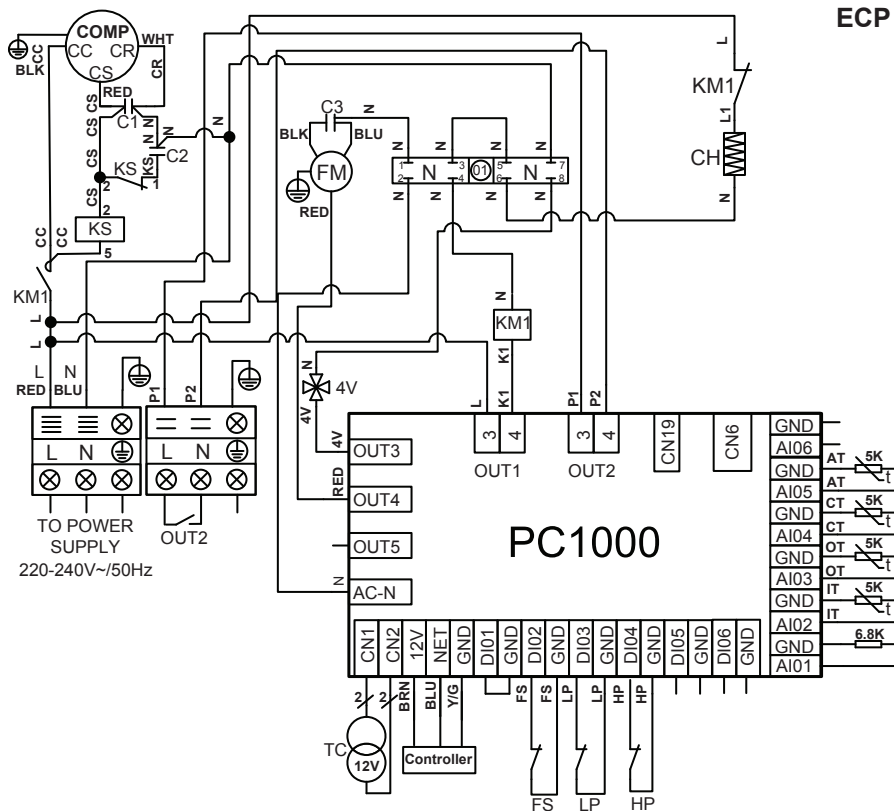

### OBSERVAÇÕES:

AT: SONDA DE TEMPERATURA DE AR  
 COMP: COMPRESSOR  
 CH: RESISTÊNCIA DE CÂRTER  
 CT: SONDA DE TEMPERATURA DO EVAPORADOR  
 FM: MOTOR DO VENTILADOR  
 FS: DETECTOR DA PRESENÇA DE ÁGUA  
 HP: PRESSÓSTATO DE ALTA PRESSÃO  
 IT: SONDA DA TEMPERATURA DE ENTRADA DE ÁGUA

KS: BOBINA DO RELÉ DE ARRANQUE DO COMPRESSOR  
 LP: PRESSÓSTATO DE BAIXA PRESSÃO  
 OT: SONDA DA TEMPERATURA DE SAÍDA DE ÁGUA  
 TC: TRANSFORMADOR 230 V~12 V~  
 4V: VÁLVULA DE 4 VIAS  
 KM1: CONTACTOR DE POTÊNCIA DO COMPRESSOR  
 C1: CONDENSADOR PERMANENTE  
 C2: CONDENSADOR DE ARRANQUE  
 OUT2 : CONTACTO SECO LIVRE DE POTENCIAL 7A MÁX

## 6. ANEXOS (continuação)

### 6.2 Ligações prioritárias do aquecimento Bomba monofásica

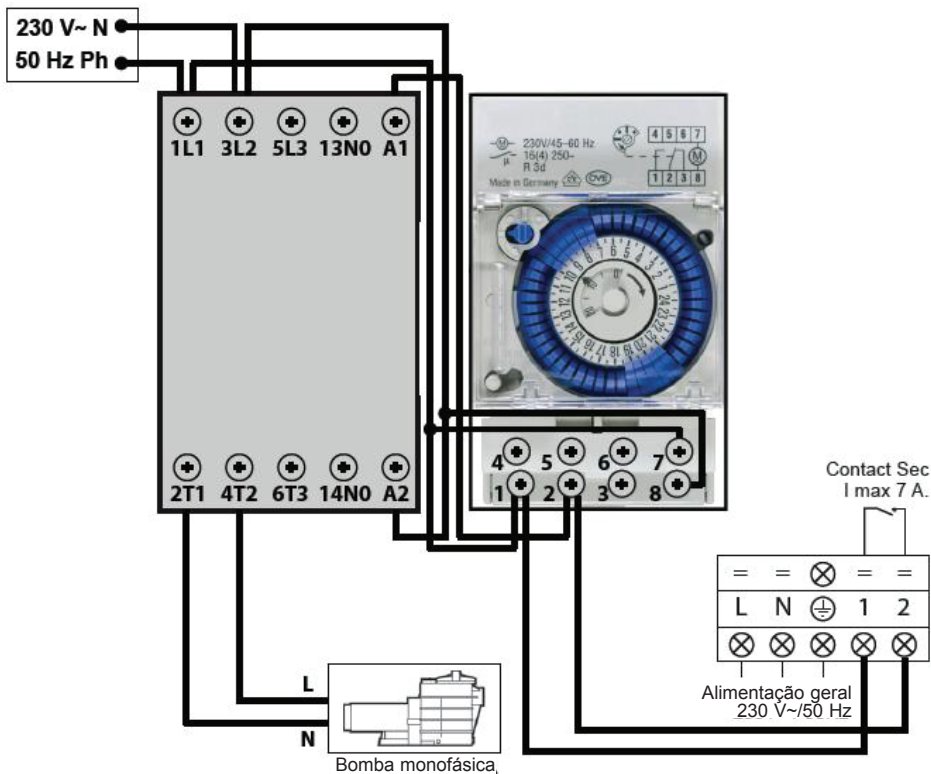

Os terminais 1 e 2 emitem um contacto seco livre de potencial, sem polaridade de 230 V~ / 50 Hz. Cablar os terminais 1 e 2 respeitando a cablagem indicada acima, a fim de controlar o funcionamento da bomba de filtração por ciclo de 2 minutos todas as horas se a temperatura da bacia for inferior ao ponto recomendado.

 Nunca conecte a alimentação da bomba de filtração directamente sobre os terminais 1 e 2.



## 6. ANEXOS (continuação)

### 6.3 Diagramas abertos e componentes

ECP 06

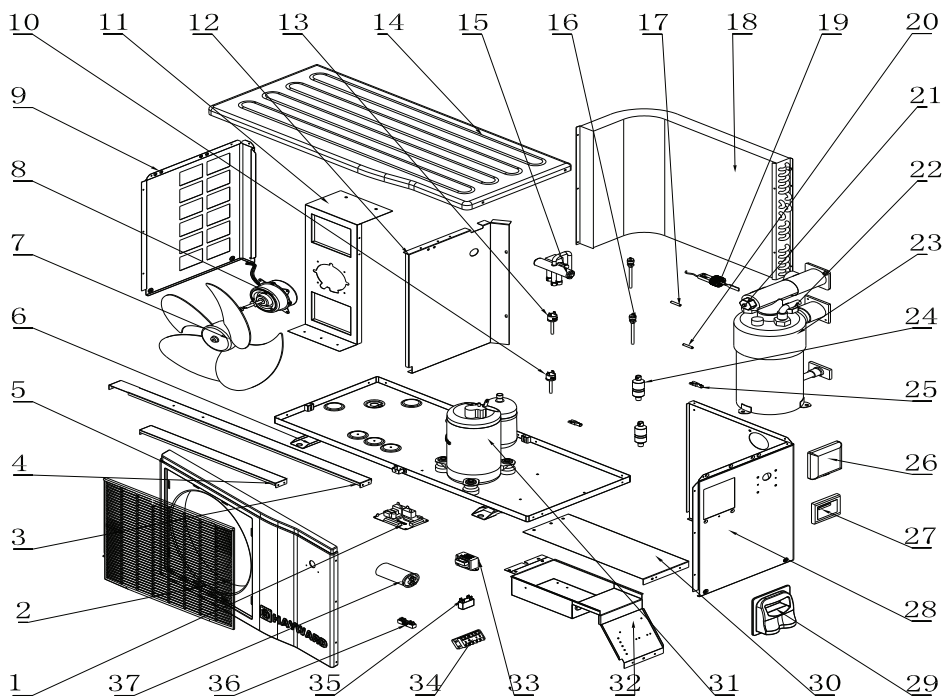

## 6. ANEXOS (continuação)

---

### ECP 06

Rep	Ref. <sup>a</sup>	Designação	Rep	Ref. <sup>a</sup>	Designação
1	HWX950531145	Placa eletrónica PC1000	20	HWX20003242	Sonda de temperatura
2	HWX35252208	Grelha	21	HWX20003242	Sonda de temperatura
3	HWX322521062	Esticador traseiro	22	HWX20003242	Sonda de temperatura
4	HWX322521063	Esticador dianteiro	23	HWX35251210	Condensador Titânio/ PVC
5	HWX32025210084	Painel ABS dianteiro	24	HWX20041444	Filtro (Ø9,7-Ø9,7)
6	HWX32025210081	Chassis	25	HWX200014068	Conector capilar
7	HWX34012701	Pá do ventilador	26	HWX20002111	Proteção do controlador
8	HWX34013301	Motor do ventilador	27	HWX950531188	Controlador 7 segmentos
9	HWX32025210083	Painel esquerdo	28	HWX32025210082	Painel direito
10	HWX20003603	Pressóstato de baixa pressão	29	HWX32009220054	Pega
11	HWX322521061	Suporte do motor	30	HWX322521064	Painel de proteção elétrica
12	HWX322521059	Painel de separação	31	HWX200011006	Compressor
13	HWX20013605	Pressóstato de alta pressão	32	HWX322521006	Quadro elétrico
14	HWX32025210085	Painel ABS superior	33	HWX200037006	Transformador 230 V~/12 V~
15	HWX20011418	Válvula de 4 vias	34	HWX40003901	Bloco de terminais elétricos 5 conexões
16	HWX200014153	Válvula Shrader	35	HWX20003506	Condensador ventilador 2µF
17	HWX20003242	Sonda de temperatura	36	HWX20003909	Bloco de terminais 2 conexões
18	HWX40001230	Evaporador	37	HWX20003504	Condensador compressor 35µF
19	HWX200036005	Detetor de caudal	38	HWX20009910	Capilar

## 6. ANEXOS (continuação)

### ECP 08

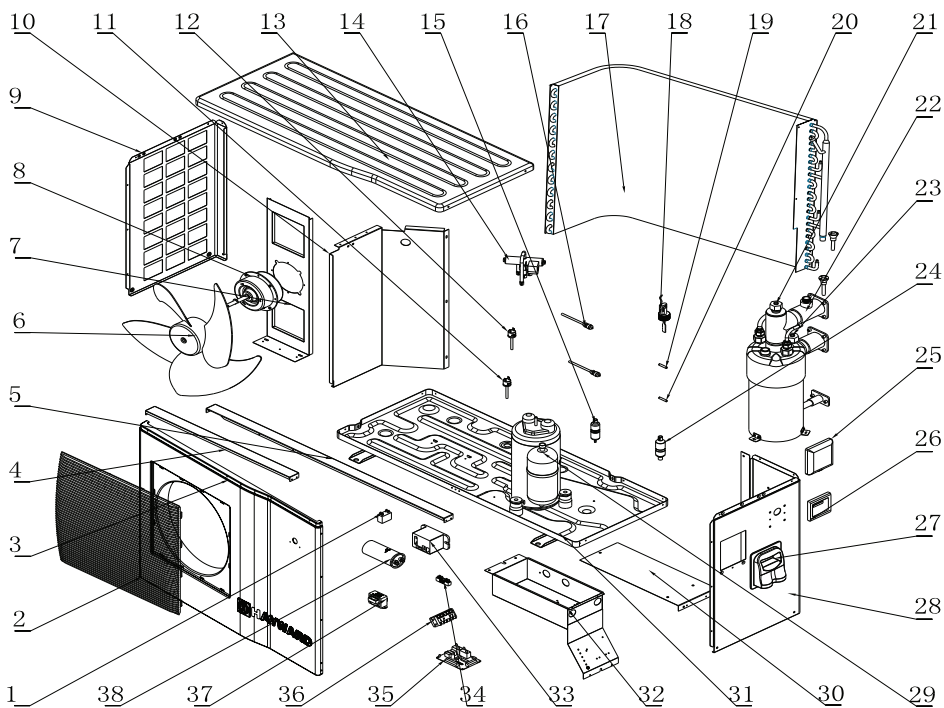



## 6. ANEXOS (continuação)

### ECP 08

Rep	Ref. <sup>a</sup>	Designação	Rep	Ref. <sup>a</sup>	Designação
1	HWX20003501	Condensador ventilador 3µF	21	HWX20003242	Sonda de temperatura
2	HWX35122213	Grelha	22	HWX32081205	Condensador Titânio/PVC
3	HWX32012210240	Painel ABS dianteiro	23	HWX20003242	Sonda de temperatura
4	HWX321221175	Esticador dianteiro	24	HWX20041445	Filter(Φ9.7-Φ4.2)
5	HWX321221018	Esticador traseiro	25	HWX20002111	Proteção do controlador
6	HWX35002701	Pá do ventilador	26	HWX950531188	Controlador 7 segmentos
7	HWX321221174	Suporte do motor	27	HWX32009220054	Pega
8	HWX34043301	Motor do ventilador	28	HWX32012210238	Painel direito
9	HWX32012210238	Painel esquerdo	29	HWX200011135	Compressor
10	HWX321221173	Painel de separação	30	HWX321221019	Painel de proteção elétrica
11	HWX20013605	Pressóstato de alta pressão	31	HWX32012210237	Chassis
12	HWX20003603	Pressóstato de baixa pressão	32	HWX321221176	Quadro elétrico
13	HWX32012210241	Painel ABS superior	33	HWX20003619	Relés
14	HWX20011418	Válvula de 4 vias	34	HWX20003909	Bloco de terminais 2 conexões
15	HWX20041446	Filtro (Ø9,7 - Ø3,4)	35	HWX950531145	Placa eletrónica PC1000
16	HWX200014153	Válvula Shrader	36	HWX40003901	Bloco de terminais elétricos 5 conexões
17	HWX34061204	Evaporador	37	HWX200037006	Transformador 230 V~/12 V~
18	HWX200036005	Detetor de caudal	38	HWX20003510	Condensador compressor 60µF
19	HWX20003242	Sonda de temperatura	39	HWX20009909	Capilar
20	HWX20003242	Sonda de temperatura			

## 6. ANEXOS (continuação)

---

### ECP 11

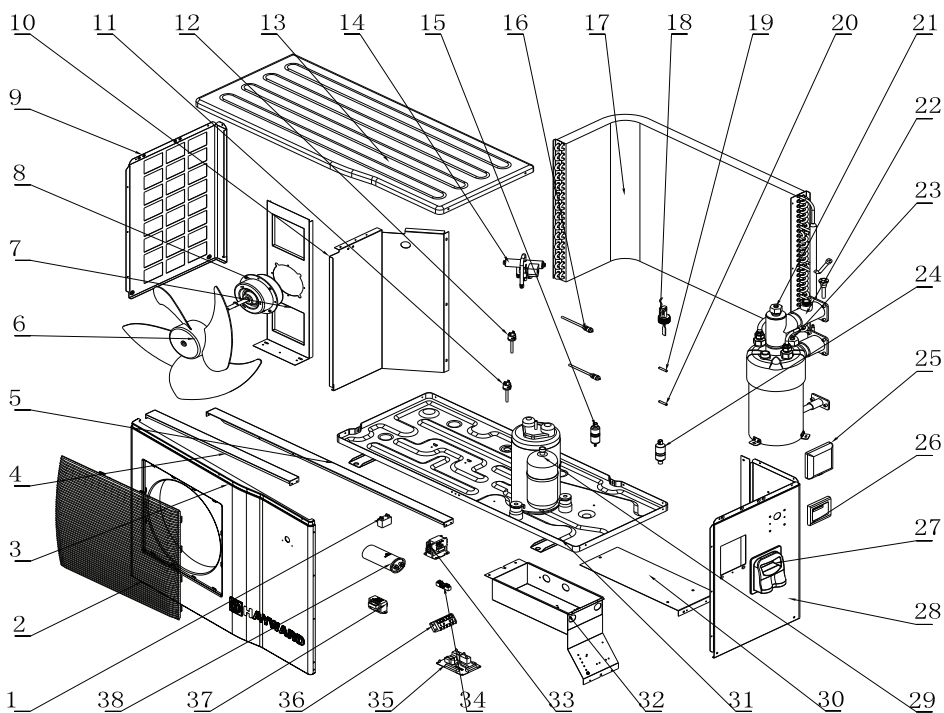

## 6. ANEXOS (continuação)

### ECP 11

Rep	Ref. <sup>a</sup>	Designação	Rep	Ref. <sup>a</sup>	Designação
1	HWX20003501	Condensador ventilador 3 $\mu$ F	21	HWX20003242	Sonda de temperatura
2	HWX35122213	Grelha	22	HWX32121209	Condensador Titânio/PVC
3	HWX32012210240	Painel ABS dianteiro	23	HWX20003242	Sonda de temperatura
4	HWX321221175	Esticador dianteiro	24	HWX20041445	Filter( $\Phi$ 9.7- $\Phi$ 4.2)
5	HWX321221018	Esticador traseiro	25	HWX20002111	Proteção do controlador
6	HWX35002701	Pá do ventilador	26	HWX950531188	Controlador 7 segmentos
7	HWX321221174	Suporte do motor	27	HWX32009220054	Pega
8	HWX34043301	Motor do ventilador	28	HWX32012210238	Painel direito
9	HWX32012210238	Painel esquerdo	29	HWX200011134	Compressor
10	HWX321221173	Painel de separação	30	HWX321221019	Painel de proteção elétrica
11	HWX20013605	Pressóstato de alta pressão	31	HWX32012210237	Chassis
12	HWX20003603	Pressóstato de baixa pressão	32	HWX321221176	Quadro elétrico
13	HWX32012210241	Painel ABS superior	33	HWX20003619	Relés
14	HWX20011418	Válvula de 4 vias	34	HWX20003909	Bloco de terminais 2 conexões
15	HWX20041446	Filtro ( $\Phi$ 9,7 - $\Phi$ 3,4)	35	HWX950531145	Placa eletrônica PC1000
16	HWX200014153	Válvula Shrader	36	HWX40003901	Bloco de terminais elétricos 5 conexões
17	HWX321212002	Evaporador	37	HWX200037006	Transformador 230 V~/12 V~
18	HWX200036005	Detetor de caudal	38	HWX20003505	Condensador compressor 60 $\mu$ F
19	HWX20003242	Sonda de temperatura	39	HWX20009909	Capilar
20	HWX20003242	Sonda de temperatura			

## 6. ANEXOS (continuação)

---

### ECP 13

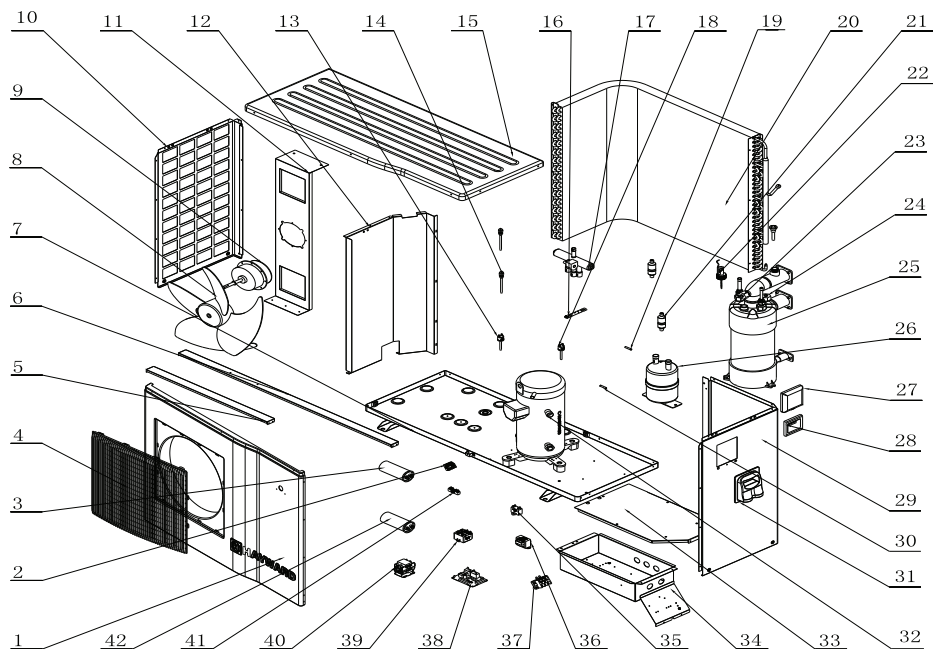

## 6. ANEXOS (continuação)

### ECP 13

Rep	Ref. <sup>a</sup>	Designação	Rep	Ref. <sup>a</sup>	Designação
1	HWX32009210196	Painel ABS dianteiro	23	HWX20003242	Sonda de temperatura
2	HWX20003933	Bloco de terminais 3 conexões	24	HWX20003242	Sonda de temperatura
3	HWX20003524	Condensador de arranque CPS 98µF	25	HWX32091206	Condensador Titânio/PVC
4	HWX35122213	Grelha	26	HWX35001401	Acumulador
5	HWX320921015	Esticador dianteiro	27	HWX20002111	Proteção do controlado
6	HWX320921149	Esticador traseiro	28	HWX950531188	Controlador 7 segmentos
7	HWX32009210193	Chassis	29	HWX32009210194	Painel direito
8	HWX35002701	Pá do ventilador	30	HWX20003242	Sonda de temperatura
9	HWX34043301	Motor do ventilador	31	HWX32009220054	Pega
10	HWX32009210195	Painel esquerdo	32	HWX20011170	Compressor
11	HWX320921147	Suporte do motor	33	HWX320921152	Painel de proteção elétrica
12	HWX320921148	Painel de separação	34	HWX320921151	Quadro elétrico
13	HWX20013605	Pressóstato de alta pressão	35	HWX20003501	Condensador ventilador 3µF
14	HWX200014153	Válvula Shrader	36	HWX200037006	Transformador 230 V~/12 V~
15	HWX320922038	Painel ABS superior	37	HWX20003920	Bloco de terminais 3 conexões
16	HWX20001489	Restritor	38	HWX950531145	Placa eletrónica PC1000
17	HWX20011491	Válvula de 4 vias	39	HWX20003676	Relés
18	HWX20003603	Pressóstato de baixa pressão	40	HWX200036007	Contactador do compressor
19	HWX20003242	Sonda de temperatura	41	HWX20003909	Bloco de terminais 2 conexões
20	HWX351212001	Evaporador	42	HWX20003510	Condensador compressor 60µF
21	HWX20041444	Filtro (Ø9,7-Ø9,7)	43	HWX20009909	Capilar
22	HWX200036005	Detetor de caudal			

## 6. ANEXOS (continuação)

---

ECP 15

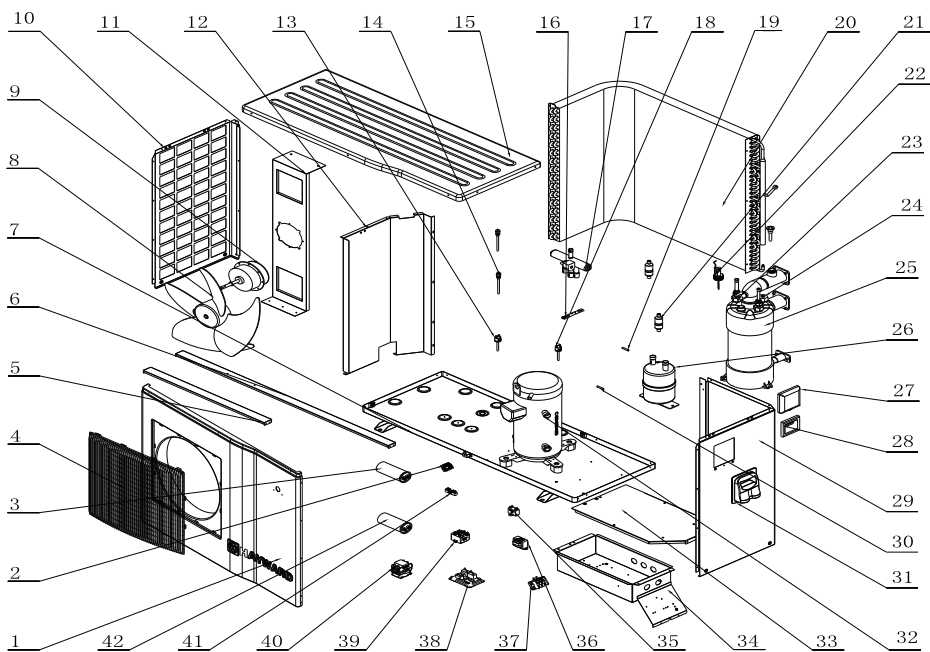

## 6. ANEXOS (continuação)

### ECP 15

Rep	Ref. <sup>a</sup>	Designação	Rep	Ref. <sup>a</sup>	Designação
1	HWX32009210196	Painel ABS dianteiro	23	HWX20003242	Sonda de temperatura
2	HWX20003933	Bloco de terminais 3 conexões	24	HWX20003242	Sonda de temperatura
3	HWX20003524	Condensador de arranque CPS 98µF	25	HWX32091206	Condensador Titânio/PVC
4	HWX35122213	Grelha	26	HWX35001401	Acumulador
5	HWX320921015	Esticador dianteiro	27	HWX20002111	Proteção do controlado
6	HWX320921149	Esticador traseiro	28	HWX950531188	Controlador 7 segmentos
7	HWX32009210193	Chassis	29	HWX32009210194	Painel direito
8	HWX35002701	Pá do ventilador	30	HWX20003242	Sonda de temperatura
9	HWX34043301	Motor do ventilador	31	HWX32009220054	Pega
10	HWX32009210195	Painel esquerdo	32	HWX20011169	Compressor
11	HWX320921147	Suporte do motor	33	HWX320921152	Painel de proteção elétrica
12	HWX320921148	Painel de separação	34	HWX320921151	Quadro elétrico
13	HWX20013605	Pressóstato de alta pressão	35	HWX20003501	Condensador ventilador 3µF
14	HWX200014153	Válvula Shrader	36	HWX200037006	Transformador 230 V~/12 V~
15	HWX320922038	Painel ABS superior	37	HWX20003920	Bloco de terminais 3 conexões
16	HWX20001489	Restritor	38	HWX950531145	Placa eletrónica PC1000
17	HWX20011491	Válvula de 4 vias	39	HWX20003676	Relés
18	HWX20003603	Pressóstato de baixa pressão	40	HWX200036007	Contactador do compressor
19	HWX20003242	Sonda de temperatura	41	HWX20003909	Bloco de terminais 2 conexões
20	HWX351212001	Evaporador	42	HWX20003510	Condensador compressor 60µF
21	HWX20041444	Filtro (Ø9,7-Ø9,7)	43	HWX20009909	Capilar
22	HWX200036005	Detetor de caudal			

## 6. ANEXOS (continuação)

### 6.4 Guia de reparação de avarias



*Algumas intervenções devem ser efetuadas por um técnico habilitado.*

Anomalia	Códigos de erro	Descrição	Solução
Avaria da sonda de entrada de água	P01	O sensor está aberto ou apresenta um curto-circuito.	Verificar ou substituir o sensor.
Avaria sonda de saída de água	P02	O sensor está aberto ou apresenta um curto-circuito.	Verificar ou substituir o sensor.
Avaria da sonda de temperatura exterior	P04	O sensor está aberto ou apresenta um curto-circuito.	Verificar ou substituir o sensor.
Avaria da sonda de descongelamento	P05	O sensor está aberto ou apresenta um curto-circuito.	Verificar ou substituir o sensor.
Proteção de alta pressão	E01	Pressão do circuito frigorífico demasiado elevada, ou caudal de água demasiado baixo, ou evaporador obstruído, ou caudal de ar demasiado baixo.	Verificar o pressóstato de alta pressão e a pressão do circuito frigorífico. Verificar o caudal de água ou de ar. Verificar o bom funcionamento do controlador de caudal. Verificar a abertura das válvulas de entrada/saída de água. Verificar a regulação do by-pass.
Proteção de baixa pressão	E02	Pressão do circuito frigorífico demasiado baixa, ou caudal de ar demasiado baixa ou evaporador obstruído.	Verificar o pressóstato de baixa pressão e a pressão do circuito frigorífico para avaliar se há alguma fuga. Limpar a superfície do evaporador. Verificar a velocidade de rotação do ventilador. Verificar a livre circulação do ar que atravessa o evaporador.
Avaria do detetor de caudal	E03	Caudal de água insuficiente ou detetor em curto-circuito ou defeituoso	Verificar o caudal de água, verificar a bomba de filtração e o detetor de caudal para ver se apresentam eventuais anomalias.
Diferença de temperatura demasiado grande entre a água à saída e a água à entrada	E06	Caudal volumétrico de água insuficiente, diferença de pressão de água demasiado baixa/demasiado elevada.	Verificar o caudal de água ou a obstrução do sistema.
Proteção anticongelamento Modo frio	E07	Quantidade de água que sai demasiado baixa.	Verificar o caudal de água, ou o sensor de temperatura da água à saída.
Problema de comunicação	E08	Anomalia do controlador LED ou da conexão PCB.	Verificar a ligação dos cabos.
Proteção anticongelamento de nível 1	E19	Temperatura ambiente e da água à entrada demasiado baixa.	Desligar a bomba de aquecimento e esvaziar o condensador. Risco de congelamento.
Proteção anticongelamento de nível 2	E29	Temperatura ambiente e da água à entrada ainda mais baixa.	Desligar a bomba de aquecimento e esvaziar o condensador. Risco de congelamento.



## 6. ANEXOS (continuação)

---

### 6.5 Garantia

#### CONDIÇÕES DA GARANTIA

Todos os produtos HAYWARD estão garantidos contra qualquer defeito de fabrico ou de material pelo período de dois anos a contar da data de compra. Todos os pedidos de garantia devem ser acompanhados pelo comprovativo de compra onde conste a respetiva data. Por este motivo, recomendamos que a fatura seja guardada.

A garantia HAYWARD está limitada à reparação ou substituição, à escolha de HAYWARD, dos produtos defeituosos na condição de estes terem tido uma utilização normal, em conformidade com o disposto no respetivo manual de utilização, de o produto não ter sofrido qualquer tipo de alteração e ter sido utilizado exclusivamente com componentes e peças HAYWARD. Os danos provocados por congelamento e ataques de agentes químicos não estão abrangidos pela garantia.

Todos os restantes custos (transporte, mão-de-obra...) estão excluídos da garantia.

HAYWARD não poderá ser responsabilizada por qualquer dano direto ou indireto proveniente de incorreções de instalação, ligação ou funcionamento de um aparelho.

Para ativar uma garantia e solicitar a reparação ou substituição de um artigo, dirija-se ao seu revendedor. Nenhuma devolução de material para a nossa fábrica será aceite sem o nosso acordo prévio por escrito.

Os componentes de desgaste não estão abrangidos pela garantia.

# EASY TEMP

HEIZPUMPENANLAGE FÜR EIN SCHWIMMBECKEN

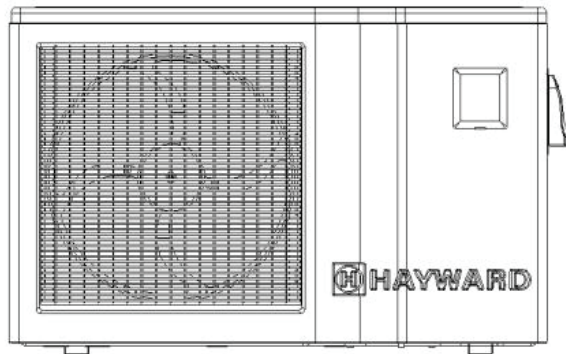

Einbau- & Anleitungshandbuch

# ZUSAMMENFASSUNG

---

<b>1. Vorwort</b>	<b>1</b>
<hr/>	
<b>2. Technische Merkmale</b>	<b>2</b>
2.1 Technische Daten der Wärmepumpe	2
2.2 Funktionsbereiche	3
2.3 Abmessungen	4
<hr/>	
<b>3. Montage und Anschlüsse</b>	<b>5</b>
3.1 Grunds Schaltbild	5
3.2 Wärmepumpe	5
3.3 Hydraulikverbindung	6
3.4 Stromanschluss	7
3.5 Erste Inbetriebnahme	8
3.6 Regulierung der Wasserausgabe	10
<hr/>	
<b>4. Schnittstelle Benutzer</b>	<b>11</b>
4.1 Allgemeine Darstellung	11
4.2 Einstellung der Uhr	13
4.3 Einstellung der Timer-Funktion	13
4.4 Auswahl der Funktions-Art: Heizen oder Kühlen	14
4.5 Einstellen und Anzeigen des vorgegebenen Wertes	15
4.6 Blockieren und Freigabe der Benutzer-Schnittstelle	15
<hr/>	
<b>5. Wartung und Vorbereitung auf die Produktsicherung für den Winter</b>	<b>16</b>
5.1 Wartung	16
5.2 Vorbereitung auf den Winter	16
<hr/>	
<b>6. Anhänge</b>	<b>17</b>
6.1 Stromschalt-Schemata	17
6.2 Anschlüsse mit Vorrang für die Heizung	22
6.3 Perspektivische Darstellungen und Bestandteile	23
6.4 Anleitung zur Fehlerbeseitigung	33
6.5 Garantie	34

sicheren Ort aufbewahrt werden.

Sorgfältig durchlesen und zwecks späterer Lektüre aufbewahren.

Dieses Dokument muss dem Schwimmbad-Eigentümer übergeben und muss von diesem an einem

## 1. VORWORT

---

Wir danken Ihnen, dass Sie sich zum Kauf einer Easy Temp-Wärmepumpe für Ihr Schwimmbad entschieden haben. Bei der Konzeption dieses Produkts wurde darauf geachtet, dass es den Herstellungsnormen exakt entspricht, damit das hohe Qualitätsniveau erreicht wird. Das vorliegende Handbuch enthält alle erforderlichen Informationen, betreffend Montage, Fehlerbeseitigung und Wartung. Lesen Sie dieses Handbuch bitte vor dem Öffnen der Einheit genau durch, bzw. bei der Durchführung von Wartungsarbeiten an dem Produkt.. Keine Haftung übernimmt der Hersteller dieses Produkt im Fall einer eventuellen Verletzung eines Benutzers oder der Beschädigung des Geräts im Ergebnis eventueller Fehler bei der Montage, der Behebung von Störungen oder einer fehlerhaften Wartung. Die in diesem Handbuch gegebenen Anweisungen müssen stets genau beachtet werden. Das Produkt muss durch qualifiziertes Personal montiert werden.

- Die Produktreparaturen müssen durch ein adäquat beruflich geschultes Personal durchgeführt werden.
- Sämtliche Stromanschluss-Arbeiten müssen von einem beruflich adäquat ausgebildeten Elektriker durchgeführt werden und müssen den Normen, die im jeweiligen Staat gelten, entsprechen ; siehe § 3.4.
- Die Wartung und die unterschiedlichen Tätigkeiten müssen in dem Rhythmus und zu den Zeitpunkten durchgeführt werden, wie sie im vorliegenden Handbuch angegeben sind.
- Benutzen Sie bitte nur Original-Ersatzteile.
- Die Garantie erlischt im Fall der Missachtung der Vorschriften.
- Diese Wärmepumpe erwärmt das Schwimmbeckenwasser und hält die Wassertemperatur konstant; das Produkt darf nicht zu anderen Zwecken benutzt werden.

Nachdem Sie dieses Handbuch gelesen haben, legen Sie es bitte zwecks späterer Benutzung an einen optimalen Platz.

Warnhinweis betreffend Kinder bzw. körperbehinderte Personen:

Dieses Gerät darf nicht von Personen (insbesondere nicht von Kindern) benutzt werden, deren körperliche, motorische oder geistige Fähigkeiten eingeschränkt sind oder von Personen, deren Erfahrung und Kenntnisse fehlen ; es sei denn, dass diese unter der Aufsicht kompetenter Personen handeln und die Anweisungen betreffend die Nutzung des Geräts durch eine Person, die für ihre Sicherheit bürgt, erhalten haben.

Zu diesem Produkt gehören Fluor-Treibhausgase, wie sie im Kyoto-Protokoll erfasst sind

Kühlmittel-Art: R410A

GWP-Wert GWP<sup>(1)</sup>: 1975

Je nach der europäischen oder nationalen Gesetzgebung können regelmäßige Inspektionen hinsichtlich der Überprüfung betreffend Kühlmittel-Leckagen vorgeschrieben sein. Nehmen Sie bitte mit Ihrem örtlichen Vertriebspartner Kontakt auf, der Ihnen weitere Informationen übermittelt.

---

(1) Potenzial für erneutes Aufwärmen insgesamt

## 2. TECHNISCHE MERKMALE

### 2.1 Technische Daten der Wärmepumpe

Modell	EASY TEMP	ECP 06	ECP 08	ECP 11	ECP 13	ECP 15
Wärmekapazität *	kW BTU/h	5,5 18785	8 27322	11 37566	13 46105	15 51228
Elektrischer Strom	kW	1,17	1,8	2,43	3	3,13
Ansprechstrom *	A	5,19	7,91	11,81	14,5	16
Stromversorgung	V Ph/Hz	230 V ~ 1/50 Hz	230 V ~ 1/50 Hz	230 V ~ 1/50 Hz	230 V ~ 1/50 Hz	230 V ~ 1/50 Hz
Größe der elektrischen Sicherung Typ aM	A	8 aM	10 aM	16 aM	20 aM	20 aM
Überlastschalter ), Dreiphasig + Nulleiter	A	8 D	10 D	16 D	20 D	20 D
Zahl der Kompressoren		1	1	1	1	1
Art des Kompressors		Drehend	Drehend	Drehend	Scroll (Rollen)	Scroll (Rollen)
Zahl der Ventilatoren		1	1	1	1	1
Energie der Ventilatoren	W	50	120	120	120	120
Rotationsgeschwindigkeit des Ventilators	mdrehungen pro Minute (UpM)	770	850	850	850	850
Richtung des Ventilators		Horizontal	Horizontal	Horizontal	Horizontal	Horizontal
Stufe der Druck-Geräuschentwicklung (in einem Meter)	dB(A)	47	51	54	56	56
Hydraulikanschluss	mm	50	50	50	50	50
Wasser-Ausgabe	m³/h	2,3	3,0	4,5	5,3	6,6
Wasserdruckverlust (max)	kPa	5,4	8,9	19,2	5,2	39,9
Netto-Abmessungen der Einheit (L//h)	mm	895/375/545	1035/415/650	1035/415/650	1136/440/870	1136/440/870
Abmessungen der verpackten Einheit (L//h)	mm	970/430/710	1120/480/810	1180/480/810	1230/510/1020	1230/510/1020
Nettogewicht / Gewicht der verpackten Einheit	kg	45/56	54/68	60/74	95/115	117/128



\* Wert zu +/- 5% bei folgenden Bedingungen: Außentemperatur = 24°C (75°F) / HR=62% / Temperatur des Schwimmbeckens=27°C (80°F)

## 2. TECHNISCHE MERKMALE (Fortsetzung)

---

### 2.2 Temperaturbereiche für die Funktion

Nutzen Sie bitte die Wärmepumpe innerhalb der folgenden Temperatur- und Feuchtigkeits-Bereiche, damit eine sichere und effiziente Funktion gewährleistet ist.

	Heiz-Modus 	Kühl-Modus 
Außentemperatur	+2°C ~ +35°C	+7°C ~ +43°C
Wassertemperatur	+12°C ~ +40°C	+8°C ~ +40°C
Relative Feuchtigkeit	< 80%	< 80%
Punkte der Einstellbereiche je nach Vorgabe	+15°C ~ +40°C	+8°C ~ +35°C



***Falls die Temperatur oder die Feuchtigkeit diesen Vorgabewerten nicht entspricht, könnten sich die Sicherheitssysteme einschalten und die Wärmepumpe funktioniert dann nicht mehr.***

## 2. TECHNISCHE MERKMALE (Fortsetzung)

### 2.3 Abmessungen

Modelle: ECP06 / ECP08 / ECP11 / ECP13 / ECP15

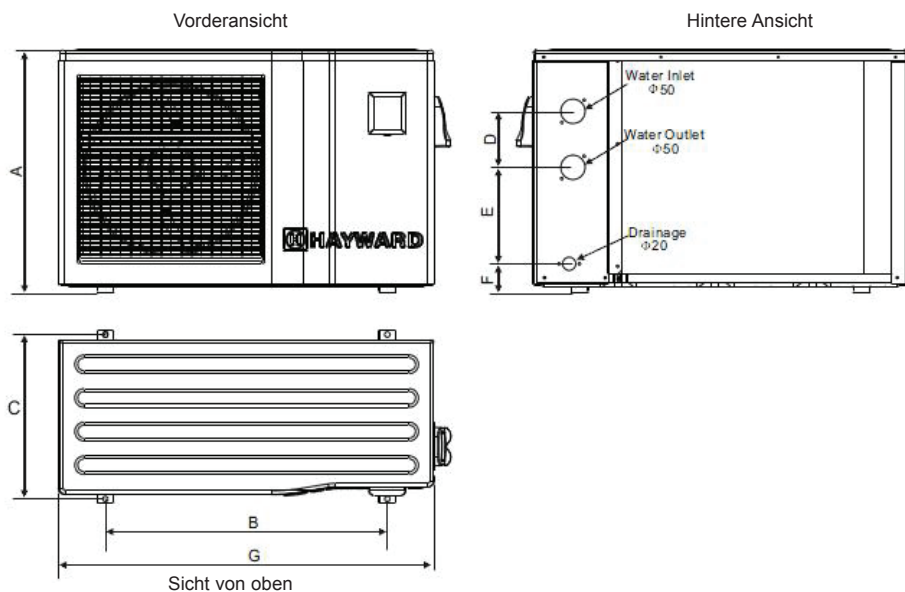

Einheit: mm

Modell / Markierung	ECP06	ECP08 ECP11	ECP13 ECP15
<b>A</b>	540	648	866
<b>B</b>	571	755	840
<b>C</b>	400	440	470
<b>D</b>	140	150	150
<b>E</b>	258	258	330
<b>F</b>	66	77	80
<b>G</b>	860	1004	1114

# 3. INSTALLATION UND ANSCHLÜSSE

## 3.1 Grundschalbild

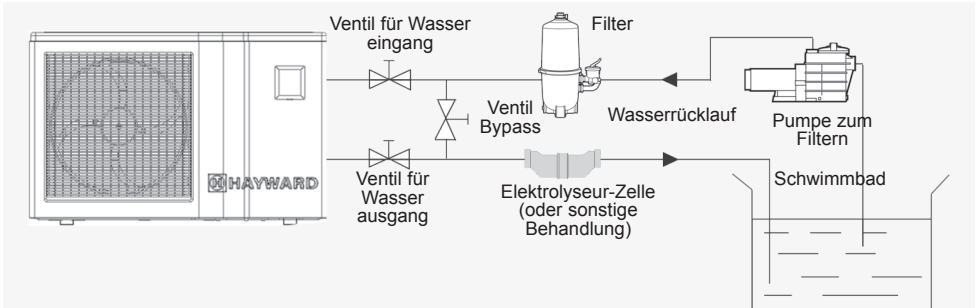

Anmerkung: Die Wärmepumpe wird ohne Behandlungs- und Filter-Element geliefert. Bei den auf dem Schema dargestellten Teilen handelt es sich um Bestandteile, die der Monteur zu liefern hat.

## 3.2 Wärmepumpe



**Positionieren der Wärmepumpe im Außenbereich und außerhalb eines geschlossenen Technikraumes.**

**In einem abgedeckten Bereich positionieren, die unten stehend vorgeschriebenen Mindestentfernungen müssen beachten werden, damit das Risiko der Luft-Rezirkulation und allgemein eine Leistungsminderung der Wärmepumpe vermieden wird.**

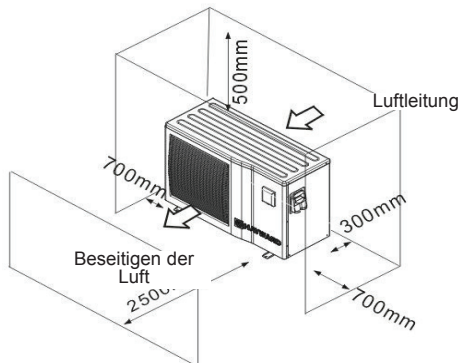



### 3. MONTAGE UND ANSCHLUSS (Fortsetzung)

---



*Die Wärmepumpe sollte optimalerweise auf einer speziellen Betonplatte oder einem Fixierungs-Block installiert werden, der spezifisch für diesen Zweck vorgesehen ist, und die Wärmepumpe ist auf dem gelieferten Gummilager-Element (Silentbloc) zu montieren; (Schrauben und Plättchen werden nicht mitgeliefert).*

*Die maximale Montage-Entfernung zwischen Wärmepumpe und Schwimmbad beträgt 15 Meter.*

*Die Gesamtlänge der Hydraulikleitungen für Hin- und Rückfluss beträgt 30 Meter.*

*Isolieren der Hydraulikleitungen an der Oberfläche und im Boden.*

#### 3.3 Hydraulikanschluss

Die Wärmepumpe wird mit zwei gemeinsamen Verbindungsschraubteilen geliefert, mit einem Durchmesser von 50 mm. Das PVC-Rohr ist als Hydraulikleitung zu nutzen Ø 50 mm. Anschließen des Wassereingangsbereichs der Wärmepumpe an die Leitung, die aus der Filter-Einheit kommt und dann Anschließen des Wasser-Ausgangs der Wärmepumpe an das aus dem Becken kommende Wasserrohr (siehe das unten stehende Schema).

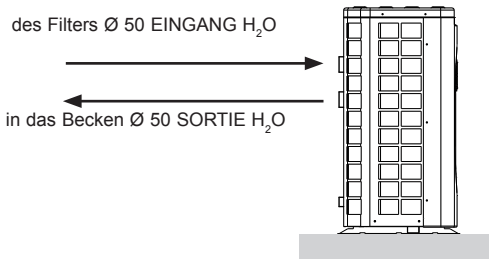

Montieren eines "Bypass" genannten Ventils zwischen Wärmepumpen-Eingang und -Ausgang.



*Falls ein automatischer Verteiler oder Elektrolyser benutzt wird, muss er unbedingt nach der Wärmepumpe installiert werden, damit der Titan-Kondensator gegen zu hohe Konzentrationen chemischer Substanzen geschützt ist.*



*Achten Sie bitte darauf, dass das Bypass-Ventil und die Anschlüsse exakt auf der Höhe des Wasser-Eingangs und Wasser-Ausgangs der Einheit installiert werden, um das Entleeren während der Wintermonate zu vereinfachen, den Zugang bzw. das Abmontieren zwecks Wartungsarbeiten problemloser zu gestalten.*

### 3. MONTAGE UND ANSCHLUSS (Fortsetzung)

#### 3.4 Stromanschluss



**Die Installation der Stromleitungen und die Verkabelung dieser Einrichtung müssen den in den jeweiligen Staaten geltenden gesetzlichen Montage-Vorschriften entsprechen.**

F	NF C15-100	GB	BS7671:1992
D	DIN VDE 0100-702	EW	EVHS-HD 384-7-702
A	ÖVE 8001-4-702	H	MSZ 2364-702/1994/MSZ 10-553 1/1990
E	UNE 20460-7-702 1993, RECBT ITC-BT-31 2002	M	MSA HD 384-7-702.S2
IRL	Wiring Rules + IS HD 384-7-702	PL	PN-IEC 60364-7-702:1999
I	CEI 64-8/7	CZ	CSN 33 2000 7-702
LUX	384-7.702 S2	SK	STN 33 2000-7-702
NL	NEN 1010-7-702	SLO	SIST HD 384-7-702.S2
P	RSIUEE	TR	TS IEC 60364-7-702



**Überprüfen Sie bitte die zur Verfügung stehende Stromversorgung und die Netzfrequenz hinsichtlich der vorgeschriebenen Funktion ; beachten Sie dabei bitte auch den spezifischen Ort, an dem das Gerät positioniert ist und den erforderlichen Strom, der für andere eventuell am selben Stromkreis angeschlossene Geräte erforderlich ist.**

**ECP 06 230 V~ +/- 10 % 50 HZ 1 Phase**

**ECP 08 230 V~ +/- 10 % 50 HZ 1 Phase**

**ECP 11 230 V~ +/- 10 % 50 HZ 1 Phase**

**ECP 13 230 V~ +/- 10 % 50 HZ 1 Phase**

**ECP 15 230 V~ +/- 10 % 50 HZ 1 Phase**

**Beachten Sie bitte das entsprechende Kabelführungs-Schema, das sich im Anhang befindet.**

**Das Stromanschlussgehäuse befindet sich auf der rechten Seite des Gerätes. Für die Stromversorgung sind drei Verbindungen vorgesehen und zwei für die Steuerung der Filterpumpe (Regelungs-system).**

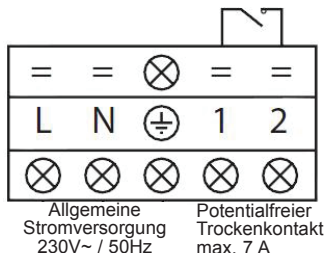

## 3. MONTAGE UND ANSCHLUSS (Fortsetzung)

---



**Die Stromleitung muss über ein adäquates Sicherheitssystem für die spezielle Motorstrom-Energieversorgung (aM) oder einen Überlastschalter mit drei Phasen und Nulleiter verfügen und zudem über einen FI-Schutzschalter 30mA (siehe nachstehende Übersicht).**

Modelle		ECP 06	ECP 08	ECP 11	ECP 13	ECP 15
tromversorgung	V/Ph/ Hz	230 V~ 1/50 Hz	230 V~ 1/50 Hz	230 V~ 1/50 Hz	230 V~ 1/50 Hz	230 V~ 1/50 Hz
Größe der elektrischen Sicherung Typ aM	A	8 aM	10 aM	16 aM	20 aM	20 aM
Überlastschalter Dreiphasig+ Nulleiter	A	8 D	10 D	16 D	20 D	20 D



**Achten Sie immer darauf, die Hauptstromversorgung vor dem Öffnen des Strom-steuerungsgehäuses abzuschalten.**

### 3.5 Erste Betriebstätigkeit (Start)

Verfahren beim Start – sobald die Montage abgeschlossen ist, bitte folgende Abschnitte beachten und einhalten:

- 1) Drehen Sie den Ventilator mit der Hand, damit Sie überprüfen können, dass er sich frei bewegt und die Schraube exakt auf der Antriebswelle fixiert ist.
- 2) Überprüfen Sie, dass die Einheit vorschriftsmäßig an die Hauptstromversorgung angeschlossen ist (siehe dazu das Verkabelungsschema im Anhang).
- 3) Einschalten der Filterpumpe.
- 4) Überprüfen Sie, dass sämtliche Wasserventile geöffnet sind und das Wasser in die Einheit fließt, bevor der Heiz-Modus oder der Kühl-Modus eingeschaltet wird.
- 5) Überprüfen Sie, dass das Entlüftungsrohr exakt fixiert ist und keine Hinderung vorliegt.

### 3. MONTAGE UND ANSCHLUSS (Fortsetzung)

---

- 6) Einschalten der Stromversorgung für die Einheit, dann auf den Knopf Start/Stop drücken  auf dem Steuerungsschild.
- 7) Achten Sie darauf, dass kein ALARM-Code angezeigt wird, wenn Sie die Einheit auf ON (EIN) schalten (siehe die Fehlerbehebungs-Anleitung).
- 8) Befestigen Sie die Wasserausgabe mit Hilfe eines By-Pass-Ventils (siehe § 3.6 und 2.1), wie dies für jedes Modell vorgesehen ist, damit Sie einen Temperatur-unterschied von 2% bei Eingang/Ausgang erreichen.
- 9) Nachdem die Einheit einige Minuten eingeschaltet war, überprüfen Sie, dass die der Einheit entweichende Luft wieder kalt ist (zwischen 5° C und 10° C).
- 10) Bei eingeschalteter Einheit bitte Filterpumpe ausschalten. Die Einheit muss sich automatisch abschalten und die Fehlermeldung E03 anzeigen.
- 11) Lassen Sie die Einheit und die Schwimmbadpumpe 24 Stunden lang bis zur Erreichung der gewünschten Wassertemperatur kontinuierlich laufen. Sobald die Temperatur der Wasserzuleitung den vorgeschriebenen Wert erreicht hat, schaltet sich die Einheit ab. Dann startet sie erneut (sofern die Schwimmbadpumpe in Betrieb ist), falls der Schwimmbadtemperatur –Wert mindestens 0,5° C unter der eingestellten Temperatur liegt.

**Ausgabe-Überwachung** – Die Einheit ist mit einem Ausgabe-Regler ausgestattet, der die Wärmepumpe einschaltet, sobald die Filterpumpe des Schwimmbads in Betrieb ist und sie schaltet ab, sobald die Filterpumpe außer Betrieb ist. Im Fall fehlenden Wassers leuchtet der Alarm-Code E03 des Regulierungselements auf (Siehe § 6.4).

**Verzögerungsrelais** – Im gerät befindet sich ein Verzögerungs-Relais von 3 Minuten, damit die Teile des Steuerungszyklus geschützt sind, jede Instabilität bei erneutem Start vermieden und beim Kontaktgeber jede Interferenz vermieden wird. Dank des Verzögerungs-schalters startet das Gerät nach etwa drei Minuten erneut automatisch, und zwar nach einer Unterbrechung des Steuerungszyklus. Auch bei kurzer Strom-Unterbrechung schaltet sich der Verzögerungsschalter für den Startvorgang ein.

# 3. MONTAGE UND ANSCHLUSS (Fortsetzung)

## 3.6 Regulierung der Wasserausgabe

Sobald die Wärmepumpe funktioniert und die Ventile für Wasser-Eingang und -Ausgang geöffnet sind, muss das Ventil, das « By-Pass »-Ventil genannt wird, reguliert werden, damit eine Temperatur-Differenz von 2° C bei Wasser-Eingang und - Ausgang erreicht wird (siehe das Grundschaftbild § 3.1). Sie können die Regulierung überprüfen, indem Sie sich die Temperaturwerte für Eingang (T02) / Ausgang (T03) anzeigen lassen, direkt auf der Steuerungsschild und dabei unten angegebenes Verfahren beachten.

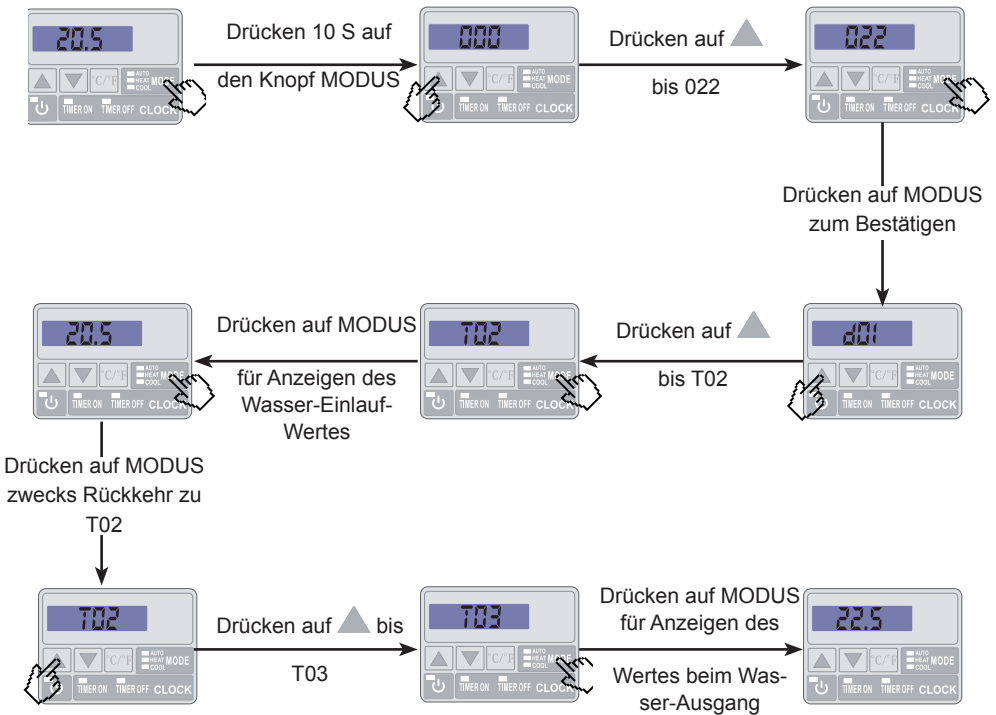

Dann Einstellen Ihres By-pass damit eine Temperatur-differenz von 2° C zwischen T03 und T02 ( $T03 - T02 = \Delta T = 2$ ) entsteht.

Zweimal Drücken auf  um das Menü zu verlassen

Anmerkung: Die Öffnung des “By-pass” genannten Ventils bewirkt eine geringe Ausgabe oder eine Erhöhung des  $\Delta T$ .  
Die Schließung des “By-pass” Ventil genannten Teils bewirkt eine größere Wasserausgabe oder eine Verminderung des  $\Delta T$ .

## 4. NUTZERSCHNITTSTELLE







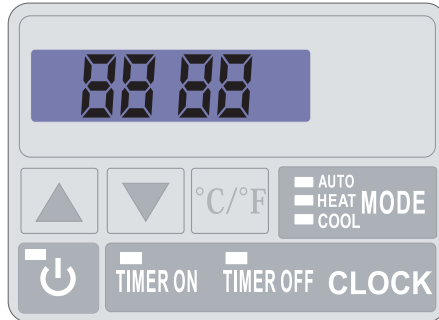

---

### 4.1 Allgemeine Darstellung

Die Wärmepumpe ist mit einer elektronischen Steuerungs-Anzeige ausgestattet, die an den Stromkreis angeschlossen ist und im Werk für den Heizmodus voreingestellt wird.



#### Erläuterung

-  **COOL** Symbol des Kühl-Modus
-  **HEAT** Symbol des Heiz-Modus
-  **AUTO** Automatik-Modus
-  **CLOCK** Einstellung der Uhrzeit und des Timers
-  **MODE** Knopf Auswahl und Regelung.
-  **Power** Knopf Start/Stop und Zurück/Validierung
-  **Down Arrow** Abrollen nach unten
-  **Up Arrow** Rollen nach oben
-  **TIMER ON** Einstellung der Start-Uhrzeit
-  **TIMER OFF** Einstellung der Stopp-Uhrzeit

## 4. BENUTZERSCHNITTSTELLE (Fortsetzung)

---

### Ausschalt-Modus OFF

Wenn die Wärmepumpe im Wartezustand (OFF-Modus) ist, werden auf dem Regulierungs-Display die Uhrzeit und auch die Funktionsweise angezeigt.

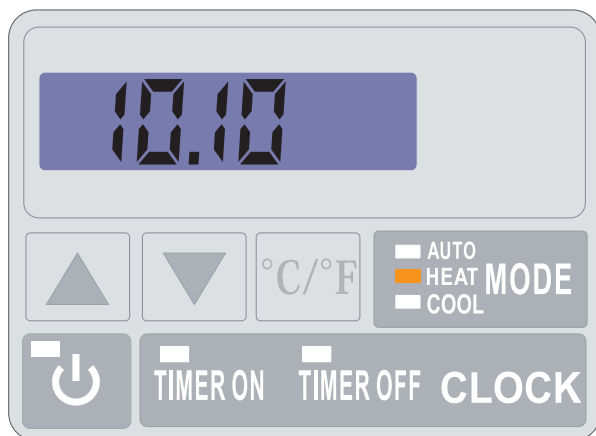

### Modus EINGESCHALTET (ON)



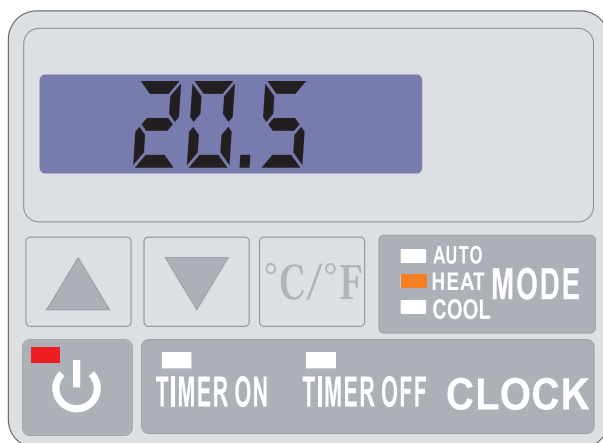

Wenn sich die Wärmepumpe im Funktions- oder Regelungs-Modus befindet (EINGESCHALTET – ON), leuchtet der Betriebstätigkeits-Knopf rot und auf dem Display erscheint die Wasser-Eingangstemperatur.



## 4. BENUTZERSCHNITTSTELLE (Fortsetzung)

---

### 4.2 Regulierung des Zeitgebers





Die Zeitgeber-Programmierung kann im Einschalt-Modus (ON) oder im Ausschalt-Modus (OFF) erfolgen. Drücken auf «UHR», die Anzeige blinkt, dann auf «UHR» drücken, die Stundenangabe blinkt. Einstellen der Uhrzeit mittels der Pfeile  oder  dann zwecks Festlegung der Minuten erneut auf «UHR» drücken. Einstellen der Minuten mittels der Pfeile  oder . Zwecks Bestätigen auf «UHR» drücken. Die Anzeige wechselt zum vorherigen Zustand.

Hinweis: Die Regulierungssicherungen erfolgen mittels Betätigung des Knopfes «UHR» oder erfolgt automatisch, sofern innerhalb von 5 Sekunden keinerlei Knopf betätigt wird.

### 4.3REinstellen der Timer-Funktion

Notwendig ist die Einstellung dieser Funktion, sofern Ihre Wärmepumpe in einem kürzeren Zeitraum funktionieren soll, als demjenigen, der von dem Filter-Zeitgeber festgelegt wurde. Daher können Sie einen zeitlich versetzten Start und ein vorheriges Anhalten programmieren oder auch ein Funktions-Zeitfenster (beispielsweise Nachtstunden) einfach sperren.





#### Programmierung Beginn (Timer ON)(Timer EIN) / Betrieb

- 1) Drücken auf «Timer ON» (Timer EIN), die Zeitangabe blinkt.
- 2) Drücken auf «Timer ON» (Timer EIN) zwecks Einstellung der Stunden mittels Betätigung der Knöpfe  .
- 3) Drücken «Timer ON» (Timer EIN) zwecks Einstellung der Minuten mittels der Knöpfe  .

Die Speicherung der Einstellungen erfolgt mittels des Knopfes «Timer ON, TIMER EIN» oder geschieht automatisch, falls innerhalb von 5 Sekunden keine Taste betätigt wird.

Ein grünes Fenster informiert über den Einschaltzustand des Timers..

#### Programmierung des Stopps (Timer OFF) (Timer AUS) / Stopp

- 1) Drücken auf «Timer OFF» (Timer AUS), die Zeitangabe blinkt.
- 2) Drücken auf «Timer OFF» (Timer AUS) zwecks Einstellung der Stunden mittels der Knöpfe  .
- 3) Drücken auf «Timer OFF» (Timer AUS) zwecks Einstellung der Minuten mittels der Knöpfe  .

Die Speicherung der Einstellungen erfolgt mittels Betätigung des Knopfes «Timer OFF»

(Timer AUS) oder geschieht automatisch, falls innerhalb von 5 Sekunden keine Taste betätigt wurde.



Ein rotes Fenster gibt an, dass der Timer eingeschaltet ist.



## 4. BENUTZERSCHNITTSTELLE (Fortsetzung)

---

### Ausschalten der Timer (Timer ON (EIN) und OFF/AUS ) / Stopp und Start

- 1) Drücken auf «Timer ON –Timer EIN», «Timer ON» Timer-EIN blinkt.
- 2) Drücken  zum Ausschalten der Programmierung.
- 3) Drücken «Timer OFF/Timer AUS», «Timer OFF» Timer-AUS blinkt.
- 4) Drücken  zum Ausschalten der Programmierung.

### 4.4 Bestimmung des Funktions-Modus: Heizung, Kühlung oder Automatik.

#### Im Modus “OFF” (AUS) oder “ON” (EIN)

Drücken des Knopfes «MODUS» zwecks Wechsel vom Kühl-Modus (grünes Fenster) zum Heiz-Modus (orangerfarbiges Fenster) zum Automatik-Modus (rotes Fenster).

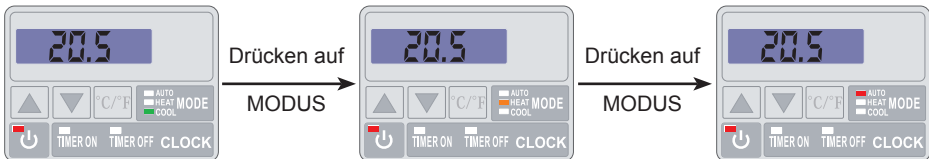



## 4. BENUTZERSCHNITTSTELLE (Fortsetzung)

---

### 4.5 Einstellung und Anzeige des Einstellwertes (gewünschte Wasser-temperatur)

#### Im Modus "OFF" (AUS) und Modus "ON" (EIN)

Drücken der Knöpfe  oder  für die Festlegung des gewünschten Einstellwertes. Die Einstellung erfolgt bei einer Genauigkeit von 0,5 °C.



*Es wird empfohlen, die Temperatur von 30° C. niemals zu überschreiten, um die Beschädigung der Liner zu vermeiden.*

Anmerkung: Für die Einschaltfunktion oder den Stopp muss nur auf den Knopf gedrückt werden  oder  zwecks Anzeigen oder Ändern des Einstellwertes.

### 4.6 Blockieren und Freigabe des Berührungsbildschirms

Drücken des Knopfes Betrieb/Stopp , 5 Sekunden lang, bis ein Tonsignal (Piep) zu hören ist. Die Berührungsflächen schalten sich aus.

Die Freigabe erfolgt mittels Drücken , 5 Sekunden lang, bis ein Tonsignal (Piep) zu hören ist.

Die Funktion der Berührungsflächen ist damit wieder aktiviert.

## 5. WARTUNG UND VORBEREITUNG ZUM WINTERFESTMACHEN DES PRODUKTS

---

### 5.1 Produktwartung

Diese Maßnahmen müssen einmal jährlich durchgeführt werden, damit die Langlebigkeit und die fehlerfreie Funktion der Wärmepumpe gewährleistet bleiben

- Reinigen des Verdampfers mittels einer weichen Bürste oder mittels Luft- oder Wasserdruck (**Warnung: Niemals ein Hochdruckgerät benutzen**).
- Überprüfen des problemlosen Kondensat-Abflusses.
- Überprüfen der Klemmung der Hydraulik- und Stromverbindungen



***Vor jeder Wartungs-Tätigkeit muss eine Trennung der Wärmepumpe von der Stromversorgung erfolgen. Die Wartungsarbeiten dürfen nur von fachlich geschultem Personal durchgeführt werden, das auch hinsichtlich der Kühlmittel-Handhabung über die erforderliche Kompetenz verfügt.***

- Überprüfen der Hydraulikdichtigkeit des Kondensators.

### 5.2 Winterfest machen

- Die Wärmepumpe muss in den « Off »(Aus)-Modus geschaltet werden.
- Zuleitung zur Wärmepumpe abstellen.
- Entleeren des Kondensators mittels eines Ablasses, damit jegliches Beschädigungsrisiko ausgeschlossen ist. (Großes Frostrisiko).
- Schließen des “Bypass”-Ventils und Abschrauben der d Verbindungsscharubteile für Eingang und Ausgang.
- Möglichst viel verbliebenes Restwasser mittels einer Ausblaspistole aus dem Kondensator beseitigen.
- Verschließen von Wasser-Eingang und –Ausgang der Wärmepumpe, damit das Eindringen von Fremdkörpern verhindert wird.
- Abdecken der Wärmepumpe mit einer Winterdecke; (diese wird nicht mitgeliefert).



***Der Garantieanspruch verfällt, falls die Winterfestmachung unsachgemäß erfolgte und daraufhin eine Beschädigung des Produkts eintrat.***

# 6. ANHÄNGE

## 6.1 Stromlaufpläne

ECP 06

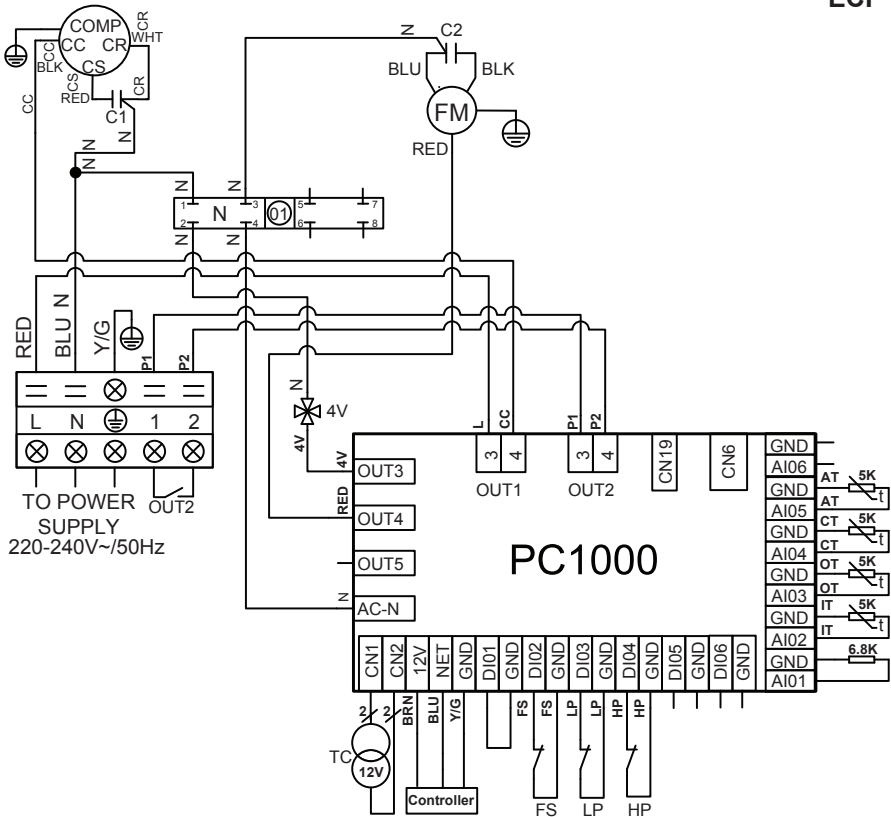

**HINWEISE:**

- AT : SENSOR FÜR DIE LUFTTEMPERATUR
- COMP : KOMPRESSOR
- CT : SENSOR FÜR DIE VERDUNSTERTEMPERATUR
- FM : VENTILATORMOTOR
- FS : SENSOR FÜR VORHANDENES WASSER
- HP : DRUCKREGLER HOCHDRUCK
- IT : SENSOR FÜR DIE TEMPERATUR DES EINGANGS-WASSERS

- LP : DRUCKREGLER FÜR NIEDERDRUCK
- OT : SENSOR FÜR DIE TEMPERATUR AM WASSER-AUSGANG
- TC : TRANSFORMATOR 230V~ / 12V~
- 4V : VENTIL 4 WEGE
- C1 : KOMPRESSOR-KONDENSATOR
- C2 : VENTILATOR-KONDENSATOR
- OUT2 : POTENTIALFREIER TROCKENKONTAKT MAX. 7 A

# 6. ANHÄNGE (Fortsetzung)

ECP 08

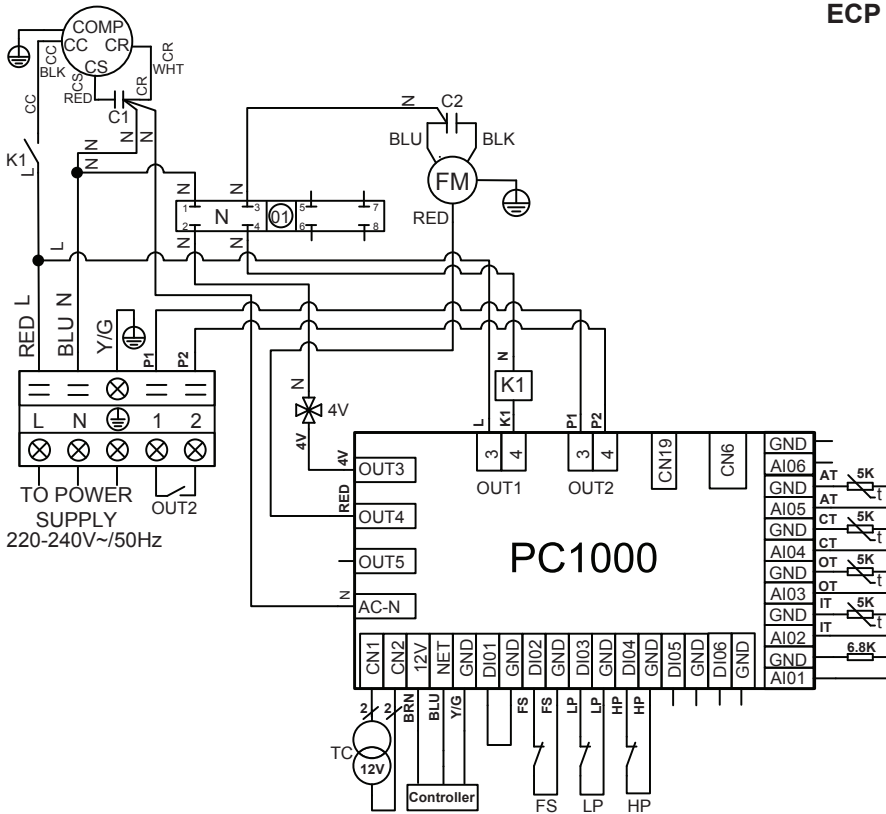

**HINWEISE:**

AT : SENSOR FÜR DIE LUFTTEMPERATUR  
 COMP : KOMPRESSOR  
 CT : SENSOR FÜR DIE VERDUNSTERTEMPERATUR  
 FM : VENTILATORMOTOR  
 FS : SENSOR FÜR VORHANDENES WASSER  
 HP : DRUCKREGLER HOCHDRUCK  
 IT : SENSOR FÜR DIE TEMPERATUR DES EINGANGS-  
 WASSERS

OT : SENSOR FÜR DIE TEMPERATUR AM WASSER-  
 AUSGANG

TC : TRANSFORMATOR 230V~ / 12V~

4V : VENTIL 4 WEGE

K1 : KOMPRESSOR-RELAIS

C1 : KOMPRESSOR-KONDENSATOR

C2 : VENTILATOR-KONDENSATOR

OUT2 : POTENTIALFREIER TROCKENKONTAKT MAX. 7 A

LP : DRUCKREGLER FÜR NIEDERDRUCK

# 6. ANHÄNGE (Fortsetzung)

ECP 11

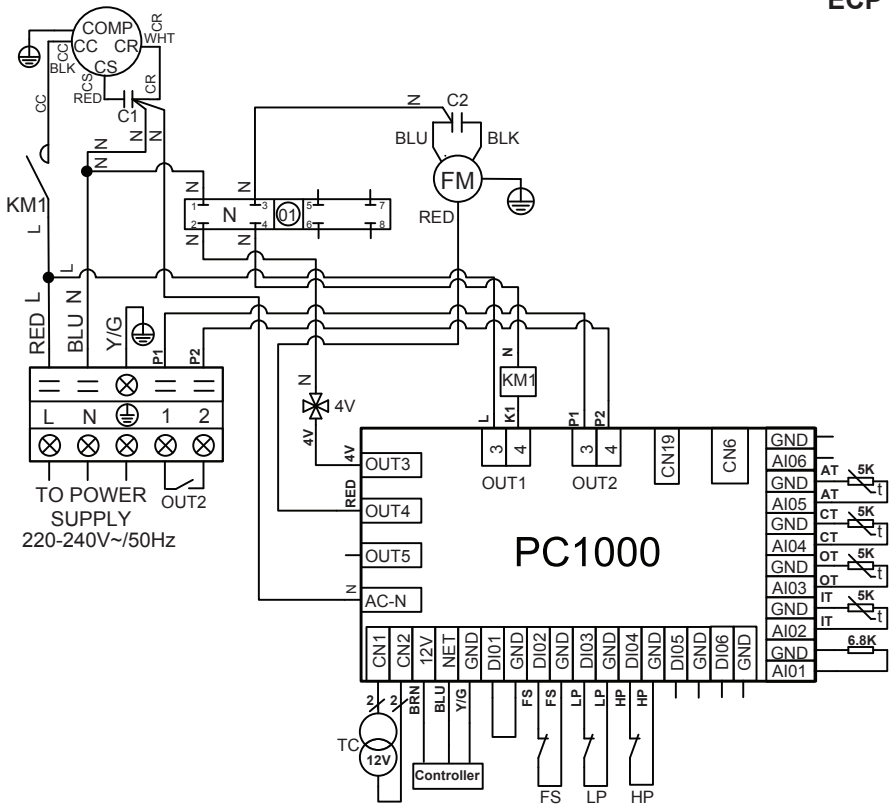

**HINWEISE:**

- AT : SENSOR FÜR DIE LUFTTEMPERATUR
- COMP : KOMPRESSOR
- CT : SENSOR FÜR DIE VERDUNSTERTEMPERATUR
- FM : VENTILATORMOTOR
- FS : SENSOR FÜR VORHANDENES WASSER
- HP : DRUCKREGLER HOCHDRUCK
- IT : SENSOR FÜR DIE TEMPERATUR DES EINGANGS-WASSERS

- LP : DRUCKREGLER FÜR NIEDERDRUCK
- OT : SENSOR FÜR DIE TEMPERATUR AM WASSER-AUSGANG
- TC : TRANSFORMATOR 230V~ / 12V~
- 4V : VENTIL 4 WEGE
- KM1: IMPULSGEBER FÜR KOMPRESSOR-ENERGIE
- C1:KOMPRESSOR-KONDENSATOR
- C2:VENTILATOR-KONDENSATOR
- OUT2 : POTENTIALFREIER TROCKENKONTAKT MAX. 7 A

# 6. ANHÄNGE (Fortsetzung)

ECP 13

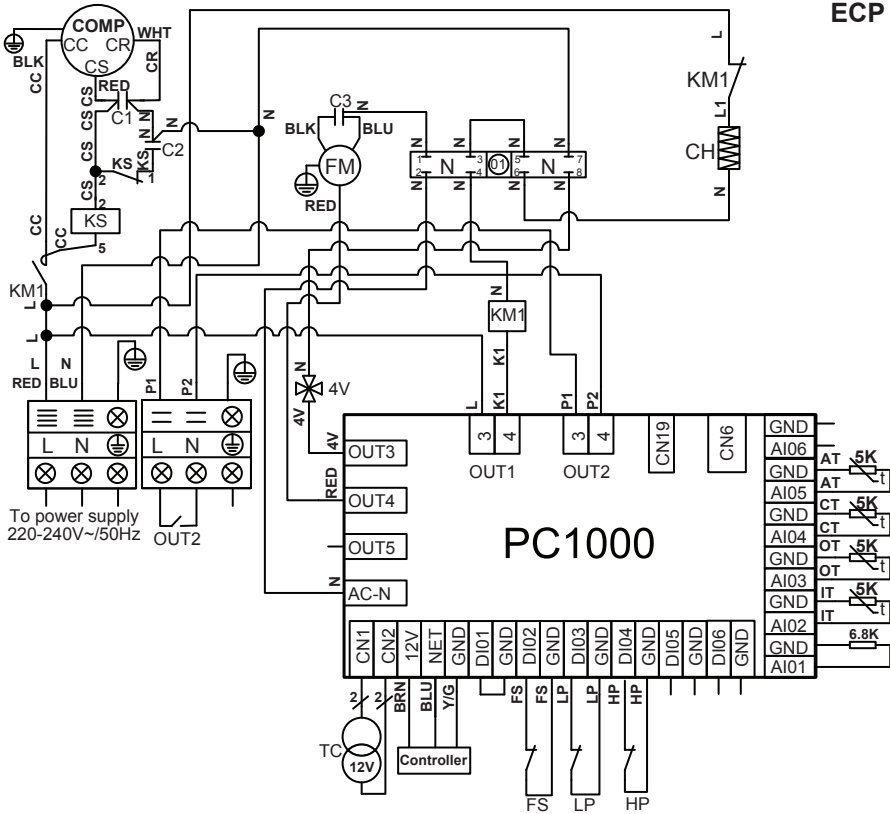

**HINWEISE:**

AT : SENSOR FÜR DIE LUFTTEMPERATUR  
 COMP : KOMPRESSOR  
 CH : WIDERSTAND DES GEHÄUSES  
 CT : SENSOR FÜR DIE VERDUNSTERTEMPÉRATUR  
 FM : VENTILATORMOTOR  
 FS : SENSOR FÜR VORHANDENES WASSER  
 HP : DRUCKREGLER HOCHDRUCK  
 IT : SENSOR FÜR DIE TEMPERATUR  
 DES EINGANGS- WASSERS

KS : SPULE FÜR DEN KOMPRESSOR-STARTVORGANG  
 LP : DRUCKREGLER FÜR NIEDERDRUCK  
 OT : SENSOR FÜR DIE TEMPERATUR AM WASSER-AUSGANG  
 TC : TRANSFORMATOR 230V~ / 12V~  
 4V : VENTIL 4 WEGE  
 KM1 : IMPULSGEBER FÜR DIE KOMPRESSOR-ENERGIEZUFUHR  
 C1 : STÄNDIGER KONDENSATOR  
 C2 : START-KONDENSATOR  
 OUT2 : POTENTIALFREIER TROCKENKONTAKT MAX. 7 A

# 6. ANHÄNGE (Fortsetzung)

ECP 15

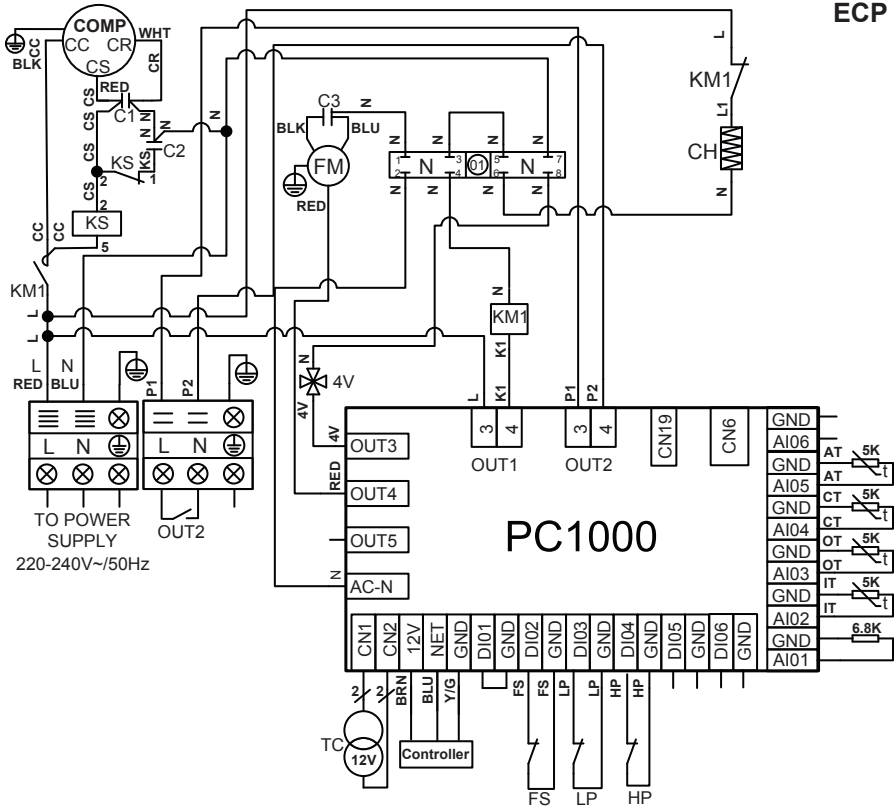

**HINWEISE:**

AT : SENSOR FÜR DIE LUFTTEMPERATUR  
 COMP : KOMPRESSOR  
 CH : WIDERSTAND DES GEHÄUSES  
 CT : SENSOR FÜR DIE VERDUNSTERTEMPERATUR  
 FM : VENTILATORMOTOR  
 FS : SENSOR FÜR VORHANDENES WASSER  
 HP : DRUCKREGLER HOCHDRUCK  
 IT : SENSOR FÜR DIE TEMPERATUR  
 DES EINGANGS- WASSERS

KS : SPULE FÜR DEN KOMPRESSOR-STARTVORGANG  
 LP : DRUCKREGLER FÜR NIEDERDRUCK  
 OT : SENSOR FÜR DIE TEMPERATUR AM WASSER-AUSGANG  
 TC : TRANSFORMATOR 230V~ / 12V~  
 4V : VENTIL 4 WEGE  
 KM1 : IMPULSGEBER FÜR DIE KOMPRESSOR-ENERGIEZUFUHR  
 C1 : STÄNDIGER KONDENSATOR  
 C2 : START-KONDENSATOR  
 OUT2 : POTENTIALFREIER TROCKENKONTAKT MAX. 7 A



# 6. ANHÄNGE (Fortsetzung)

## 6.2 Vorrangige Anschlüsse für die einphasige Pumpen-Heizung

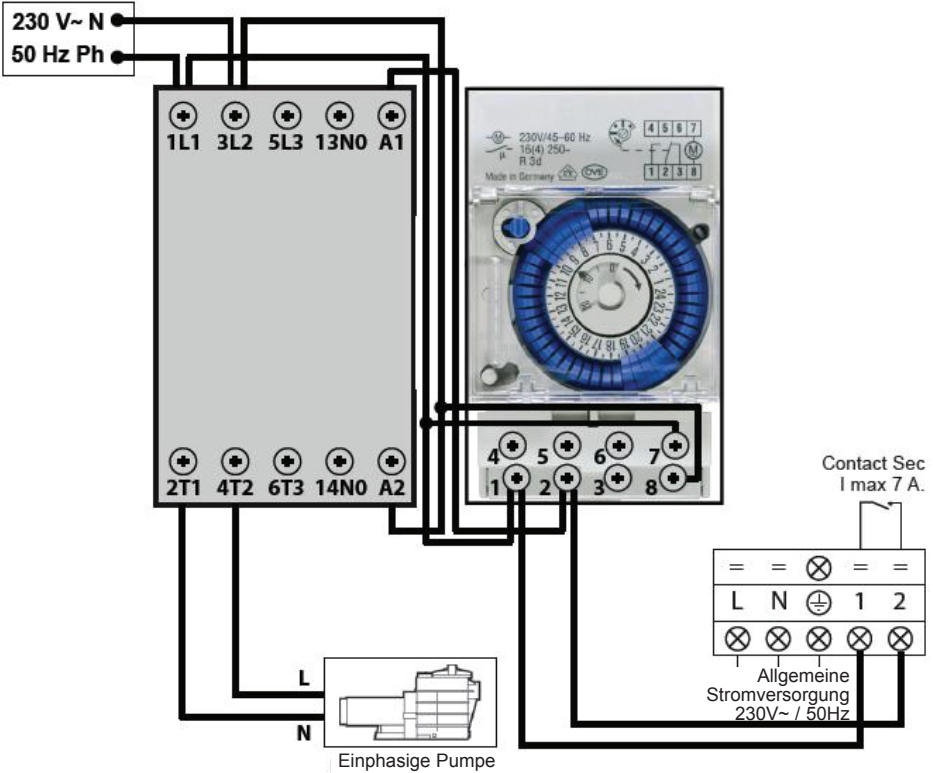

Außerhalb des Filter-Bereichs muss eine Wassertemperatur-Abfrage mittels regelmäßigem Start der Filterpumpe (15 Minuten alle 2 Stunden erfolgen). Falls die Wärmepumpe in diesem Abfragezeitraum einen Bedarf hat, wird diese mit der Vorrangstellung für die Heizung starten und dies beibehalten.



**!** Die Stromversorgung der Filtrationspumpe niemals direkt an die Anschlüsse 1 und 2 anschließen.

# 6. ANHÄNGE (Fortsetzung)

## 6.3 Perspektivische Darstellungen und Bauteile

ECP 06

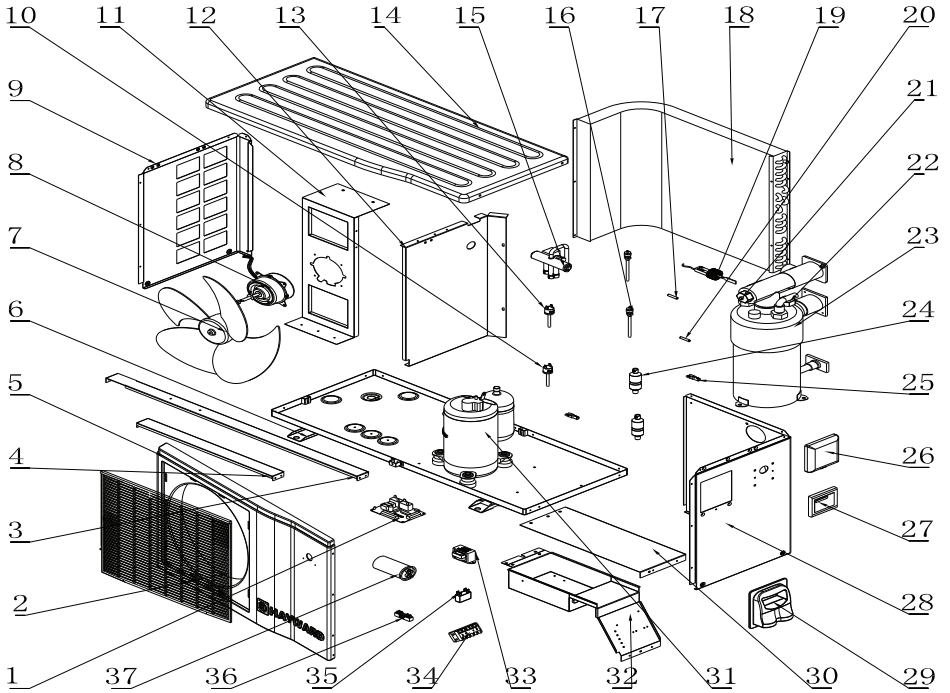

## 6. ANHÄNGE (Fortsetzung)

---

### ECP 06

Rep	Ref.	Bezeichnung	Rep	Ref.	Bezeichnung
1	HWX950531145	Elektronikkarte PC1000	20	HWX20003242	Temperatur-Sonde
2	HWX35252208	Gitter	21	HWX20003242	Temperatur-Sonde
3	HWX322521062	Aussteifung Hinten	22	HWX20003242	Temperatur-Sonde
4	HWX322521063	Aussteifung vorne	23	HWX32251210	Titan/PVC-- Kondensator
5	HWX32025210084	Schild ABS Vorne	24	HWX20041444	Filter (Ø9.7-Ø9.7)
6	HWX32025210081	Gestell	25	HWX200014068	Kapillar- Verbindungsstück
7	HWX34012701	Ventilatorblatt	26	HWX20002111	Schutz des Kontrollgeräts
8	HWX34013301	Ventilationsmotor	27	HWX950531188	Kontrollgerät mit 7 Segmenten
9	HWX32025210083	Linkes Schild	28	HWX32025210082	Rechtes Schild
10	HWX20003603	Druckregler Niedrigdruck	29	HWX32009220054	Handgriff
11	HWX322521061	Motorträger	30	HWX322521064	HWX322521064
12	HWX322521059	Trennungsschild	31	HWX322521064	ompressor
13	HWX20013605	Druckregler Hochdruck	32	HWX322521006	Schaltkasten
14	HWX32025210085	ABS-Schild im oberen Bereich	33	HWX200037006	Transformator 230V~/12V~
15	HWX20011418	Ventil mit 4 Wegen	34	HWX40003901	Stromklemmleiste mit 5 Anschlüssen
16	HWX200014153	Valve Shrader	35	HWX20003506	HWX20003506
17	HWX20003242	Temperatur-Sonde	36	HWX20003909	Klemmleiste mit 2 Anschlüssen
18	HWX40001230	Verdunster	37	HWX20003504	HWX20003504
19	HWX200036005	Ausgabe-Sensor	38	HWX20009910	Kapillare

## 6. ANHÄNGE (Fortsetzung)

---

### ECP 08

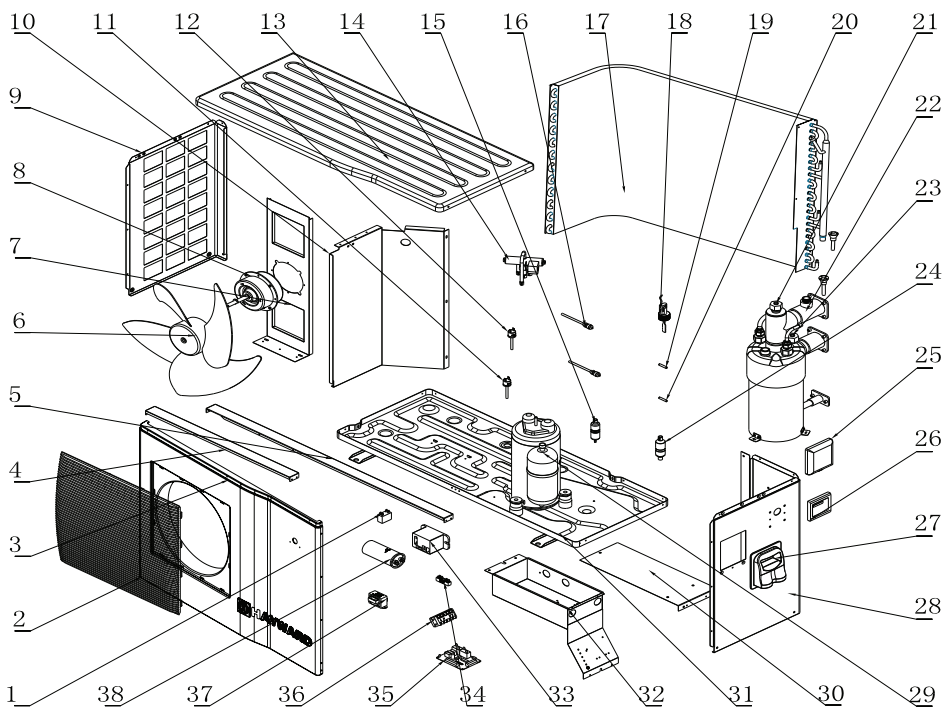

## 6. ANHÄNGE (Fortsetzung)

### ECP 08

Rep	Ref.	Bezeichnung	Rep	Ref.	Bezeichnung
1	HWX20003501	Kondensator Ventilator 3µF	21	HWX20003242	Temperatur-Sonde
2	HWX35122213	Gitter	22	HWX32081205	Titan/PVC-- Kondensator
3	HWX32012210240	Schild ABS Vorne	23	HWX20003242	Temperatur-Sonde
4	HWX321221175	Aussteifung vorne	24	HWX20041445	Filter(Φ9.7-Φ4.2)
5	HWX321221018	Aussteifung Hinten	25	HWX20002111	Schutz des Kontrollgeräts
6	HWX35002701	Ventilatorblatt	26	HWX950531188	Kontrollgerät mit 7 Segmenten
7	HWX321221174	Motorträger	27	HWX32009220054	Handgriff
8	HWX34043301	Ventilationsmotor	28	HWX32012210238	Rechtes Schild
9	HWX32012210238	Linkes Schild	29	HWX200011135	Kompressor
10	HWX321221173	Trennungsschild	30	HWX321221019	Stromschutzschild
11	HWX20013605	Druckregler Hochdruck	31	HWX32012210237	Gestell
12	HWX20003603	Druckregler Niedrigdruck	32	HWX321221176	Schaltkasten
13	HWX32012210241	ABS-Schild im oberen Bereich	33	HWX20003619	Relais
14	HWX20011418	Ventil mit 4 Wegen	34	HWX20003909	Klemmleiste mit 2 Anschlüssen
15	HWX20041446	Filter (Ø9.7 - Ø3.4)	35	HWX950531145	Elektronikkarte PC1000
16	HWX200014153	Valve Shrader	36	HWX40003901	Stromklemmleiste mit 5 Anschlüssen
17	HWX34061204	Verdunster	37	HWX200037006	Transformator 230V~/12V~
18	HWX200036005	Ausgabe-Sensor	38	HWX20003510	Kondensator Kompressor 60µF
19	HWX20003242	Temperatur-Sonde	39	HWX20009909	Kapillare
20	HWX20003242	Temperatur-Sonde			

## 6. ANHÄNGE (Fortsetzung)

---

### ECP 11

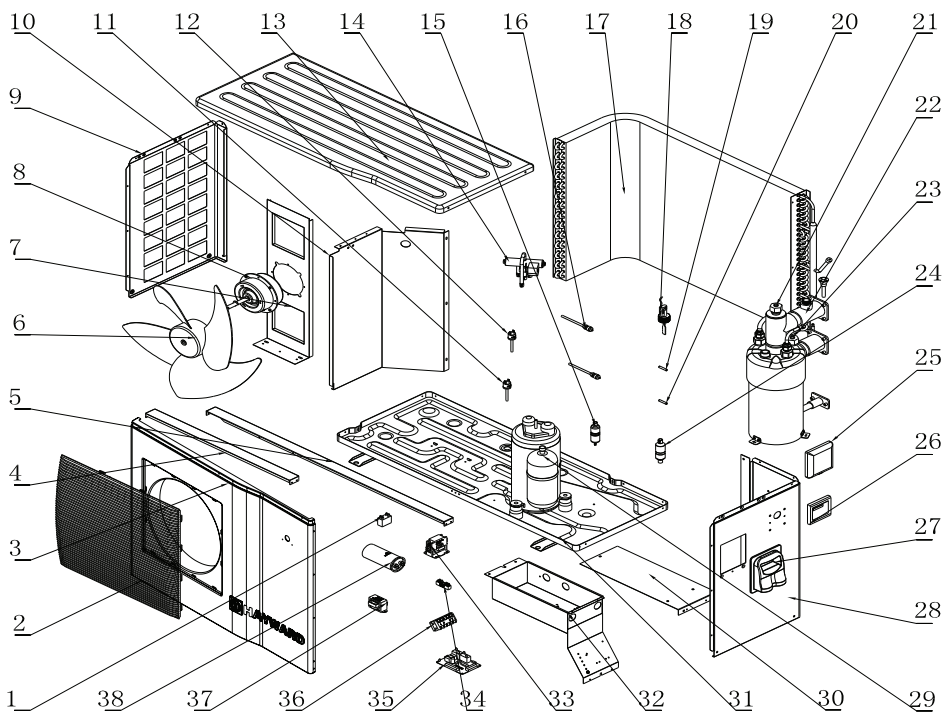

## 6. ANHÄNGE (Fortsetzung)

### ECP 11

Rep	Ref.	Bezeichnung	Rep	Ref.	Bezeichnung
1	HWX20003501	Kondensator Ventilator 3µF	21	HWX20003242	Temperatur-Sonde
2	HWX35122213	Gitter	22	HWX32121209	Titan/PVC--Kondensator
3	HWX32012210240	Schild ABS Vorne	23	HWX20003242	Temperatur-Sonde
4	HWX321221175	Aussteifung vorne	24	HWX20041445	Filter(Φ9.7-Φ4.2)
5	HWX321221018	Aussteifung Hinten	25	HWX20002111	Schutz des Kontrollgeräts
6	HWX35002701	Ventilatorblatt	26	HWX950531188	Kontrollgerät mit 7 Segmenten
7	HWX321221174	Motorträger	27	HWX32009220054	Handgriff
8	HWX34043301	Ventilationsmotor	28	HWX32012210238	Rechtes Schild
9	HWX32012210238	Linkes Schild	29	HWX200011134	Kompressor
10	HWX321221173	Trennungsschild	30	HWX321221019	Stromschutzschild
11	HWX20013605	Druckregler Hochdruck	31	HWX32012210237	Gestell
12	HWX20003603	Druckregler Niedrigdruck	32	HWX321221176	Schaltkasten
13	HWX32012210241	ABS-Schild im oberen Bereich	33	HWX20003619	Relais
14	HWX20011418	Ventil mit 4 Wegen	34	HWX20003909	Klemmleiste mit 2 Anschlüssen
15	HWX20041446	Filter (Ø9.7 - Ø3.4)	35	HWX950531145	Elektronikkarte PC1000
16	HWX200014153	Valve Shrader	36	HWX40003901	Stromklemmleiste mit 5 Anschlüssen
17	HWX321212002	Verdunster	37	HWX200037006	Transformator 230V~/12V~
18	HWX200036005	Ausgabe-Sensor	38	HWX20003505	Kondensator Kompressor 60µF
19	HWX20003242	Temperatur-Sonde	39	HWX20009909	Kapillare
20	HWX20003242	Temperatur-Sonde			

## 6. ANHÄNGE (Fortsetzung)

---

### ECP 13

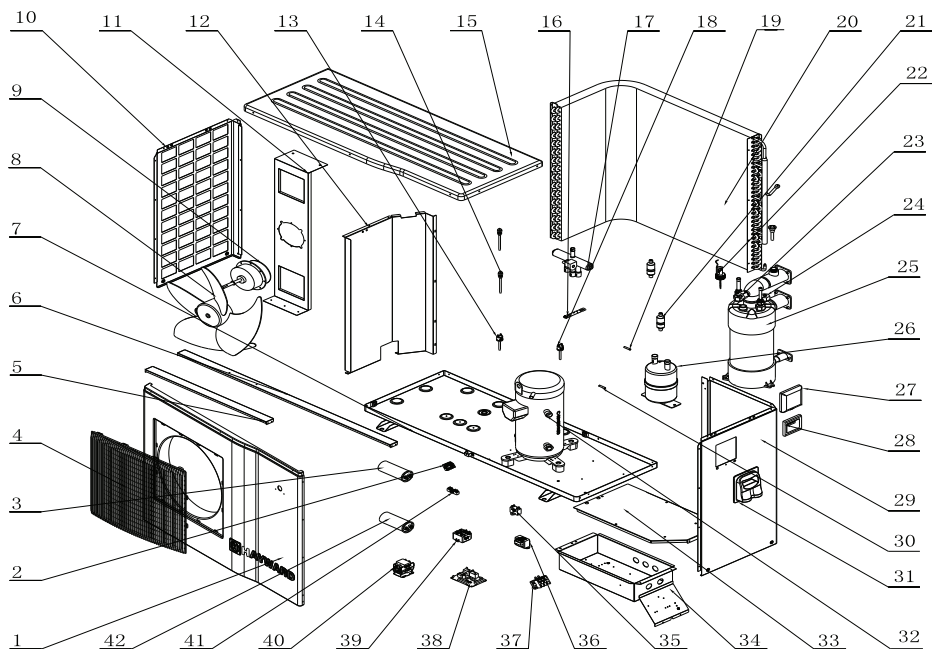



## 6. ANHÄNGE (Fortsetzung)

### ECP 13

Rep	Ref.	Bezeichnung	Rep	Ref.	Bezeichnung
1	HWX32009210196	Schild ABS Vorne	23	HWX20003242	Temperatur-Sonde
2	HWX20003933	Klemmleiste mit 3 Anschlüssen	24	HWX20003242	Temperatur-Sonde
3	HWX20003524	Kondensator-Start CPS 98µF	25	HWX32091206	Titan/PVC--Kondensator
4	HWX35122213	Gitter	26	HWX35001401	HWX35001401
5	HWX320921015	Aussteifung vorne	27	HWX20002111	Schutz des Kontrollgeräts
6	HWX320921149	Aussteifung Hinten	28	HWX950531188	HWX950531188
7	HWX32009210193	Gestell	29	HWX32009210194	Rechtes Schild
8	HWX35002701	Ventilatorblatt	30	HWX20003242	Temperatur-Sonde
9	HWX34043301	Ventilationsmotor	31	HWX32009220054	Handgriff
10	HWX320921145	Linkes Schild	32	HWX20011170	Kompressor
11	HWX320921147	Motorträger	33	HWX320921152	Stromschutzschild
12	HWX320921148	Trennungsschild	34	HWX320921151	Schaltkasten
13	HWX20013605	Druckregler Hochdruck	35	HWX20003501	Kondensator Ventilator 3µF
14	HWX200014153	Valve Shrader	36	HWX200037006	Transformator 230V~/12V~
15	HWX32009210197	ABS-Schild im oberen Bereich	37	HWX20003920	Klemmleiste mit 3 Anschlüssen
16	HWX20001489	Drosselung	38	HWX950531145	Elektronikkarte PC1000
17	HWX20011491	Ventil mit 4 Wegen	39	HWX20003676	Relais
18	HWX20003603	Druckregler Niedrigdruck	40	HWX200036007	Kompressor-Impulsgeber
19	HWX20003242	Temperatur-Sonde	41	HWX20003909	Klemmleiste mit 2 Anschlüssen
20	HWX351212001	Verdunster	42	HWX20003510	Kondensator Kompressor 60µF
21	HWX20041444	Filter (Ø9.7-Ø9.7)	43	HWX20009909	Kapillare
22	HWX200036005	Ausgabe-Sensor			

## 6. ANHÄNGE (Fortsetzung)

---

ECP 15

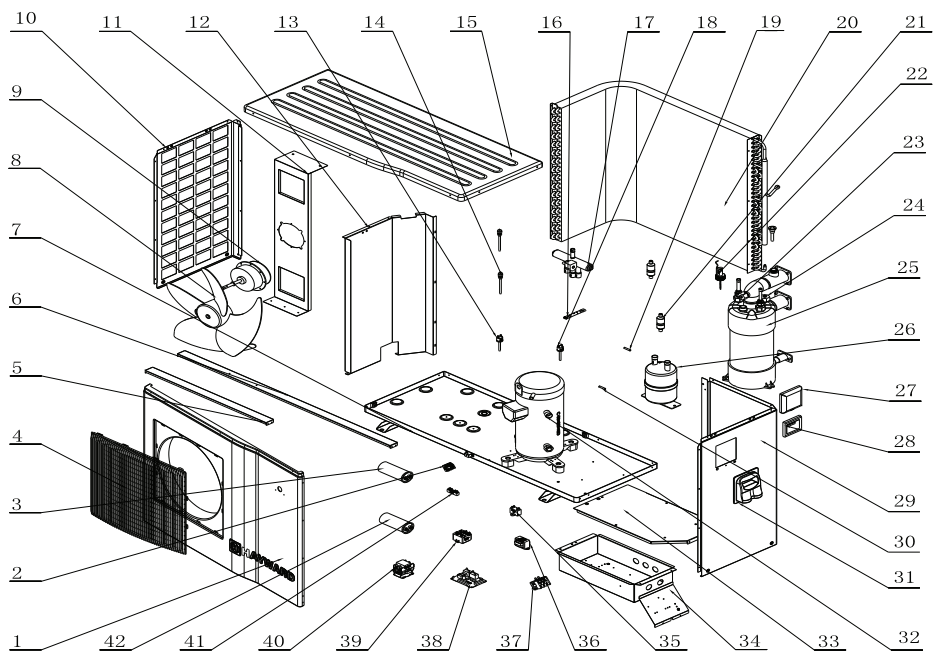

## 6. ANHÄNGE (Fortsetzung)

### ECP 15

Rep	Ref.	Bezeichnung	Rep	Ref.	Bezeichnung
1	HWX32009210196	Schild ABS Vorne	23	HWX20003242	Temperatur-Sonde
2	HWX20003933	Klemmleiste mit 3 Anschlüssen	24	HWX20003242	Temperatur-Sonde
3	HWX20003524	Kondensator-Start CPS 98µF	25	HWX32091206	Titan/PVC--Kondensator
4	HWX35122213	Gitter	26	HWX35001401	HWX35001401
5	HWX320921015	Aussteifung vorne	27	HWX20002111	Schutz des Kontrollgeräts
6	HWX320921149	Aussteifung Hinten	28	HWX950531188	HWX950531188
7	HWX32009210193	Gestell	29	HWX32009210194	Rechtes Schild
8	HWX35002701	Ventilatorblatt	30	HWX20003242	Temperatur-Sonde
9	HWX34043301	Ventilationsmotor	31	HWX32009220054	Handgriff
10	HWX320921145	Linkes Schild	32	HWX20011169	Kompressor
11	HWX320921147	Motorträger	33	HWX320921152	Stromschutzschild
12	HWX320921148	Trennungsschild	34	HWX320921151	Schaltkasten
13	HWX20013605	Druckregler Hochdruck	35	HWX20003501	Kondensator Ventilator 3µF
14	HWX200014153	Valve Shrader	36	HWX200037006	Transformator 230V~/12V~
15	HWX32009210197	ABS-Schild im oberen Bereich	37	HWX20003920	Klemmleiste mit 3 Anschlüssen
16	HWX20001489	Drosselung	38	HWX950531145	Elektronikkarte PC1000
17	HWX20011491	Ventil mit 4 Wegen	39	HWX20003676	Relais
18	HWX20003603	Druckregler Niedrigdruck	40	HWX200036007	Kompressor-Impulsgeber
19	HWX20003242	Temperatur-Sonde	41	HWX20003909	Klemmleiste mit 2 Anschlüssen
20	HWX351212001	Verdunster	42	HWX20003510	Kondensator Kompressor 60µF
21	HWX20041444	Filter (Ø9.7-Ø9.7)	43	HWX20009909	Kapillare
22	HWX200036005	Ausgabe-Sensor			

## 6. ANHÄNGE (Fortsetzung)

### 6.4 Leitfaden zur Fehlerbeseitigung



**Einige Tätigkeiten müssen von einem offiziell zugelassenen Techniker durchgeführt werden.**

Störung	Fehler-Codes	Beschreibung	Lösung
Fehler bei Wassereingangs-Sensor	P01	Der Messfühler ist geöffnet oder es liegt ein Kurzschluss vor.	Überprüfen oder Ersetzen des Meßfühlers.
Fehler Wasser-Ausgangs-Sensor	P02	Der Messfühler ist geöffnet oder es liegt ein Kurzschluss vor.	Überprüfen oder Ersetzen des Meßfühlers.
Fehler äußerer Temperatur-Sensor	P04	Der Messfühler ist geöffnet oder es liegt ein Kurzschluss vor.	Überprüfen oder Ersetzen des Meßfühlers.
Fehler Entfrostsungs-Sensor	P05	Der Messfühler ist geöffnet oder es liegt ein Kurzschluss vor.	Überprüfen oder Ersetzen des Meßfühlers.
Hochdruckschutz	E01	Zu hoher Druck im Gefrier-Kreislauf oder zu geringer Wasserausgabedruck oder Verdunster verstopft oder Luftaustritt zu gering.	Überprüfen des Niederdruck-Druckgebers und des Drucks im Gefrier-Kreislauf zwecks Aufspürens eines eventuell vorhandenen Lecks. Überprüfen der Wasser- oder Luft-Ausgabe. Überprüfen der einwandfreien Funktion des Ausgabe-Kontrollelements. Überprüfen der Öffnung der Ventile für Wasser-Eingang und-Ausgang. Überprüfen der Bypass-Regelung.
Niederdruck-Schutz	E02	Überprüfen des zu niedrigen Gefrierkreislaufs oder des zu geringen Luftaustritts oder verstopften Verdunsters.	Überprüfen des Niederdruck-Druckreglers und des Drucks im Gefrierkreislauf, um ein eventuell vorhandenes Leck aufzuspüren. Reinigen der Verdunsteroberfläche. Überprüfen der Geschwindigkeit der Ventilator-Rotation. Überprüfen der ungehinderten Luftzirkulation durch den Verdunster.
Fehler beim Ausgabe-Sensor	E03	Unzureichender Wasser-Ausgang oder Kurzschluss oder Defekt des Fühlers	Überprüfen Sie zwecks Aufspürens der Fehler die Wasser-Ausgabe, überprüfen Sie die Filterpumpe und den Austritts-Fühler.
Zu großer Temperatur-unterschied zwischen Wasser-Ausgang und Wasser-Eingang	E06	Mengenmäßiger Wasseraustritt ist unzureichend, Wasserdruck-Unterschied zu gering/ zu hoch.	Überprüfung der Wasser-Ausgabe bzw. Verstopfung des Systems.
Schutz Frostschutzmittel Kalt-Modus	E07	Ausströmende Wassermenge zu gering.	Überprüfen der Wasser-Ausgabe oder des Sensors für die Temperatur des ausströmenden Wassers.
Problem der Informationsübermittlung	E08	Fehler bei der LED-Kontrolleinheit oder des PCB-Anschlusses.	Überprüfung des Kabelanschlusses.
Schutz Frostschutzmittel von Stufe 1	E19	Temperatur von Umgebung und einströmendem Wasser zu gering.	Stopp der Wärmepumpe und Entleeren des Kondensators. Risiko des Einfrierens.
Schutz Frostschutzmittel von Stufe 2	E29	Temperatur der Umgebung und einströmendes Wasser zu gering.	Stopp der Wärmepumpe und Entleeren des Kondensators. Risiko des Einfrierens.

## 6. ANHÄNGE (Fortsetzung)

---

### 6.5 Garantie

#### GARANTIEVORAUSSETZUNGEN

Für sämtliche HAYWARD-Produkte bestehen innerhalb von zwei Jahren ab Kauf des Produkts Garantien hinsichtlich sämtlicher Fertigungsfehler oder Materialmängel. Bei jedem Antrag auf Garantie muss der Nachweis des Kaufs, einschließlich des Belegs zum Kaufdatum, erbracht werden. Wir bitten Sie also um Aufbewahrung Ihrer Rechnung.

Die HAYWARD-Garantie, die grundsätzlich ganz im Ermessen von HAYWARD liegt, beschränkt sich auf die Reparatur oder den Ersatz, hinsichtlich fehlerhafter Produkte, sofern sie sachgemäß benutzt wurden, nämlich in Übereinstimmung mit den im Benutzerleitfaden befindlichen Vorschriften; das Produkt darf keinesfalls verändert worden sein und darf ausschließlich mit den Bauteilen und Einzelteilen von HAYWARD benutzt werden. Die Garantie erstreckt sich nicht auf Beschädigungen aufgrund von Frost und Einwirkungen chemischer Substanzen.

Ausgeschlossen von der Garantie sind sämtliche sonstigen Kosten (Transport, Arbeitstätigkeit...).

HAYWARD kann nicht haftbar gemacht werden für direkte oder indirekte Schäden, die sich aufgrund falscher Montage, fehlerhaften Anschlusses oder der falschen Funktion des Produkts ergeben.

Falls Sie einen Garantieantrag stellen, eine Reparatur beantragen oder ein Produkt austauschen möchten, so wenden Sie sich bitte an Ihren Händler. Ausgeschlossen ist eine Material-Rücksendung an unser Werk ist ohne unsere vorherige schriftliche Zustimmung.

Die Verschleißteile unterliegen nicht der Garantie.

# EASY TEMP

## ZWEMBAD WARMTEPOMP

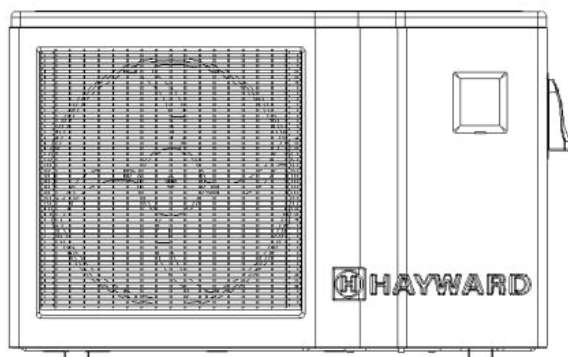

**Installatie- en bedieningshandleiding**

# OVERZICHT

---

<b>1. Voorwoord</b>	<b>1</b>
<hr/>	
<b>2. Technische kenmerken</b>	<b>2</b>
2.1 Technische gegevens van de warmtepomp	2
2.2 Werkgebied	3
2.3 Afmetingen	4
<hr/>	
<b>3. Installatie en aansluiting</b>	<b>5</b>
3.1 Flow chart	5
3.2 Warmtepomp	5
3.3 Hydraulische aansluiting	6
3.4 Elektrische aansluiting	7
3.5 Eerste start	8
3.6 Afstelling van het waterdebiet	10
<hr/>	
<b>4. Gebruikersinterface</b>	<b>11</b>
4.1 Algemene voorstelling	11
4.2 Afstelling van de klok	13
4.3 Afstelling van de timerfunctie	13
4.4 Keuze van de werkingsmodus : verwarming of afkoeling	14
4.5 Afstelling en weergave van de ingestelde waarde	15
4.6 Vergrendeling en ontgrendeling van de gebruikersinterface	15
<hr/>	
<b>5. Onderhoud en overwintering</b>	<b>16</b>
5.1 Onderhoud	16
5.2 Overwintering	16
<hr/>	
<b>6. Bijlagen</b>	<b>17</b>
6.1 Bedradingsschema's	17
6.2 Aansluitingen voorrang verwarming	22
6.3 Gedemonteerde aanzichten en onderdelen	23
6.4 Herstelgids	33
6.5 Garantie	34

Aandachtig lezen en bewaren voor latere raadpleging.

Dit document moet aan de eigenaar van het zwembad overhandigd worden en door hem op een veilige plaats bewaard worden.

# 1. VOORWOORD

---

We danken u voor de aanschaf van deze Easy Temp zwembadwarmtepomp. Dit product werd ontworpen volgens strikte productienormen om aan het vereiste kwaliteitsniveau te voldoen. Deze handleiding bevat alle noodzakelijke informatie over de installatie, het oplossen van problemen en het onderhoud. Lees deze handleiding aandachtig vooraleer u de eenheid opent of er onderhoudsoperaties op uitvoert. De producent van dit product zal in geen geval aansprakelijk zijn in geval van verwonding van een gebruiker of beschadiging van de eenheid ten gevolge van fouten tijdens de installatie, het oplossen van problemen of een onnodig onderhoud. Het is van het grootste belang om de instructies die in deze handleiding gegeven worden op elk ogenblik te volgen. De eenheid moet door gekwalificeerd personeel geïnstalleerd worden.

- Herstellingen moeten door gekwalificeerd personeel uitgevoerd worden.
- Alle elektrische aansluitingen moeten door een gekwalificeerde vakbekwame elektricien uitgevoerd worden volgens de normen die van kracht zijn in het land waar de installatie uitgevoerd wordt vgl. § 3.4.
- Het onderhoud en de verschillende operaties moeten uitgevoerd worden volgens de aanbevolen frequentie en momenten zoals in deze handleiding bepaald wordt.
- Gebruik enkel originele wisselstukken.
- Elke niet nageleefde aanbeveling doet de garantie vervallen.
- Deze warmtepomp verwarmt het zwembadwater en houdt een constante temperatuur aan, gebruik deze niet voor andere doeleinden.

Nadat u deze handleiding hebt gelezen, legt u deze best op een gemakkelijk te bereiken plaats voor later gebruik.

Waarschuwing voor kinderen / personen met verminderd lichamelijk vermogen: Dit toestel is niet bedoeld om gebruikt te worden door personen (met name kinderen) van wie de fysische, zintuiglijke of intellectuele vermogens beperkt zijn of door personen die geen ervaring of kennis hebben, tenzij deze onder toezicht staan of instructies hebben gekregen over het gebruik van het toestel van een persoon die verantwoordelijk is voor hun veiligheid.

Dit product bevat fluorhoudende broeikasgassen die kaderen in het Kyoto-protocol.

Soort koelmiddel: R410A

GWP-waarde<sup>(1)</sup>: 1975

Periodieke inspecties van koelmiddellekken kunnen vereist zijn volgens de Europese of plaatselijke wetgeving. Contacteer uw plaatselijke verdeler voor meer informatie.

---

(1) Globale verwarmingscapaciteit



## 2. TECHNISCHE KENMERKEN

### 2.1 Technische gegevens van de warmtepomp

Model	EASY TEMP	ECP 06	ECP 08	ECP 11	ECP 13	ECP 15
Warmtevermogen *	kW BTU/h	5,5 18785	8 27322	11 37566	13 46105	15 51228
Elektrisch vermogen	kW	1,17	1,8	2,43	3	3,13
Werkingstroom *	A	5,19	7,91	11,81	14,5	16
Elektrische voeding	V Ph/Hz	230 V ~ 1/50 Hz	230 V ~ 1/50 Hz	230 V ~ 1/50 Hz	230 V ~ 1/50 Hz	230 V ~ 1/50 Hz
Kaliber zekering type aM	A	8 aM	10 aM	16 aM	20 aM	20 aM
Hoofdzekering D-curve	A	8 D	10 D	16 D	20 D	20 aM
Aantal compressoren		1	1	1	1	1
Soort compressor		Roterend	Roterend	Roterend	Scroll	Scroll
Aantal ventilatoren		1	1	1	1	1
Ventilatorvermogen	W	50	120	120	120	120
Rotatiesnelheid van de ventilator	TPM	770	850	850	850	120
Richting van de ventilator		Horizontaal	Horizontaal	Horizontaal	Horizontaal	Horizontaal
Geluidsdrukniveau (op 1 meter)	dB(A)	47	51	54	56	56
Hydraulische aansluiting	mm	50	50	50	50	50
Waterdebiet	m <sup>3</sup> /h	2,3	3,0	4,5	5,3	50
Drukverval op het water (max)	kPa	5,4	8,9	19,2	5,2	39,9
Netto-afmetingen van de eenheid (L/B/H)	mm	895/375/545	1035/415/650	1035/415/650	1136/440/870	1136/440/870
Afmetingen van de verpakte eenheid (L/B/H)	mm	970/430/710	1120/480/810	1180/480/810	1230/510/1020	1230/510/1020
Nettogewicht / gewicht van de verpakte eenheid	kg	45/56	54/68	60/74	95/115	117/128



\*Waarde +/- 5% in de volgende omstandigheden: Buitentemperatuur = 24C (75F) / HR=62% / Temperatuur van het zwembad=27C (80F)

## 2. TECHNISCHE KENMERKEN (vervolg)

---

### 2.2 Werkgebied

Gebruik de warmtepomp in het volgende temperatuur- en vochtigheidsbereik om een veilige en efficiënte werking te garanderen.

	Verwarmingsmodus 	Afkoelingsmodus 
Buitentemperatuur	+2C ~ +35C	+7C ~ +43C
Watertemperatuur	+12C ~ +40C	+8C ~ +40C
Relatieve vochtigheid	< 80%	< 80%
Afstelbereik afgestelde waarde	+15C ~ +40C	+8C ~ +35C



***Indien de temperatuur of de vochtigheid niet met deze omstandigheden overeenkomen, kunnen de veiligheidsvoorzieningen in werking treden en kan de warmtepomp niet meer werken.***

## 2. TECHNISCHE KENMERKEN (vervolg)

### 2.3 Afmetingen

Modellen : ECP06 / ECP08 / ECP11 / ECP13 / ECP15

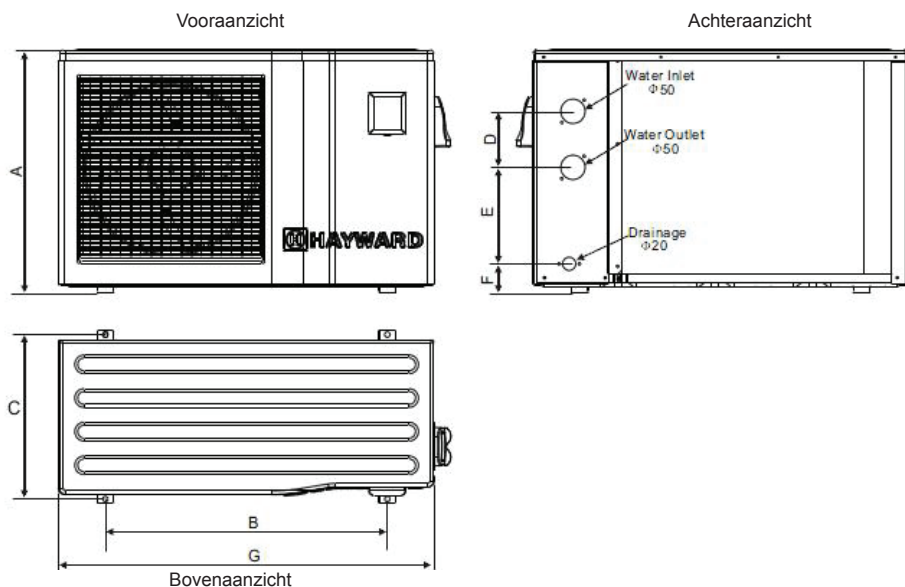

Eenheid: mm

Model	ECP06	ECP08 ECP11	ECP13 ECP15
A	540	648	866
B	571	755	840
C	400	440	470
D	140	150	150
E	258	258	330
F	66	77	80
G	860	1004	1114

## 3. INSTALLATIE EN AANSLUITING

### 3.1 Flow chart

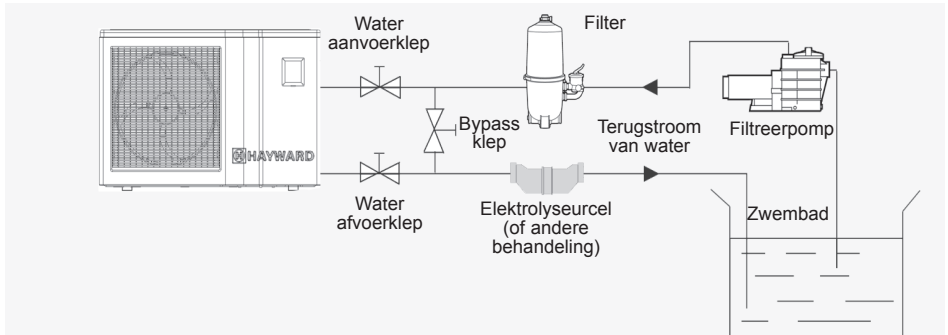

Noot : \_De warmtepomp wordt zonder enige behandlungs- of filtreeruitrusting geleverd. De elementen die op de chart staan zijn onderdelen die de installateur moet leveren.

### 3.2 Warmtepomp



**Plaats de warmtepomp buiten en niet in een afgesloten technische ruimte.**

**Plaatsing onder een afdak waarbij de hieronder voorgeschreven minimumafstanden nageleefd moeten worden om elk gevaar op hercirculatie van lucht en verminderde algemene prestaties van de warmtepomp te vermijden.**

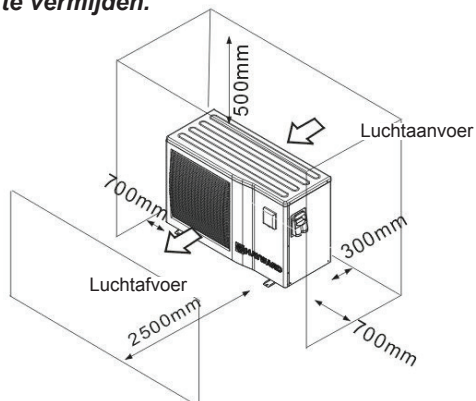

### 3. INSTALLATIE EN AANSLUITING (vervolg)

---



*Installeer de warmtepomp bij voorkeur op een afzonderlijke betonplaat of een daartoe voorziene bevestigingssteun en monteer de warmtepomp op de geleverde silentblocs (schroeven en ringetjes niet bijgeleverd).*

*Maximum installatieafstand tussen de warmtepomp en het zwembad 15 meter.*

*Totale lengte heen-terug van de hydraulische leidingen 30 meter.*

*Isoleer de hydraulische leidingen die zich aan de oppervlakte en in de ondergrond bevinden.*

#### 3.3 Hydraulische aansluiting

De warmtepomp wordt geleverd met twee verbindingstukken van 50 mm diameter. Gebruik een pvc-buis voor hydraulische leiding  $\varnothing$  50 mm. Sluit de wateraanvoer van de warmtepomp aan de leiding aan die van de filtergroep komt en sluit dan de waterafvoer van de warmtepomp aan de waterleiding aan die naar het bassin loopt (zie onderstaand schema).

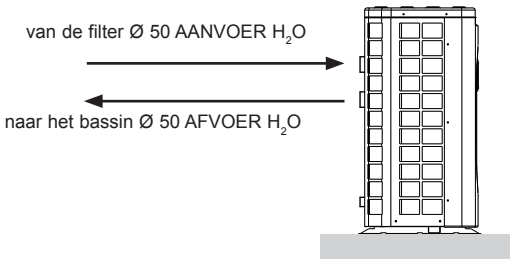

Installeer een bypassklep tussen de aanvoer en de afvoer van de warmtepomp.



*Als er een automatische verdeler of een elektrolyseur gebruikt wordt, moet deze achter de warmtepomp geïnstalleerd worden om de titaniumcondensator te beschermen tegen een te hoge concentratie van het chemische product.*



*Zorg ervoor dat u de bypassklep en de geleverde verbindingstukken correct installeert op de wateraanvoer en -afvoer van de eenheid om de waterontluchting tijdens de winter te vereenvoudigen en er de toegang of de demontage van te vergemakkelijken voor het onderhoud.*

### 3. INSTALLATIE EN AANSLUITING (vervolg)

#### 3.4 Elektrische aansluiting



**De elektrische installatie en de bekabeling van deze uitrusting moeten in overeenstemming zijn met de plaatselijk geldende installatieregels.**

F	NF C15-100	GB	BS7671:1992
D	DIN VDE 0100-702	EW	EVHS-HD 384-7-702
A	ÖVE 8001-4-702	H	MSZ 2364-702/1994/MSZ 10-553 1/1990
E	UNE 20460-7-702 1993, RECBT ITC-BT-31 2002	M	MSA HD 384-7-702.S2
IRL	Wiring Rules + IS HD 384-7-702	PL	PN-IEC 60364-7-702:1999
I	CEI 64-8/7	CZ	CSN 33 2000 7-702
LUX	384-7.702 S2	SK	STN 33 2000-7-702
NL	NEN 1010-7-702	SLO	SIST HD 384-7-702.S2
P	RSIUEE	TR	TS IEC 60364-7-702



**Controleer dat de beschikbare elektrische voeding en de netfrequentie overeenkomen met de vereiste werkingsstroom waarbij rekening gehouden moet worden met de specifieke plaats van het toestel en de stroom die noodzakelijk is om elk toestel dat met hetzelfde circuit verbonden is te voeden.**

**ECP 06 230 V~ +/- 10 % 50 HZ 1 fase**

**ECP 08 230 V~ +/- 10 % 50 HZ 1 fase**

**ECP 11 230 V~ +/- 10 % 50 HZ 1 fase**

**ECP 13 230 V~ +/- 10 % 50 HZ 1 fase**

**ECP 15 230 V~ +/- 10 % 50 HZ 1 fase**

**Volg het overeenkomstige bijgevoegde bekabelingsschema.**

**De aansluitingsdoos bevindt zich aan de rechterkant van de eenheid.**

**Drie verbindingen zijn bestemd voor de elektrische voeding en twee voor de besturing van de filterpomp (Besturingssysteem).**

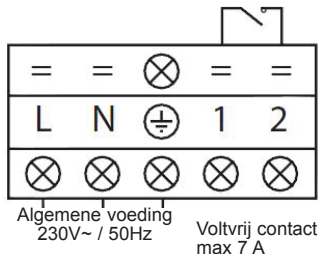

### 3. INSTALLATIE EN AANSLUITING (vervolg)

---



*De elektrische voedingslijn moet op passende wijze voorzien zijn van een zekeringsbeveiliging van het type motorvoeding (aM) of hoofdzekering D-curve en van een differentiële hoofdzekering 30mA (zie onderstaande tabel).*

Modellen		ECP 06	ECP 08	ECP 11	ECP 13	ECP 15
Elektrische voeding	V/Ph/ Hz	230 V~ 1/50 Hz	230 V~ 1/50 Hz	230 V~ 1/50 Hz	230 V~ 1/50 Hz	230 V~ 1/50 Hz
Kaliber zekering type aM	A	8 aM	10 aM	16 aM	20 aM	20 aM
Hoofdzekering D-curve	A	8 D	10 D	16 D	20 D	20 D



*Zorg er altijd voor de hoofdvoeding af te zetten vooraleer u de elektrische regelkast opent.*

#### 3.5 Eerste start

Startprocedure - eens de installatie beëindigd is, volgt u de volgende stappen in de aangegeven volgorde:

- 1) Doe de ventilator met de hand draaien om te controleren dat hij vrij kan draaien en dat de schroef correct op de motoras vastgemaakt is.
- 2) Vergewis er u van dat de eenheid correct met de hoofdvoeding verbonden is (zie het bijgevoegde bekabelingsschema).
- 3) Schakel de filtreerpomp in.
- 4) Controleer dat alle waterkleppen open zijn en dat het water naar de eenheid loopt vooraleer in verwarmings- of afkoelingsmodus over te gaan.
- 5) Controleer dat de spuilleiding van de condensaten correct is vastgemaakt en geen enkele verstopping vertoont.
- 6) Schakel de elektrische voeding van de eenheid in en druk daarna de Start/ Stop-knop in  op het bedieningspaneel.

### 3. INSTALLATIE EN AANSLUITING (vervolg)

---

- 7) Vergewis er u van dat er geen enkele ALARMcode weergegeven wordt wanneer de eenheid op ON staat (zie herstellingsgids).
- 8) Leg het waterdebiet vast met de bypassklep (zie §3.6 en 2.1), zoals respectievelijk voorzien voor elk model, om een temperatuurverschil Aanvoer/Afvoer te verkrijgen van 2C.
- 9) Na enkele minuten werking, controleren dat de afgevoerde lucht van de eenheid afgekoeld is (tussen 5 en 10).
- 10) Aangezien de eenheid in werking is, schakelt u de filtererpomp uit. De eenheid moet automatisch stilvallen en de foutcode E03 weergeven.
- 11) Laat de eenheid en de zwembadpomp 24 uur op 24 draaien totdat de gewenste watertemperatuur bereikt is. Wanneer de aanvoertemperatuur van het water de ingestelde waarde bereikt, stopt de eenheid. De eenheid start dan automatisch opnieuw (zolang de zwembadpomp ingeschakeld is) indien de temperatuur van het zwembad minstens 0.5C lager is dan de ingestelde temperatuur.

**Debietregelaar** - De eenheid is uitgerust met een debietregelaar die de warmtepomp inschakelt wanneer de filtererpomp van het zwembad in werking is en deze uitschakelt wanneer de filtererpomp buiten werking is. Bij gebrek aan water wordt de alarmcode E03 op de regelaar weergegeven (zie § 6.4).

**Vertraging** - de eenheid integreert een vertraging van 3 minuten om de onderdelen van het besturingscircuit te beschermen, alle onstabieleit weg te werken bij het herstarten en elke interferentie op het niveau van het relais uit te schakelen. Dankzij deze vertraging herstart de eenheid automatisch ongeveer 3 minuten na elke onderbreking van het besturingscircuit. Zelfs een stroomonderbreking van korte duur activeert de opstartvertraging.



## 3. INSTALLATIE EN AANSLUITING (vervolg)

### 3.6 Afstelling van het waterdebiet

Wanneer de warmtepomp draait en de aan- en afvoerkleppen van het water open zijn, stelt u de "bypass"klep bij om een verschil te verkrijgen van 2C tussen de aanvoer- en afvoertemperatuur van het water (zie flow chart § 3.1). U kan de afstelling controleren door de aanvoer- (T02) / afvoer (T03) temperaturen rechtstreeks op het bedieningspaneel af te lezen door onderstaande procedure te volgen.

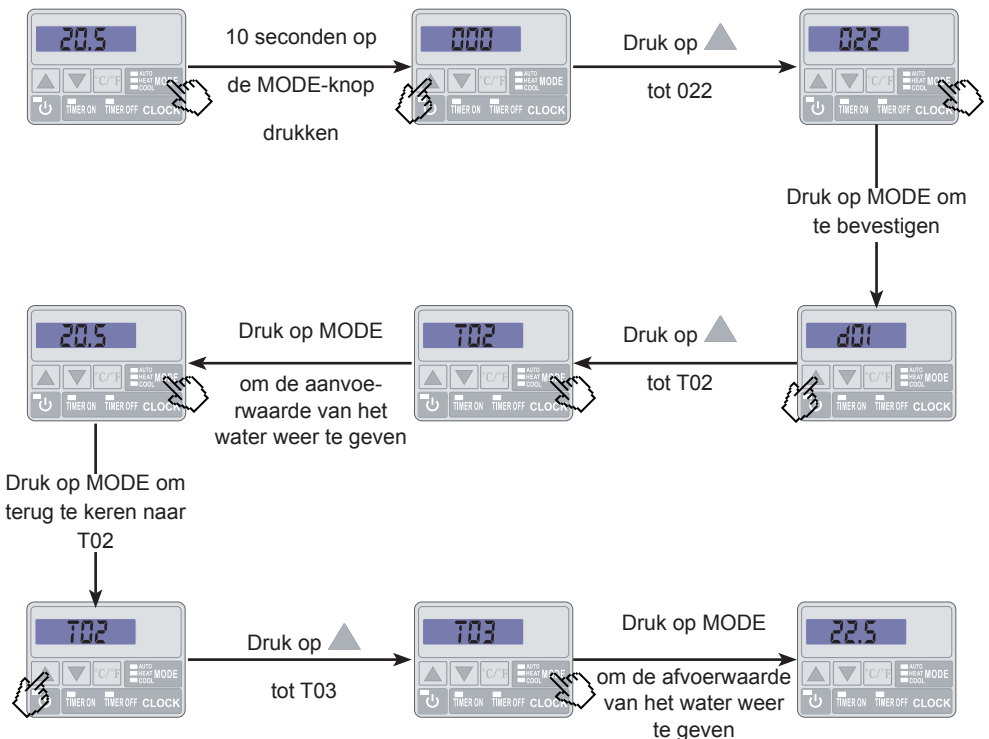

Daarna stelt u uw bypass af om een verschil van 2C tussen T03 en T02 te verkrijgen ( $T03-T02 = \Delta T = 2$ ).

Druk 2 maal op  om het menu te verlaten

Noot : De opening van de bypassklep brengt een lager debiet teweeg waardoor  $\Delta T$  stijgt.  
De sluiting van de bypassklep brengt een hoger debiet teweeg waardoor  $\Delta T$  daalt.

## 4. GEBRUIKERSINTERFACE

---

### 4.1 Algemene voorstelling

De warmtepomp is uitgerust met een elektronisch bedieningspaneel, elektrisch aangesloten en in de fabriek reeds afgesteld in verwarmingsmodus.

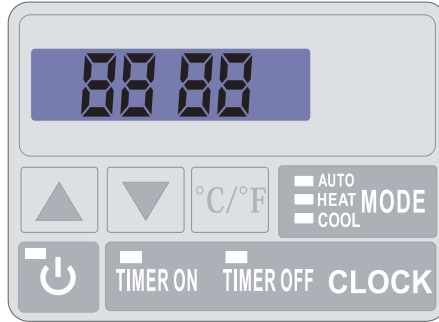

#### Legende

-  **COOL** Symbol Afkoelmodus
-  **HEAT** Symbol Verwarmingsmodus
-  **AUTO** Automatische modus
-  **CLOCK** Afstelling uur en timer
-  **MODE** Knop selectie en afstelling
-  Start/Stopknop en terug/bevestiging
-  Naar beneden scrollen
-  Naar boven scrollen
-  **TIMER ON** Afstelling werkingsuur
-  **TIMER OFF** Afstelling uitschakeluur

## 4. GEBRUIKERSINTERFACE (vervolg)

---

### OFF-modus

Wanneer de warmtepomp in waakstand (OFF-modus) staat, worden het uur en de werkingsmodus op het scherm van de regelaar weergegeven.

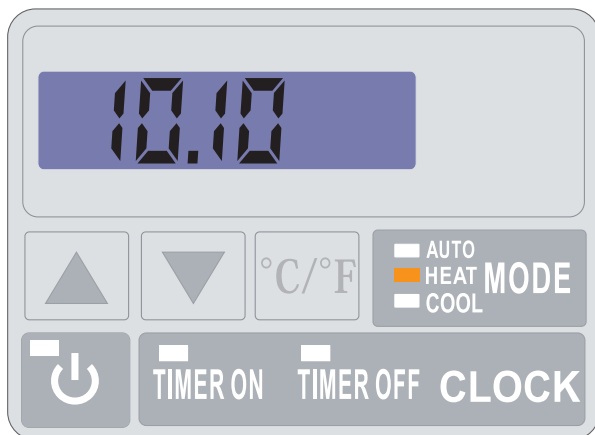

### ON-modus



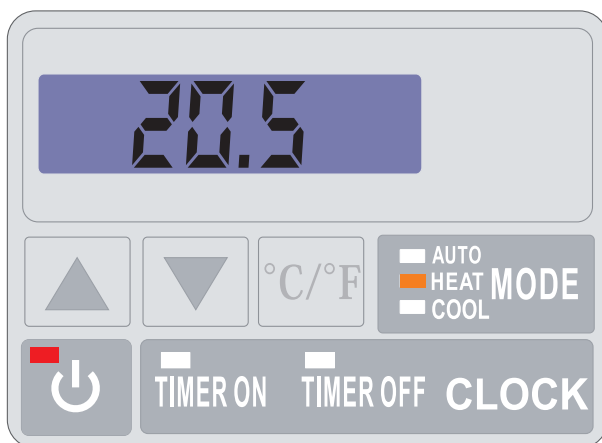

Wanneer de warmtepomp in werking of in regeling is (ON-modus) gaat het rode lichtje van de werkingsknop branden en wordt de aanvoertemperatuur van het water op het scherm weergegeven.



## 4. GEBRUIKERSINTERFACE (vervolg)

---

### 4.2 Afstelling van de klok





De afstelling van de klok kan in ON- of in OFF-modus gebeuren. Druk op «CLOCK», de display knippert, druk dan op «CLOCK», de uren knipperen. Stel het uur in met de pijltjes  of  druk daarna nogmaals op «CLOCK» om de minuten te selecteren. Stel de minuten in met de pijltjes  of . Druk op «CLOCK» om te bevestigen. Het scherm keert terug naar zijn vorige toestand.

Noot: De afstellingen worden met de «CLOCK» knop opgeslagen of automatisch opgeslagen indien er gedurende 5 seconden geen enkele knop geactiveerd werd.

### 4.3 Afstelling van de timerfunctie

Deze functie moet afgesteld worden wanneer u uw warmtepomp gedurende een kortere periode wil laten werken dan deze die door de filterklok werd ingesteld. Zo kan u een uitgestelde start en een voortijdige stop programmeren of gewoonweg een werkingsuurblok verbieden (bijvoorbeeld 's nachts).





#### Programmering Start (Timer ON) / Werking

- 1) Druk op «Timer ON», het uur knippert.
- 2) Druk op «Timer ON» om het uur met de knoppen af te stellen  .
- 3) Druk op «Timer ON» om de minuten met de knoppen af te stellen  .

De afstellingen worden met de knop «Timer ON» opgeslagen of automatisch opgeslagen indien er gedurende 5 seconden geen enkele knop geactiveerd werd.

Een groen verklikkerlampje geeft aan dat de timer geactiveerd is.

#### Programmering Stop (Timer OFF) / Stop



- 1) Druk op «Timer OFF», het uur knippert.
- 2) Druk op «Timer OFF» om het uur af te stellen met de knoppen  .
- 3) Druk op «Timer OFF» om de minuten af te stellen met de knoppen  .

De afstellingen worden met de knop «Timer OFF» opgeslagen of automatisch opgeslagen indien er gedurende 5 seconden geen enkele knop geactiveerd werd. Een rood verklikkerlampje geeft aan dat de timer geactiveerd is.

## 4. GEBRUIKERSINTERFACE (vervolg)

---

### Verwijdering van de timers (Timer ON en OFF) / Stop en Start

- 1) Druk op «Timer ON», «Timer ON» knippert.
- 2) Druk  om de programmering te verwijderen.
- 3) Druk «Timer OFF», «Timer OFF» knippert.
- 4) Druk  om de programmering te verwijderen.

### 4.4 Keuze van de werkingsmodus : verwarming, afkoeling of automatisch.

#### In “OFF”- of “ON”-modus

Druk op de knop «MODE» om van de afkoelmodus (groen verklikkerlichtje) naar de verwarmingsmodus (oranje verklikkerlichtje) naar de automatische modus (rood verklikkerlichtje) te gaan.





## 4. GEBRUIKERSINTERFACE (vervolg)

---



### 4.5 Afstelling en weergave van de ingestelde waarde (gewenste watertemperatuur)

In "OFF"- en "ON"-modus

Druk de knoppen  of  in om de gewenste ingestelde waarde te bepalen. De afstelling is tot op 0,5 C nauwkeurig.



*Het is aanbevolen de temperatuur van 30C nooit te overschrijden om slijtage van de liners te vermijden.*

Noot : \_In werking of bij stilstand volstaat het de knop  of  in te drukken om de ingestelde waarde weer te geven of te wijzigen.

### 4.6 Vergrendeling en ontgrendeling van het touch screen

Druk 5 seconden op de Start/Stopknop  totdat er een signaal weerklinkt. De knoppen worden uitgeschakeld.

Om te ontgrendelen drukt u 5 seconden op  totdat er een signaal weerklinkt.

De knoppen worden weer ingeschakeld.

## 5. ONDERHOUD EN OVERWINTERING

---

### 5.1 Onderhoud

Deze onderhoudsoperaties moeten 1 maal per jaar uitgevoerd worden om de levensduur en de goede werking van de warmtepomp te garanderen.

- Reinig de verdamper met een zachte borstel of met een lucht- of waterstraal (**Opgelet: gebruik in geen geval een hogedrukreiniger**).
- Controleer of de condensaten goed wegvloeien.
- Controleer of de hydraulische en elektrische aansluitingen goed vastgeschroefd zijn



*Voor elke onderhoudsoperatie moet de warmtepomp van elke elektrische stroombron afgekoppeld worden. De onderhoudsoperaties mogen enkel door gekwalificeerd personeel worden uitgevoerd dat gemachtigd is om met koelvloeistoffen te werken.*

- Controleer de hydraulische dichtheid van de condensor.

### 5.2 Overwintering

- Schakel de warmtepomp in "OFF"-modus.
- Schakel de voeding van de warmtepomp uit.
- Leeg de condensor door aftapping om elk gevaar op beschadiging te voorkomen. (Groot gevaar op vorst).
- Sluit de bypassklep en schroef de aanvoer/afvoer- verbindingstukken los.
- Verwijder zoveel mogelijk stagnerende restwater van de condensator met een luchtpistool.
- Sluit aanvoer en afvoer van het water op de warmtepomp af om te vermijden dat er vreemde voorwerpen in terechtkomen.
- Dek de warmtepomp met een overwinteringshoes af (niet meegeleverd).



*Elke schade die veroorzaakt wordt door een slechte overwintering doet de garantie vervallen.*

# 6. BIJLAGEN

## 6.1 Bedradingschema's

ECP 06

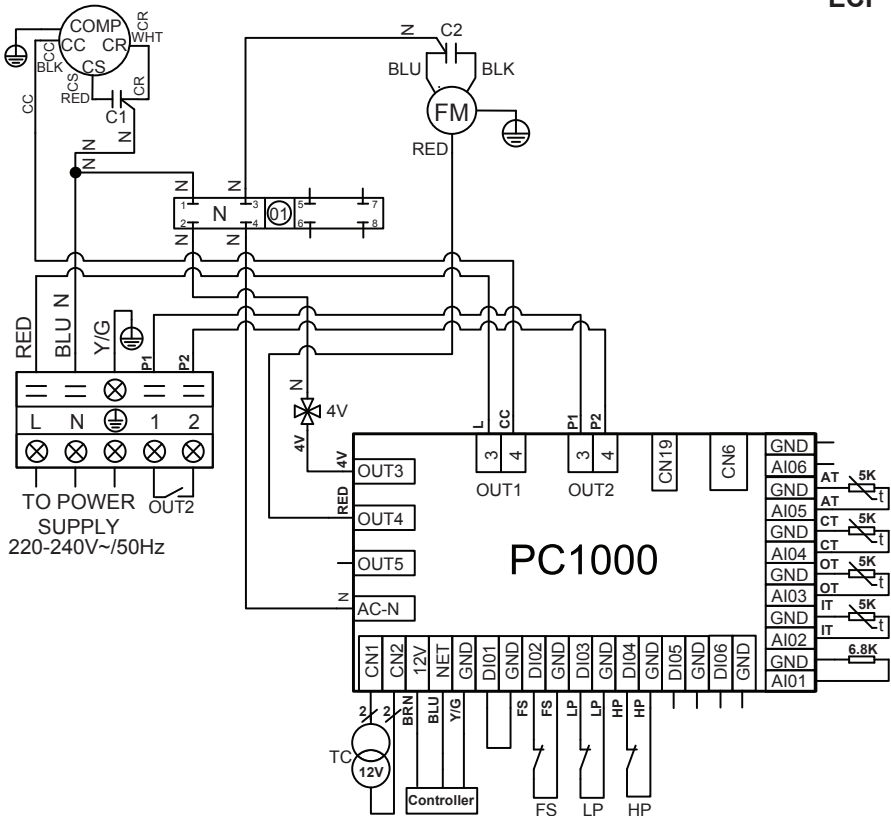

**OPMERKINGEN:**

- AT : LUCHTTEMPERATUURSONDE
- COMP : COMPRESSOR
- CT : VERDAMPERTEMPORATUURSONDE
- FM: VENTILATORMOTOR
- FS : DETECTOR VAN AANWEZIGHEID VAN WATER
- HP: DRUKREGELAAR HOGE DRUK
- IT: TEMPERATUURSONDE WATERAANVOER

- LP: DRUKREGELAAR LAGE DRUK
- OT: TEMPERATUURSONDE WATERAFVOER
- TC : TRANSFORMATOR 230V~/ 12V~
- 4V: 4-WEGKLEP
- C1 : CONDENSATOR COMPRESSOR
- C2 : CONDENSATOR VENTILATOR
- OUT2 : VOLTVRIJ CONTACT MAX 7 A



## 6. BIJLAGEN (vervolg)

ECP 08

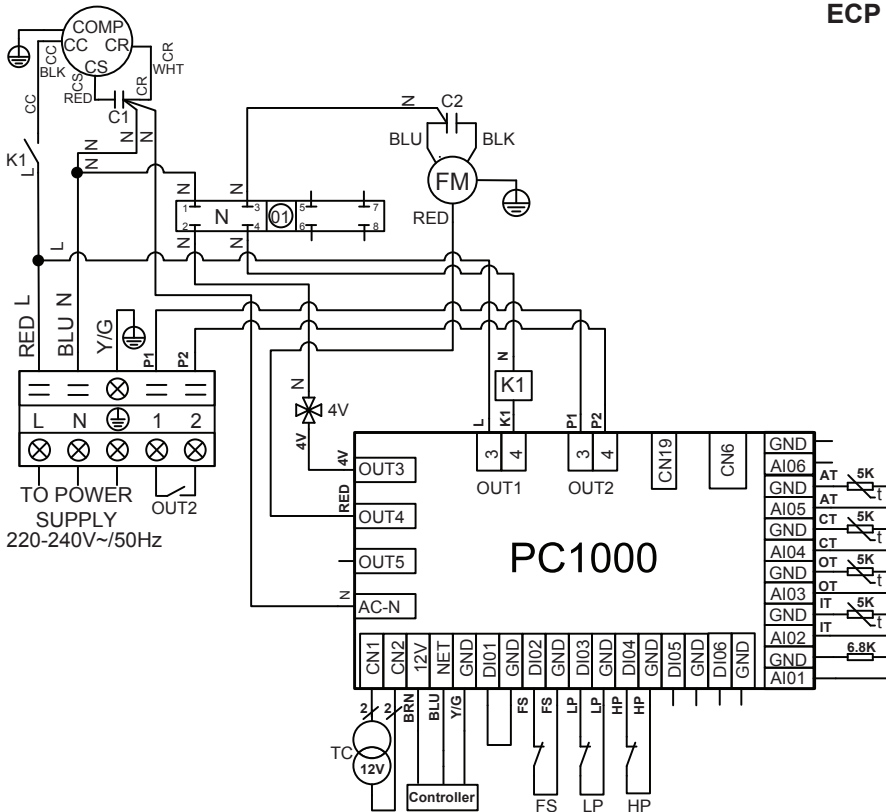

### OPMERKINGEN:

AT : LUCHTTEMPERATUURSONDE

COMP : COMPRESSOR

CT : VERDAMPERTEMPORATUURSONDE

FM: VENTILATORMOTOR

FS : DETECTOR VAN AANWEZIGHEID VAN WATER

HP: DRUKREGELAAR HOGE DRUK

IT: TEMPERATUURSONDE WATERAANVOER

OT: TEMPERATUURSONDE WATERAFVOER

TC : TRANSFORMATOR 230V~ / 12V~

4V: 4-WEGKLEP

K1 : COMPRESSORRELAIS

C1 : CONDENSATOR COMPRESSOR

C2 : CONDENSATOR VENTILATOR

OUT2 : VOLTURIJ CONTACT MAX 7 A

LP: DRUKREGELAAR LAGE DRUK

# 6. BIJLAGEN (vervolg)

ECP 11

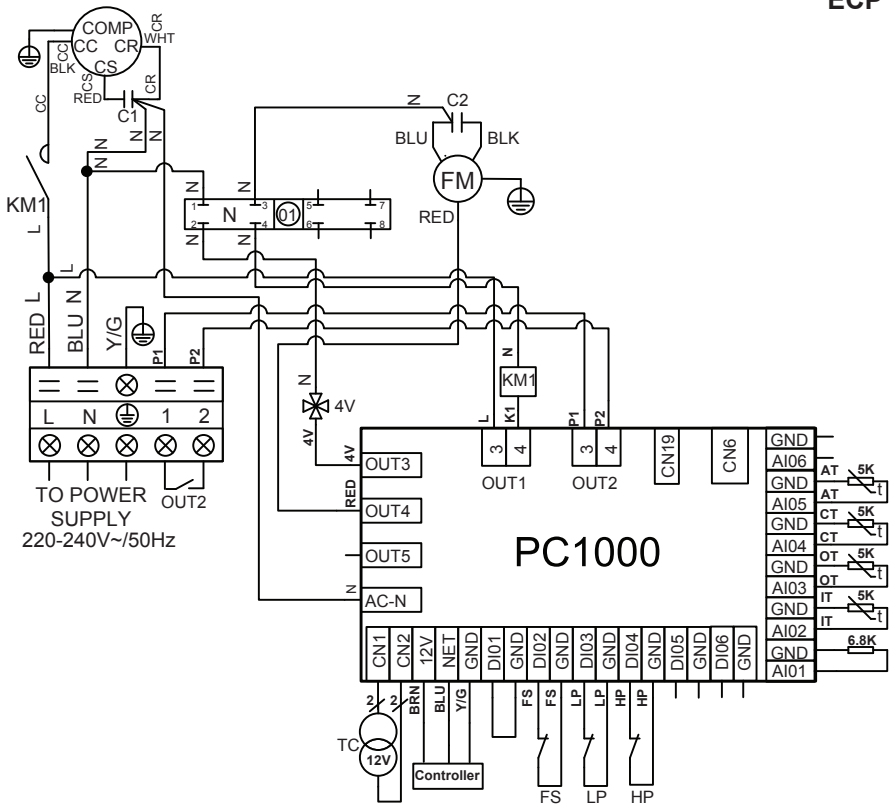

**OPMERKINGEN:**

- AT : LUCHTTEMPERATUURSONDE
- COMP : COMPRESSOR
- CT : VERDAMPERTEMPERATUURSONDE
- FM: VENTILATORMOTOR
- FS : DETECTOR VAN AANWEZIGHEID VAN WATER
- HP: DRUKREGELAAR HOGE DRUK
- IT: TEMPERATUURSONDE WATERAANVOER
- LP: DRUKREGELAAR LAGE DRUK
- OT: TEMPERATUURSONDE WATERAFVOER

- TC : TRANSFORMATOR 230V~ / 12V~
- 4V: 4-WEGKLEP
- KM1: VERMOGENSRELAIS COMPRESSOR
- C1:CONDENSATOR COMPRESSOR
- C2:CONDENSATOR VENTILATOR
- OUT2 : VOLTVRIJ CONTACT MAX 7 A

# 6. BIJLAGEN (vervolg)

ECP 13

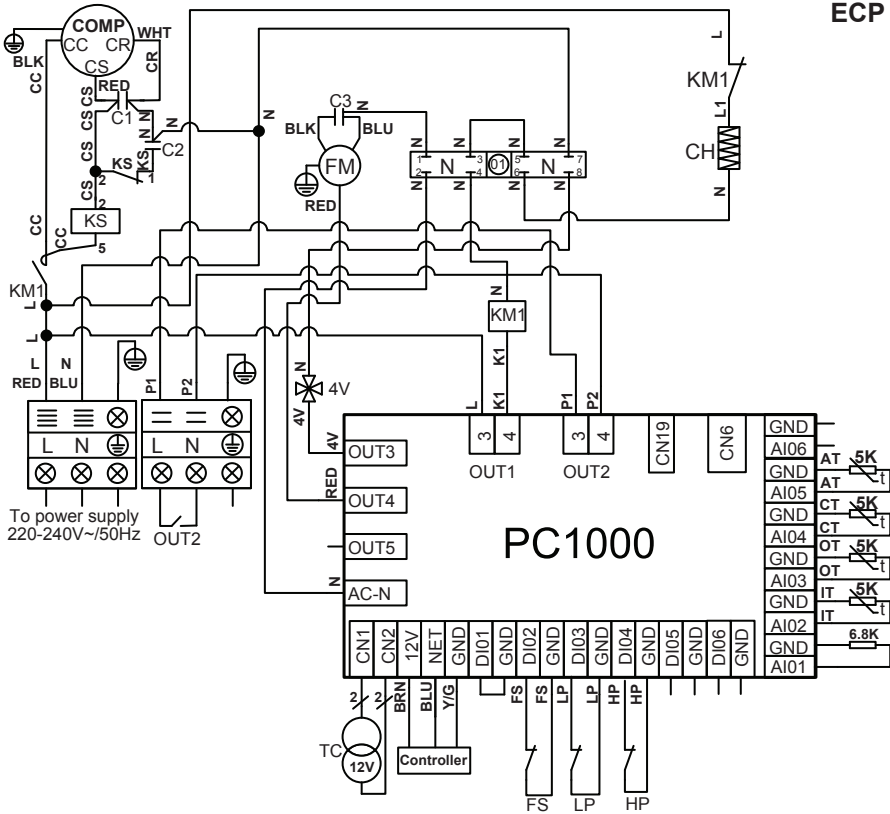

**OPMERKINGEN:**

- AT : LUCHTTEMPERATUURSONDE
- COMP : COMPRESSOR
- CH: CARTERWEERSTAND
- CT: VERDAMPERTEMPORATUURSONDE
- FM: VENTILATORMOTOR
- FS : DETECTOR VAN AANWEZIGHEID VAN WATER
- HP: DRUKREGELAAR HOGE DRUK
- IT: TEMPERATUURSONDE WATERAANVOER

- KS: SPOEL VAN HET STARTRELAIS VAN DE COMPRESSOR
- LP: DRUKREGELAAR LAGE DRUK
- OT: TEMPERATUURSONDE WATERAFVOER
- TC : TRANSFORMATOR 230V~ / 12V~
- 4V: 4-WEGKLEP
- KM1 : VERMOGENSRELAIS COMPRESSOR
- C1 : PERMANENTE CONDENSATOR
- C2 : STARTCONDENSATOR
- OUT2 : VOLTVRIJ CONTACT MAX 7 A

# 6. BIJLAGEN (vervolg)

ECP 15

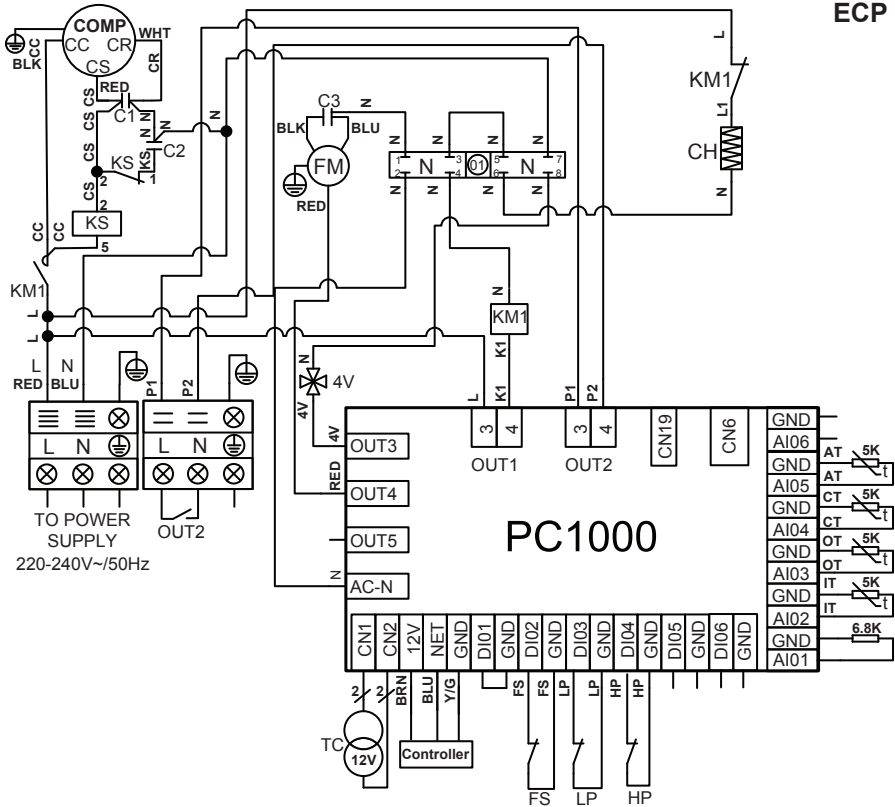

**OPMERKINGEN:**

- AT : LUCHTTEMPERATUURSONDE
- COMP : COMPRESSOR
- CH: CARTERWEERSTAND
- CT : VERDAMPERTEMPORATUURSONDE
- FM: VENTILATORMOTOR
- FS : DETECTOR VAN AANWEZIGHEID VAN WATER
- HP: DRUKREGELAAR HOGE DRUK
- IT: TEMPERATUURSONDE WATERAANVOER

- KS: SPOEL VAN HET STARTRELAIS VAN DE COMPRESSOR
- LP: DRUKREGELAAR LAGE DRUK
- OT: TEMPERATUURSONDE WATERAFVOER
- TC : TRANSFORMATOR 230V~ / 12V~
- 4V: 4-WEGLKLEP
- KM1 : VERMOGENSRELAIS COMPRESSOR
- C1 : PERMANENTE CONDENSATOR
- C2 : STARTCONDENSATOR
- OUT2 : VOLTURIJ CONTACT MAX 7 A

## 6. BIJLAGEN (vervolg)

### 6.2 Aansluitingen voorrang verwarming eenfasige Pomp

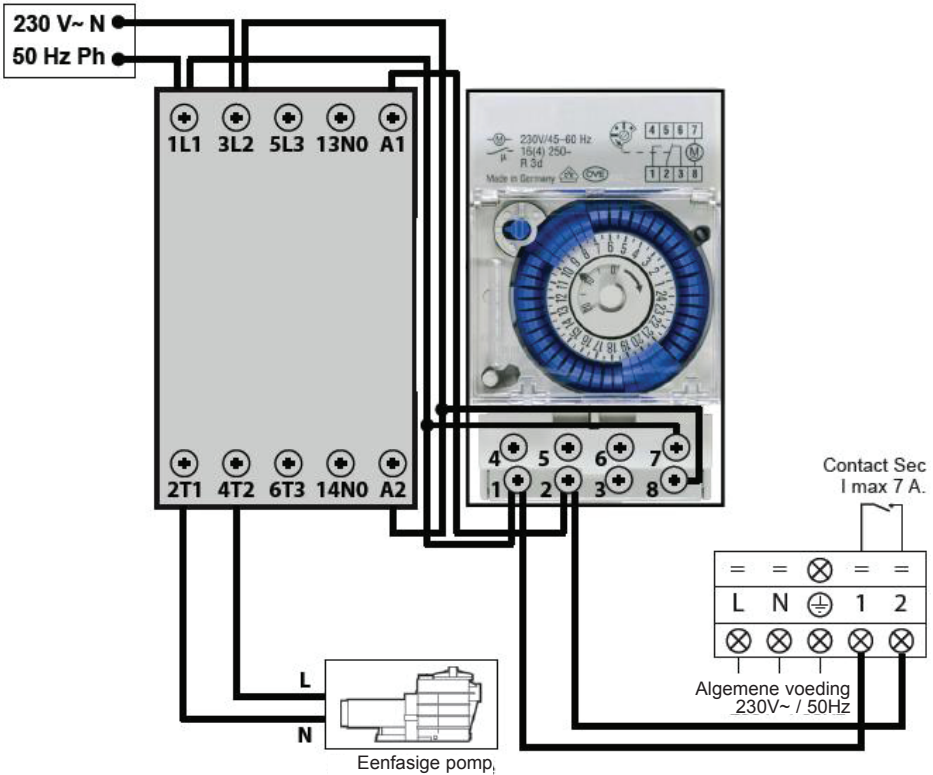

De zuilen 1-2 leveren een spanningvrij contact, zonder polariteit 230 V~ / 50 Hz.

Sluit de zuilen 1 en 2 met kabels aan zoals op het schema hierboven is aangegeven zodat de werking van de filterpomp wordt ingesteld op een cyclus van 2 minuten per uur als de temperatuur van het bassin lager is dan aanbevolen.

 De voeding van de filterpomp nooit direct aansluiten op de zuilen 1 en 2.



## 6. BIJLAGEN (vervolg)

---

### 6.3 Gedemonteerde aanzichten en onderdelen

ECP 06

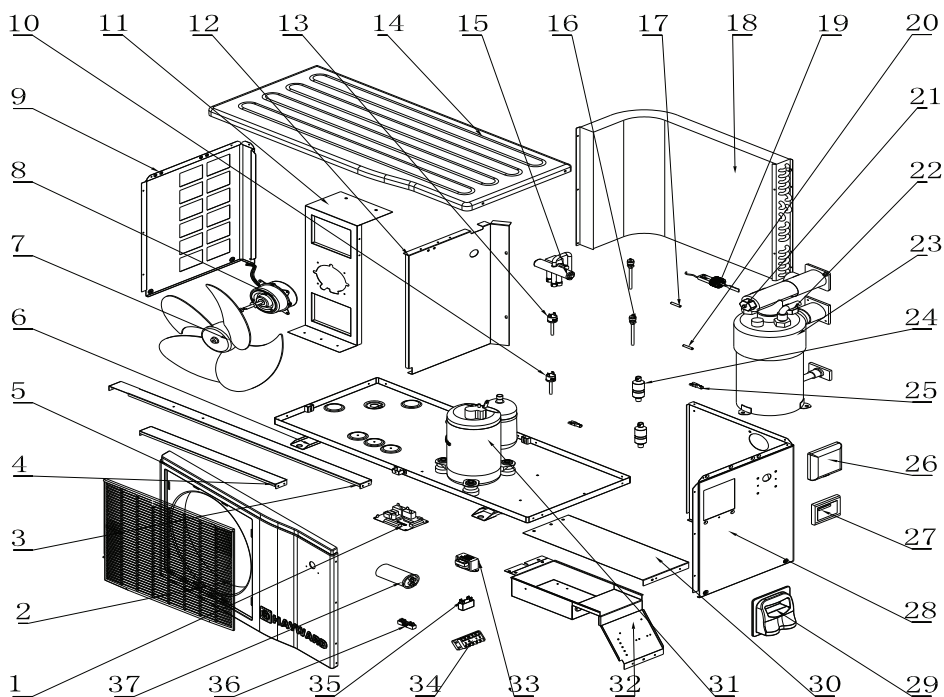

## 6. BIJLAGEN (vervolg)

---

### ECP06

Rep	Ref.	Benaming	Rep	Ref.	Benaming
1	HWX950531145	Elektronische kaart PC1000	20	HWX20003242	Temperatuursonde
2	HWX35252208	Rooster	21	HWX20003242	Temperatuursonde
3	HWX322521062	Verstijver Achter	22	HWX20003242	Temperatuursonde
4	HWX322521063	Verstijver Voor	23	HWX35251210	Titaancondensator/pvc
5	HWX32025210084	ABS-paneel Voor	24	HWX20041444	Filter (Ø9.7-Ø9.7)
6	HWX32025210081	Frame	25	HWX200014068	Capillairschakelaar
7	HWX34012701	Ventilatorschroefblad	26	HWX20002111	Controllerbeveiliging
8	HWX34013301	Ventilatormotor	27	HWX950531188	7 segmentencontroller
9	HWX32025210083	Linkerpaneel	28	HWX32025210082	Rechterpaneel
10	HWX20003603	Drukregelaar lage druk	29	HWX32009220054	Greep
11	HWX322521061	Motorsteun	30	HWX322521064	Elektrisch beveiligingspaneel
12	HWX322521059	Afscheidingspaneel	31	HWX200011006	Compressor
13	HWX20013605	Drukregelaar hoge druk	32	HWX322521006	HWX322521006
14	HWX32025210085	ABS-paneel bovenaan	33	HWX200037006	Transformator 230V~/12V~
15	HWX20011418	4-wegklep	34	HWX40003901	Elektrisch aansluitblok 5 aansluitingen
16	HWX200014153	Shrader klep	35	HWX20003506	Condensator ventilator 2µF
17	HWX20003242	Temperatuursonde	36	HWX20003909	Aansluitblok 2 aansluitingen
18	HWX40001230	Verdamper	37	HWX20003504	Condensator compressor 35µF
19	HWX200036005	Debietdetector	38	HWX20009910	Capillair

## 6. BIJLAGEN (vervolg)

---

### ECP 08

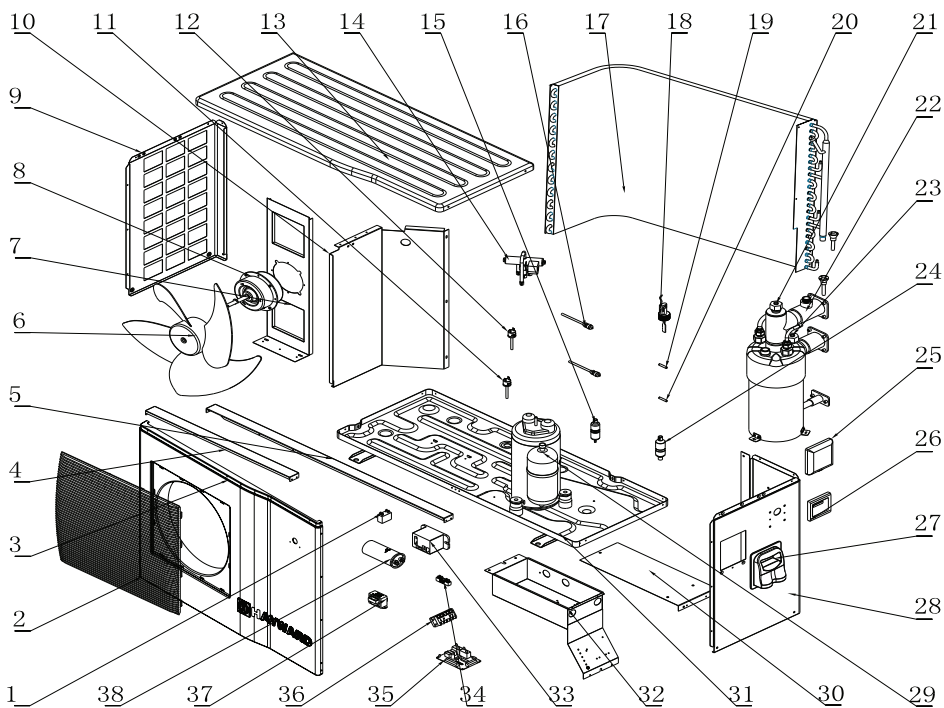



## 6. BIJLAGEN (vervolg)

### ECP 08

Rep	Ref.	Benaming	Rep	Ref.	Benaming
1	HWX20003501	Condensator ventilator 3 $\mu$ F	21	HWX20003242	Temperatuursonde
2	HWX35122213	Rooster	22	HWX32081205	Titaancondensator/pvc
3	HWX32012210240	ABS-paneel Voor	23	HWX20003242	Temperatuursonde
4	HWX321221175	Verstijver Voor	24	HWX20041445	Filter( $\Phi$ 9.7- $\Phi$ 4.2)
5	HWX321221018	Verstijver Achter	25	HWX20002111	Controllerbeveiliging
6	HWX35002701	Ventilatorschroefblad	26	HWX950531188	7 segmentencontroller
7	HWX321221174	Motorsteun	27	HWX32009220054	Greep
8	HWX34043301	Ventilatormotor	28	HWX32012210238	Rechterpaneel
9	HWX32012210238	Linkerpaneel	29	HWX200011135	Compressor
10	HWX321221173	Afscheidingspaneel	30	HWX321221019	Elektrisch beveiligingspaneel
11	HWX20013605	Drukregelaar hoge druk	31	HWX32012210237	Frame
12	HWX20003603	Drukregelaar lage druk	32	HWX321221176	Elektriciteitskast
13	HWX32012210241	ABS-paneel bovenaan	33	HWX20003619	Relais
14	HWX20011418	4-wegklep	34	HWX20003909	Aansluitblok 2 aansluitingen
15	HWX20041446	Filter ( $\Phi$ 9.7 - $\Phi$ 3.4)	35	HWX950531145	Elektronische kaart PC1000
16	HWX200014153	Shrader klep	36	HWX40003901	Elektrisch aansluitblok 5 aansluitingen
17	HWX34061204	Verdamper	37	HWX200037006	Transformator 230V~/12V~
18	HWX200036005	Debietdetector	38	HWX20003510	Condensator compressor 60 $\mu$ F
19	HWX20003242	Temperatuursonde	39	HWX20009909	Capillair
20	HWX20003242	Temperatuursonde			

## 6. BIJLAGEN (vervolg)

---

### ECP 11

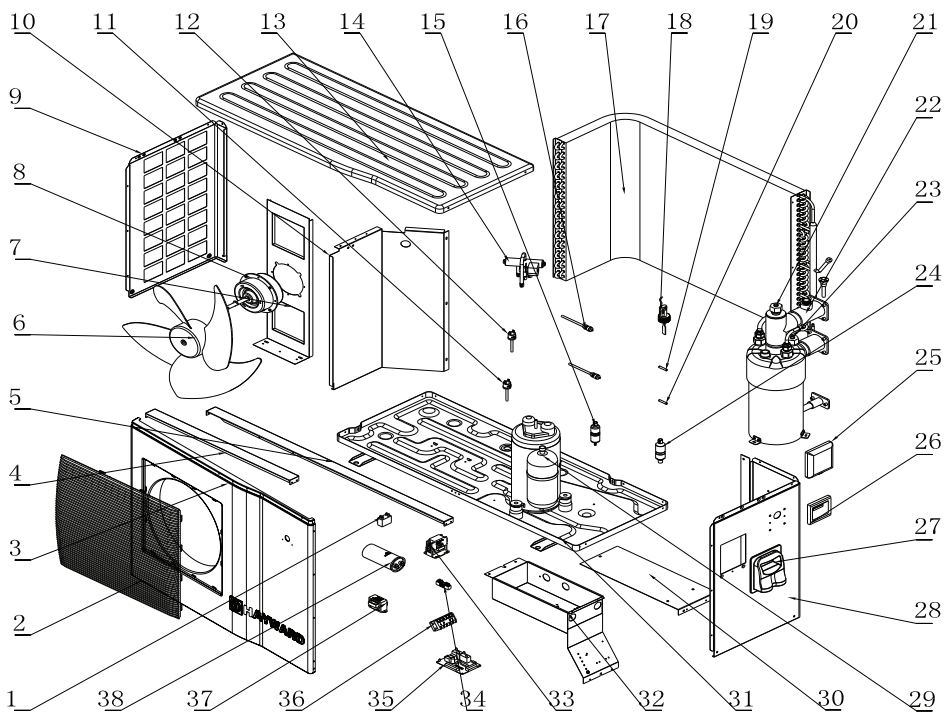

## 6. BIJLAGEN (vervolg)

### ECP 11

Rep	Ref.	Benaming	Rep	Ref.	Benaming
1	HWX20003501	Condensator ventilator 3 $\mu$ F	21	HWX20003242	Temperatuursonde
2	HWX35122213	Rooster	22	HWX32121209	Titaancondensator/pvc
3	HWX32012210240	ABS-paneel Voor	23	HWX20003242	Temperatuursonde
4	HWX321221175	Verstijver Voor	24	HWX20041445	Filter( $\Phi$ 9.7- $\Phi$ 4.2)
5	HWX321221018	Verstijver Achter	25	HWX20002111	Controllerbeveiliging
6	HWX35002701	Ventilatorschroefblad	26	HWX950531188	7 segmentencontroller
7	HWX321221174	Motorsteun	27	HWX32009220054	Greep
8	HWX34043301	Ventilatormotor	28	HWX32012210238	Rechterpaneel
9	HWX32012210238	Linkerpaneel	29	HWX200011134	Compressor
10	HWX321221173	Afscheidingspaneel	30	HWX321221019	Elektrisch beveiligingspaneel
11	HWX20013605	Drukregelaar hoge druk	31	HWX32012210237	Frame
12	HWX20003603	Drukregelaar lage druk	32	HWX321221176	Elektriciteitskast
13	HWX32012210241	ABS-paneel bovenaan	33	HWX20003619	Relais
14	HWX20011418	4-wegklep	34	HWX20003909	Aansluitblok 2 aansluitingen
15	HWX20041446	Filter ( $\Phi$ 9.7 - $\Phi$ 3.4)	35	HWX950531145	Elektronische kaart PC1000
16	HWX200014153	Shrader klep	36	HWX40003901	Elektrisch aansluitblok 5 aansluitingen
17	HWX321212002	Verdamper	37	HWX200037006	Transformator 230V~/12V~
18	HWX200036005	Debietdetector	38	HWX20003505	Condensator compressor 60 $\mu$ F
19	HWX20003242	Temperatuursonde	39	HWX20009909	Capillair
20	HWX20003242	Temperatuursonde			

## 6. BIJLAGEN (vervolg)

---

### ECP 13

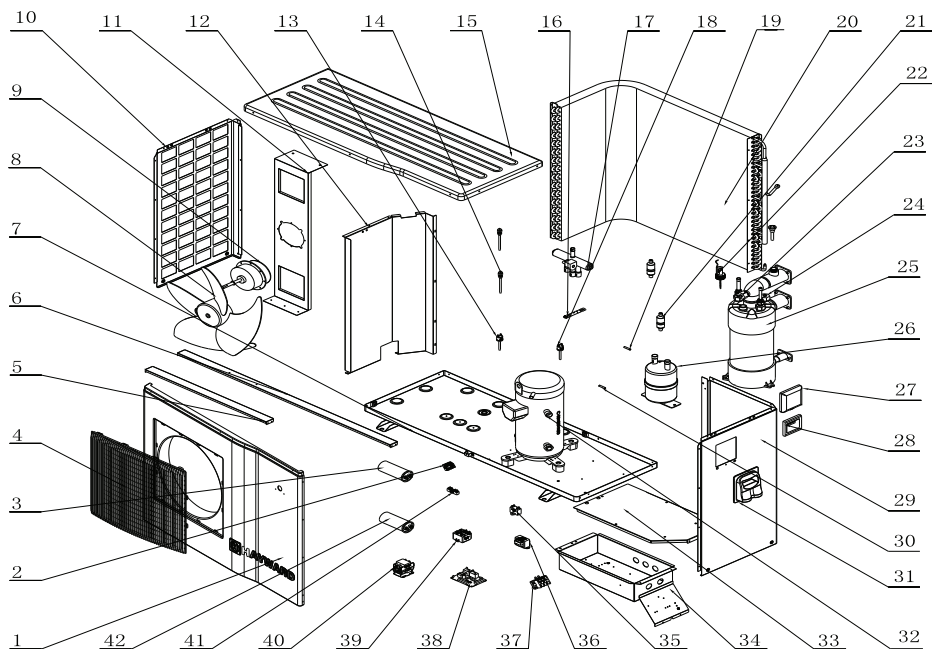

## 6. BIJLAGEN (vervolg)

### ECP 13

Rep	Ref.	Benaming	Rep	Ref.	Benaming
1	HWX32009210196	ABS-paneel Voor	23	HWX20003242	Temperatuursonde
2	HWX20003933	Aansluitblok 3 aansluitingen	24	HWX20003242	Temperatuursonde
3	HWX20003524	Condensator start CPS 98µF	25	HWX32091206	Titaancondensator/pvc
4	HWX35122213	Rooster	26	HWX35001401	Accumulator
5	HWX320921015	Verstijver Voor	27	HWX20002111	Controllerbeveiliging
6	HWX320921149	Verstijver Achter	28	HWX950531188	7 segmentencontroller
7	HWX32009210193	Frame	29	HWX32009210194	Rechterpaneel
8	HWX35002701	Ventilatorschroefblad	30	HWX20003242	Temperatuursonde
9	HWX34043301	Ventilatormotor	31	HWX32009220054	Greep
10	HWX32009210195	Linkerpaneel	32	HWX20011170	Compressor
11	HWX320921147	Motorsteun	33	HWX320921152	Elektrisch beveiligingspaneel
12	HWX320921148	Afscheidingspaneel	34	HWX320921151	Elektriciteitskast
13	HWX20013605	Drukregelaar hoge druk	35	HWX20003501	Condensator ventilator 3µF
14	HWX200014153	Shrader klep	36	HWX200037006	Transformator 230V~/12V~
15	HWX32009210197	ABS-paneel bovenaan	37	HWX20003920	Aansluitblok 3 aansluitingen
16	HWX20001489	Reductor	38	HWX950531145	Elektronische kaart PC1000
17	HWX20011491	4-wegklep	39	HWX20003676	Relais
18	HWX20003603	Drukregelaar lage druk	40	HWX200036007	Relais compressor
19	HWX20003242	Temperatuursonde	41	HWX20003909	Aansluitblok 2 aansluitingen
20	HWX351212001	Verdamper	42	HWX20003510	Condensator compressor 60µF
21	HWX20041444	Filter (Ø9.7-Ø9.7)	43	HWX20009909	Capillair
22	HWX200036005	Debietdetector			

## 6. BIJLAGEN (vervolg)

---

### ECP 15

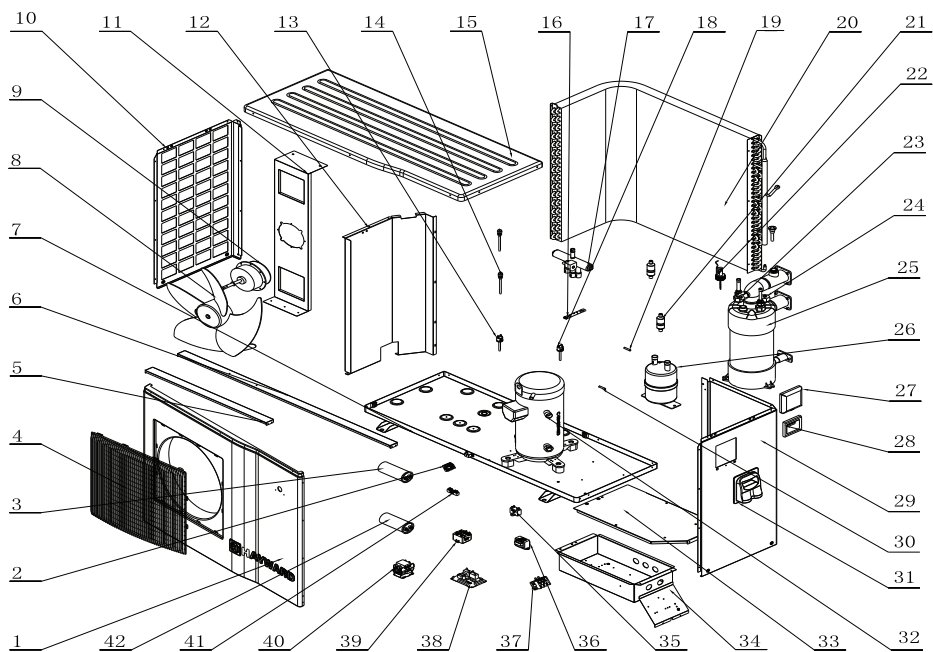

## 6. BIJLAGEN (vervolg)

### ECP 15

Rep	Ref.	Benaming	Rep	Ref.	Benaming
1	HWX32009210196	ABS-paneel Voor	23	HWX20003242	Temperatuursonde
2	HWX20003933	Aansluitblok 3 aansluitingen	24	HWX20003242	Temperatuursonde
3	HWX20003524	Condensator start CPS 98µF	25	HWX32091206	Titaancondensator/pvc
4	HWX35122213	Rooster	26	HWX35001401	Accumulator
5	HWX320921015	Verstijver Voor	27	HWX20002111	Controllerbeveiliging
6	HWX320921149	Verstijver Achter	28	HWX950531188	7 segmentencontroller
7	HWX32009210193	Frame	29	HWX32009210194	Rechterpaneel
8	HWX35002701	Ventilatorschroefblad	30	HWX20003242	Temperatuursonde
9	HWX34043301	Ventilatormotor	31	HWX32009220054	Greep
10	HWX32009210195	Linkerpaneel	32	HWX20011169	Compressor
11	HWX320921147	Motorsteun	33	HWX320921152	Elektrisch beveiligingspaneel
12	HWX320921148	Afscheidingspaneel	34	HWX320921151	Elektriciteitskast
13	HWX20013605	Drukregelaar hoge druk	35	HWX20003501	Condensator ventilator 3µF
14	HWX200014153	Shrader klep	36	HWX200037006	Transformator 230V~/12V~
15	HWX32009210197	ABS-paneel bovenaan	37	HWX20003920	Aansluitblok 3 aansluitingen
16	HWX20001489	Reductor	38	HWX950531145	Elektronische kaart PC1000
17	HWX20011491	4-wegklep	39	HWX20003676	Relais
18	HWX20003603	Drukregelaar lage druk	40	HWX200036007	Relais compressor
19	HWX20003242	Temperatuursonde	41	HWX20003909	Aansluitblok 2 aansluitingen
20	HWX351212001	Verdamper	42	HWX20003510	Condensator compressor 60µF
21	HWX20041444	Filter (Ø9.7-Ø9.7)	43	HWX20009909	Capillair
22	HWX200036005	Debietdetector			

## 6. BIJLAGEN (vervolg)

### 6.4 Herstelingsgids



**Bepaalde verrichtingen moeten door een erkend technicus uitgevoerd worden.**

Probleem	Foutcodes	Beschrijving	Oplossing
Defect sonde wateraanvoer	P01	De sensor is open of heeft een kortsluiting.	Controleer of vervang de sensor.
Defect sonde waterafvoer	P02	De sensor is open of heeft een kortsluiting.	Controleer of vervang de sensor.
Defect sonde buitentemperatuur	P04	De sensor is open of heeft een kortsluiting.	Controleer of vervang de sensor.
Defect ontdooiingssonde	P05	De sensor is open of heeft een kortsluiting.	Controleer of vervang de sensor.
Hogedrukbeveiliging	E01	Druk van het koelcircuit te hoog of waterdebiet te laag of verdamper verstopt of te laag luchtdebiet.	Controleer de drukregelaar van de hoge druk en de druk van het koelcircuit. Controleer het water- of luchtdebiet. Controleer of de debietregelaar goed werkt. Controleer de opening van de wateraanvoer/afvoerkleppen. Controleer de afstelling van de bypass.
Lagedrukbeveiliging	E02	Druk van het koelcircuit te laag of luchtdebiet te laag of verdamper verstopt.	Controleer de drukregelaar van de lage druk en de druk van het koelcircuit om te zien of er een lek is. Reinig het oppervlak van de verdamper. Controleer de rotatiesnelheid van de ventilator. Controleer de vrije luchtcirculatie door de verdamper.
Defect debietdetector	E03	Waterdebiet onvoldoende of detector in kortsluiting of defect	Controleer het waterdebiet, controleer de filterpomp en de debietdetector om te zien of er eventuele werkingsproblemen zijn.
Te groot temperatuurverschil tussen het aangevoerde en het afgevoerde water	E06	Waterdebiet in volume onvoldoende, verschil in waterdruk te laag / te hoog.	Controleer het waterdebiet of de verstopping van het systeem.
Antivriesbescherming Koude modus	E07	Te lage hoeveelheid waterafvoer.	Controleer het waterdebiet of de temperatuursensor van het afgevoerde water.
Communicatieprobleem	E08	Slechte werking van de LED-controller of de PCB-aansluiting.	Controleer de kabel aansluiting.
Antivriesbescherming van niveau 1	E19	Omgevingstemperatuur en temperatuur van het aangevoerde water te laag.	Stop de warmtepomp en leeg de condensor. Vorstgevaar.
Antivriesbescherming van niveau 2	E29	Omgevingstemperatuur en temperatuur van het aangevoerde water nog lager.	Stop de warmtepomp en leeg de condensor. Vorstgevaar.



## 6. BIJLAGEN (vervolg)

---

### 6.5 Garantie

#### GARANTIEVOORWAARDEN

Alle HAYWARD producten zijn gewaarborgd tegen productie- of materiaalfouten gedurende een periode van twee jaar vanaf de aankoopdatum. Elke garantie-aanvraag moet vergezeld zijn van een aankoopbewijs dat de datum ervan bewijst. We raden u dan ook aan uw factuur te bewaren.

De HAYWARD garantie is beperkt tot het herstellen of het vervangen, naar keuze van HAYWARD, van defecte producten voor zover ze aan een normaal gebruik onderworpen zijn volgens de voorschriften die in de gebruikershandleiding staan, het product geen enkele wijziging heeft ondergaan en enkel met HAYWARD-onderdelen en -bestanddelen gebruikt wordt. Beschadigingen door vorst en aantasting van chemische stoffen vallen niet onder de garantie.

Alle andere kosten (vervoer, arbeidskosten...) zijn van de garantie uitgesloten.

HAYWARD kan niet aansprakelijk gesteld worden voor rechtstreekse of onrechtstreekse schade die voortvloeit uit de installatie, de aansluiting of de onjuiste werking van een product.

Om de garantie aan te spreken en de reparatie of de vervanging van een artikel te vragen, wendt u zich tot uw dealer. Er zal geen enkele terugzending van materiaal naar onze fabriek aanvaard worden zonder ons voorafgaand schriftelijk akkoord.

Slijtageonderdelen zijn niet door de garantie gedekt.

# EASY TEMP

UNITÀ DI RISCALDAMENTO A POMPA DI CALORE PER PISCINE

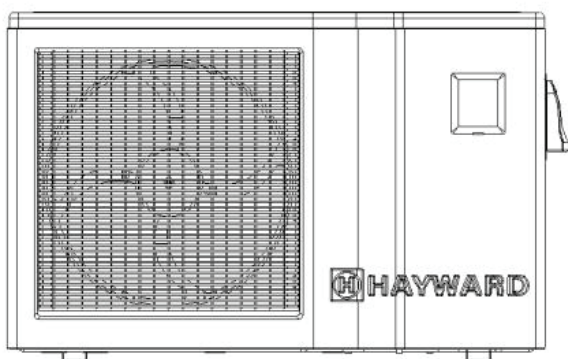

Manuale d'Uso e di Installazione

# SOMMARIO

---

## 1. Prefazione

---

<b>2. Caratteristiche tecniche</b>	<b>2</b>
2.1 Specifiche tecniche della pompa di calore	2
2.2 Range di funzionamento	3
2.3 Dimensioni	4

---

<b>3. Installazione e collegamento</b>	<b>5</b>
3.1 Schema di principio	5
3.2 Pompa di calore	5
3.3 Collegamento idraulico	6
3.4 Collegamento elettrico	7
3.5 Primo avviamento	8
3.6 Regolazione della portata d'acqua	10

---

<b>4. Interfaccia utente</b>	<b>11</b>
4.1 Presentazione generale	11
4.2 Regolazione dell'orologio	13
4.3 Regolazione della funzione Timer	13
4.4 Scelta della modalità di funzionamento: riscaldamento o raffreddamento	14
4.5 Regolazione e visualizzazione del set-point	15
4.6 Blocco e sblocco dell'interfaccia utente	15

---

<b>5. Manutenzione e svernamento</b>	<b>16</b>
5.1 Manutenzione	16
5.2 Svernamento	16

---

<b>6. Allegati</b>	<b>17</b>
6.1 Schemi elettrici	17
6.2 Collegamenti priorità riscaldamento	22
6.3 Viste esplose e ricambi	23
6.4 Guida alla risoluzione dei problemi	33
6.5 Garanzia	34

Leggere attentamente e conservare il manuale per eventuali future consultazioni.

Questo documento deve essere consegnato al proprietario della piscina che dovrà conservarlo in un luogo sicuro.

# 1. PREFERAZIONE

---

Vi ringraziamo per aver acquistato la pompa di calore per piscine Easy Temp. Questo prodotto è stato progettato secondo le più rigorose norme di fabbricazione per rispondere ai livelli di qualità richiesti. Questo manuale contiene tutte le informazioni necessarie per l'installazione, la ricerca guasti e la manutenzione ordinaria del prodotto. Leggere attentamente il manuale prima di aprire l'unità o eseguire degli interventi di manutenzione sul prodotto. Il fabbricante del prodotto declina ogni responsabilità per lesioni a persone e danni al prodotto riconducibili a errori di installazione, di ricerca guasti oppure a manutenzione inadeguata. È imperativo attenersi sempre alle istruzioni riportate nel presente manuale. L'unità deve essere installata da personale qualificato.

- Le riparazioni devono essere eseguite da personale qualificato.
- Tutti i collegamenti elettrici devono essere eseguiti da un elettricista professionale qualificato, in conformità con le norme vigenti nel paese di installazione vedere § 3.4.
- La manutenzione e i vari interventi devono essere eseguiti secondo le modalità e le tempistiche raccomandate, come specificato nel presente manuale.
- È vietato utilizzare ricambi non originali.
- L'inosservanza delle raccomandazioni indicate comporta l'annullamento della garanzia.
- Questa pompa di calore è intesa a riscaldare l'acqua della piscina e mantenerla a una temperatura costante; non può essere utilizzata per altri scopi.

Al termine della lettura, conservare il manuale per future consultazioni.

Avvertenza per bambini / persone con disabilità:

Questo apparecchio non è destinato ad essere utilizzato da persone (soprattutto bambini) con capacità fisiche, sensoriali o intellettuali limitate così come da persone che non hanno esperienza o conoscenza, salvo che i suddetti soggetti non siano sotto la supervisione di una terza persona o abbiamo ricevuto le necessarie istruzioni di utilizzo dell'apparecchio da una persona responsabile della loro sicurezza.

Questo prodotto contiene gas fluorurati ad effetto serra contemplati dal protocollo di Kyoto.

Tipo di refrigerante: R410A

Valore GWP<sup>(1)</sup>: 1975

È possibile che vengano richieste delle ispezioni periodiche di perdita di refrigerante in conformità con la normativa europea o locale. Per ulteriori informazioni, contattare il distributore locale.

---

(1) Potenziale di riscaldamento globale

## 2. CARATTERISTICHE TECNICHE

### 2.1 Specifiche tecniche della pompa di calore

Modello	EASY TEMP	ECP 06	ECP 08	ECP 11	ECP 13	ECP 15
Capacità termica *	kW BTU/h	5,5 18785	8 27322	11 37566	13.5 46105	15 51228
Potenza elettrica	kW	1,17	1,8	2,43	3	3,13
Corrente di funzionamento *	A	5,19	7,91	11,81	14,5	16
Alimentazione elettrica	V Ph/Hz	230 V ~ 1/50 Hz	230 V ~ 1/50 Hz	230 V ~ 1/50 Hz	230 V ~ 1/50 Hz	230 V ~ 1/50 Hz
Calibro fusibile tipo aM	A	8 aM	10 aM	16 aM	20 aM	20 aM
Disgiuntore curva D	A	8 D	10 D	16 D	20 D	20 D
Numero di compressori		1	1	1	1	1
Tipo di compressore		Rotativo	Rotativo	Rotativo	Scroll	Scroll
Numero di ventilatori		1	1	1	1	1
Potenza del ventilatore	W	50	120	120	120	120
Velocità di rotazione del ventilatore	GIRI/MIN.	770	850	850	850	850
Direzione del ventilatore		Orizzontale	Orizzontale	Orizzontale	Orizzontale	Orizzontale
Livello di pressione acustica (a 1 metro)	dB(A)	47	51	54	56	56
Collegamento idraulico	mm	50	50	50	50	50
Portata acqua	m³/h	2,3	3,0	4,5	5,3	6,6
Perdita di carico sull'acqua (max)	kPa	5,4	8,9	19,2	5,2	39,9
Dimensioni nette dell'unità (L/I/h)	mm	895/375/545	1035/415/650	1035/415/650	1136/440/870	1136/440/870
Dimensioni dell'unità imballata (L/I/h)	mm	970/430/710	1120/480/810	1180/480/810	1230/510/1020	1230/510/1020
Peso netto / peso dell'unità imballata	kg	45/56	54/68	60/74	95/115	117/128



\* Valore a +/- 5% in presenza delle seguenti condizioni: Temperatura esterna = 24°C (75°F) / HR=62% / Temperatura della piscina =27°C (80°F)

## 2. CARATTERISTICHE TECNICHE (seguito)

---

### 2.2 Range di funzionamento

Per un funzionamento sicuro ed efficiente, utilizzare la pompa di calore entro i limiti di temperatura e umidità indicati.

	Modalità riscaldamento 	Modalità raffreddamento 
Temperatura esterna	+2°C ~ +35°C	+7°C ~ +43°C
Temperatura dell'acqua	+12°C ~ +40°C	+8°C ~ +40°C
Umidità relativa	< 80%	< 80%
Range di regolazione set-point	+15°C ~ +40°C	+8°C ~ +35°C



***Se la temperatura o l'umidità non rientrano nei limiti indicati, è possibile che scattino i dispositivi di sicurezza inibendo il funzionamento della pompa.***

## 2. CARATTERISTICHE TECNICHE (seguito)

### 2.3 Dimensioni

Modelli: ECP06 / ECP08 / ECP11 / ECP13 / ECP15

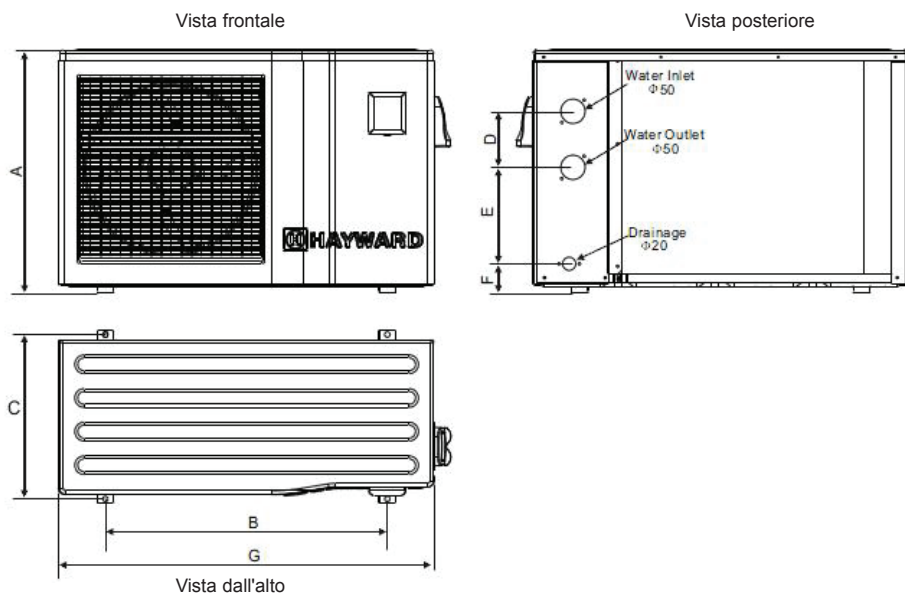

Unità: mm

Modello	ECP06	ECP08 ECP11	ECP13 ECP15
Numerazione			
<b>A</b>	540	648	866
<b>B</b>	571	755	840
<b>C</b>	400	440	470
<b>D</b>	140	150	150
<b>E</b>	258	258	330
<b>F</b>	66	77	80
<b>G</b>	860	1004	1114

## 3. INSTALLAZIONE E COLLEGAMENTO

### 3.1 Schema di principio

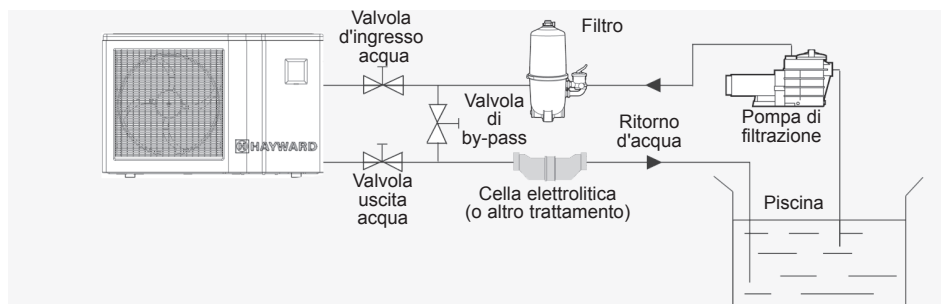

Nota: La pompa di calore viene fornita priva di dispositivo di trattamento o di filtrazione. I componenti indicati sullo schema sono forniti dall'installatore.

### 3.2 Pompa di calore



**Installare la pompa di calore all'esterno e all'esterno di locali tecnici chiusi.**

**Installata in una posizione riparata, rispettare le distanze minime sotto indicate per evitare rischi di ricircolazione di aria e un degrado delle prestazioni globali della pompa di calore.**

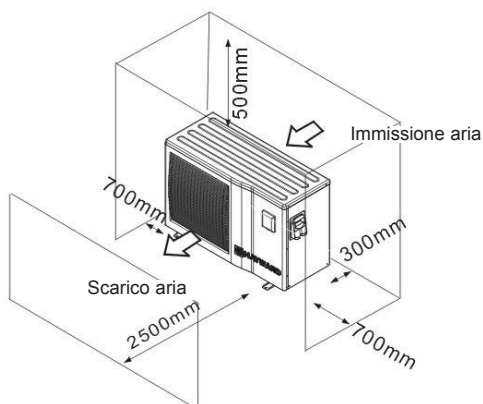



### 3. INSTALLAZIONE E COLLEGAMENTO (seguito)

---



*Si consiglia di installare la pompa di calore preferibilmente su una lastra in cemento separata o su un apposito basamento a seggiola e di posizionarla sui silent block forniti (viti e rondelle non fornite).*

*La distanza massima d'installazione tra la pompa di calore e la piscina è di 15 metri.*

*Lunghezza totale andata-ritorno delle canalizzazioni idrauliche 30 metri.*

*Isolare le canalizzazioni idrauliche di superficie e interrate.*

#### 3.3 Collegamento idraulico

La pompa di calore viene fornita con due raccordi di 50 mm di diametro. Per la canalizzazione idraulica utilizzare tubi in PVC Ø 50 mm. Collegare l'ingresso d'acqua della pompa di calore al condotto proveniente dal filtro di filtrazione, quindi collegare l'uscita d'acqua della pompa di calore al condotto d'acqua diretto verso la vasca (vedere lo schema sottostante).

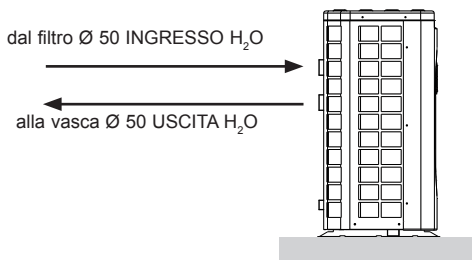

Installare una valvola di "bypass" tra l'ingresso e l'uscita della pompa di calore.



*Se si utilizza un distributore automatico o una cella elettrolitica, tali dispositivi dovranno essere obbligatoriamente installati dopo la pompa di calore in modo da proteggere il condensatore in titanio da una concentrazione troppo elevata di prodotto chimico.*



*Installare correttamente la valvola di bypass e i raccordi a livello di ingresso e di uscita acqua dell'unità in modo da semplificare lo scarico nel periodo invernale e agevolare l'accesso e lo smontaggio dell'unità per la manutenzione.*

### 3. INSTALLAZIONE E COLLEGAMENTO (seguito)

#### 3.4 Collegamento elettrico



**L'installazione elettrica e il cablaggio di questo dispositivo devono essere conformi alle norme di installazioni locali in vigore.**

F	NF C15-100	GB	BS7671:1992
D	DIN VDE 0100-702	EW	EVHS-HD 384-7-702
A	ÖVE 8001-4-702	H	MSZ 2364-702/1994/MSZ 10-553 1/1990
E	UNE 20460-7-702 1993, RECBT ITC-BT-31 2002	M	MSA HD 384-7-702.S2
IRL	Wiring Rules + IS HD 384-7-702	PL	PN-IEC 60364-7-702:1999
I	CEI 64-8/7	CZ	CSN 33 2000 7-702
LUX	384-7.702 S2	SK	STN 33 2000-7-702
NL	NEN 1010-7-702	SLO	SIST HD 384-7-702.S2
P	RSIUEE	TR	TS IEC 60364-7-702



**Assicurarsi che l'alimentazione elettrica disponibile e la frequenza della rete elettrica corrispondano ai requisiti, tenendo in considerazione la posizione di montaggio specifica dell'apparecchio e la corrente necessaria per alimentare gli altri dispositivi collegati allo stesso circuito.**

**ECP 06 230 V~ +/- 10 % 50 HZ Monofase**

**ECP 08 230 V~ +/- 10 % 50 HZ Monofase**

**ECP 11 230 V~ +/- 10 % 50 HZ Monofase**

**ECP 13 230 V~ +/- 10 % 50 HZ Monofase**

**ECP 15 230 V~ +/- 10 % 50 HZ Monofase**

**Attenersi al corrispondente schema di cablaggio allegato.**

**La scatola di collegamento si trova sul lato destro dell'unità. Tre collegamenti sono desinati all'alimentazione elettrica, due al comando della pompa di filtrazione (Asservimento).**

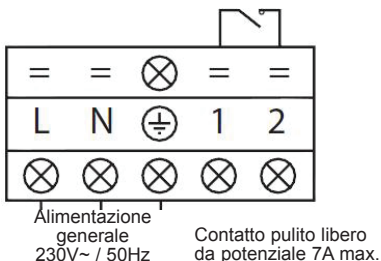

### 3. INSTALLAZIONE E COLLEGAMENTO (seguito)

---



**La rete di alimentazione elettrica deve essere dotata, in modo appropriato, di un dispositivo di protezione fusibile di tipo alimentazione motore (aM) o di un disgiuntore curva D nonché di un disgiuntore differenziale 30 mA (vedere la tabella).**

Modelli		ECP 06	ECP 08	ECP 11	ECP 13	ECP 15
Alimentazione elettrica	V/Ph/ Hz	230 V~ 1/50 Hz	230 V~ 1/50 Hz	230 V~ 1/50 Hz	230 V~ 1/50 Hz	230 V~ 1/50 Hz
Calibro fusibile tipo aM	A	8 aM	10 aM	16 aM	20 aM	20 aM
Disgiuntore curva D	A	8 D	10 D	16 D	20 D	20 D



**Escludere sempre l'alimentazione principale prima di aprire il quadro di comando elettrico.**

#### 3.5 Primo avviamento

Procedura di avviamento - dopo aver completato l'installazione, eseguire le seguenti operazioni:

- 1) Ruotare manualmente il ventilatore e controllare se gira liberamente e se l'elica è correttamente fissata all'albero del motore.
- 2) Controllare che l'unità sia collegata correttamente all'alimentazione principale (vedere lo schema di cablaggio allegato).
- 3) Attivare la pompa di filtrazione.
- 4) Verificare che tutte le valvole d'acqua siano aperte e che l'acqua scorra verso l'unità, prima di passare in modalità di riscaldamento o di raffreddamento.
- 5) Verificare che il tubo di scarico condensa sia fissato correttamente e che non sia intasato.
- 6) Attivare l'alimentazione elettrica destinata all'unità, quindi premere il pulsante ON/OFF  sul pannello di controllo.

### 3. INSTALLAZIONE E COLLEGAMENTO (seguito)

---

- 7) Quando l'unità è su ON, assicurarsi che non compaia nessun codice di ALLARME (vedere Guida alla risoluzione dei problemi).
- 8) Definire la portata d'acqua con l'ausilio della valvola di bypass (vedere § 3.6 et 2.1), così come prevista rispettivamente per ogni modello, in modo da ottenere una differenza di temperatura Ingresso/Uscita di 2°C.
- 9) Dopo qualche minuto di funzionamento, controllare che l'aria in uscita dall'unità si sia raffreddata (tra 5 e 10°).
- 10) Con l'unità in servizio, disattivare la pompa di filtrazione. L'unità dovrà arrestarsi automaticamente e visualizzare il codice d'errore E03.
- 11) Lasciare in funzione l'unità e la pompa della piscina 24 ore su 24, fino a raggiungere la temperatura desiderata per l'acqua. Quando la temperatura in ingresso dell'acqua raggiunge il valore di set-point, l'unità si ferma. L'unità si riavvierà automaticamente (finché la pompa della piscina è in funzione) se la temperatura della piscina è inferiore di almeno 0,5°C rispetto alla temperatura di set-point.

**Controller di portata** - L'unità è dotata di un controller di portata che attiva la pompa di calore quando la pompa di filtrazione della piscina è in funzione e la disattiva quando la pompa di filtrazione non è invece in funzione. In assenza d'acqua, viene visualizzato il codice d'allarme E03 sul regolatore (Vedere § 6.4).

**Timer** - l'unità integra un timer di 3 minuti per proteggere i componenti del circuito di controllo, eliminare ogni instabilità a livello di riavvio e ogni interferenza a livello del contattore. Grazie a questo timer, l'unità si riavvia automaticamente ogni 3 minuti circa dopo un'interruzione del circuito di controllo. Anche una breve interruzione di corrente attiva il timer di riavvio.

### 3. INSTALLAZIONE E COLLEGAMENTO (seguito)

#### 3.6 Regolazione della portata d'acqua

Quando la pompa di calore è in funzione e le valvole d'ingresso e di uscita d'acqua sono aperte, regolare la valvola detta di "bypass" in modo da ottenere una differenza di 2°C tra la temperatura d'ingresso e di uscita dell'acqua (vedere schema di principio § 3.1). Per controllare lo stato della regolazione, è sufficiente visualizzare le temperature ingresso (T02) / uscita (T03) direttamente sul pannello di controllo attenendosi alla procedura di seguito descritta.

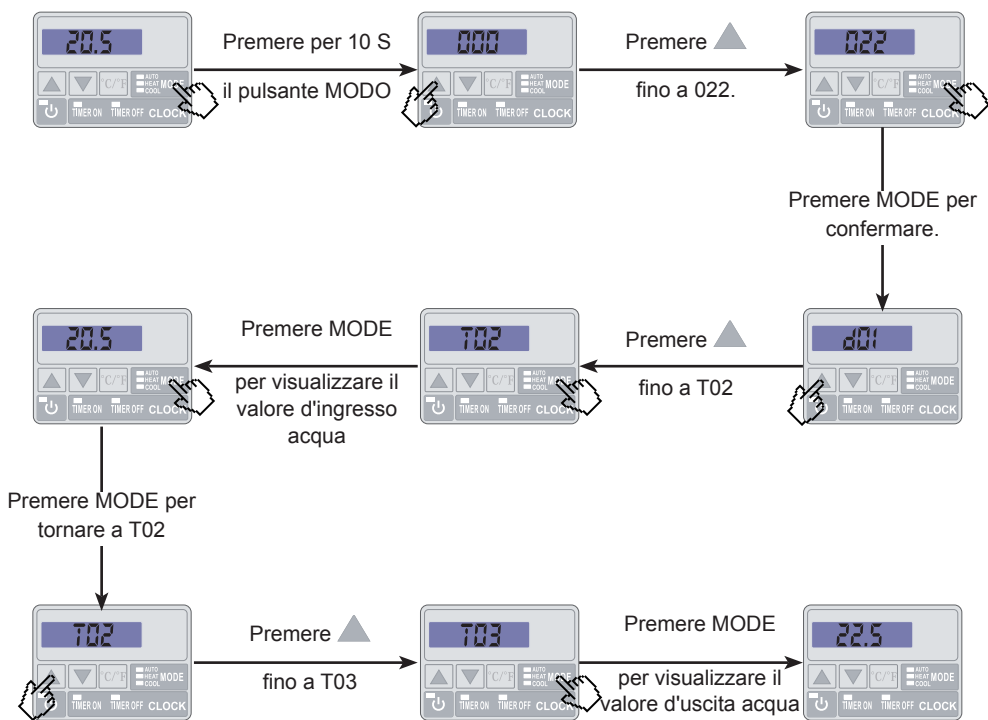

Regolare quindi la valvola di bypass in modo da ottenere una differenza di 2°C tra T03 e T02 ( $T03 - T02 = \Delta T = 2$ ).

Premere 2 volte  per uscire dal menu.

Nota: L'apertura della valvola detta di "bypass" genera una portata meno rilevante con conseguente aumento del  $\Delta T$ .

La chiusura della valvola detta di "bypass" genera una portata più rilevante con conseguente diminuzione del  $\Delta T$ .

## 4. INTERFACCIA UTENTE



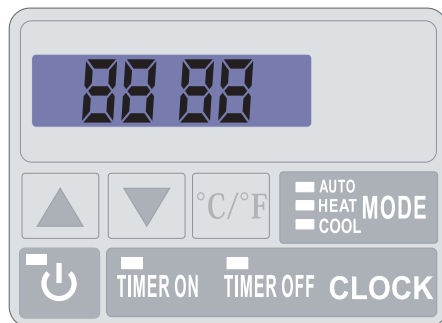

---

### 4.1 Presentazione generale

La pompa di calore è dotata di un pannello di controllo elettronico, collegato elettricamente e pre-regolato in fabbrica in modalità riscaldamento.



#### Legenda

-  **COOL** Simbolo Modalità raffreddamento
-  **HEAT** Simbolo Modalità riscaldamento
-  **AUTO** Modalità automatica
-  **CLOCK** Regolazione ora e timer
-  **MODE** Pulsante di selezione e regolazione
-  Pulsante On/Off e indietro/convalida
-  Scorrimento in basso
-  Scorrimento in alto
-  **TIMER ON** Regolazione ora di avvio
-  **TIMER OFF** Regolazione ora di spegnimento

## 4. INTERFACCIA UTENTE (seguito)

---

### Modo OFF

Quando la pompa di calore è in standby (Modo OFF), lo schermo del regolatore visualizza l'ora e la modalità di funzionamento.

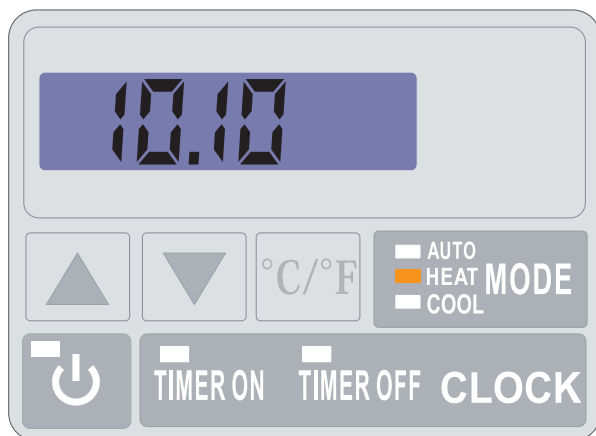

### Modo ON



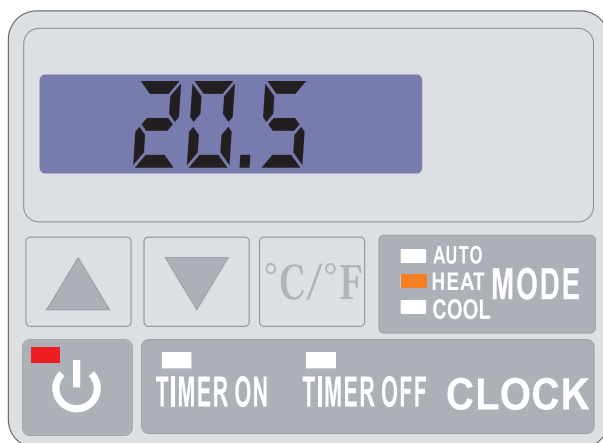

Quando la pompa di calore è in funzione o in regolazione (Modo ON), l'indicatore del pulsante ON si illumina in rosso e sullo schermo viene visualizzata la temperatura d'ingresso dell'acqua.



## 4. INTERFACCIA UTENTE (seguito)

---

### 4.2 Regolazione dell'orologio





Si può regolare l'orologio nel modo sia ON sia OFF. Premendo "CLOCK", il display lampeggia; premendo di nuovo "CLOCK", lampeggiano le ore. Regolare le ore utilizzando le frecce  o  quindi premere di nuovo "CLOCK" per selezionare i minuti. Regolare i minuti utilizzando le frecce  o . Premere "CLOCK" per confermare. Il display ritorna allo stato precedente.

Nota: Premere il pulsante "CLOCK" per salvare i dati di regolazione; i dati verranno comunque salvati automaticamente se non viene premuto nessun pulsante per 5 secondi.

### 4.3 Regolazione della funzione Timer

Eseguire questa regolazione quando l'utente desidera far funzionare la pompa di calore per un periodo più breve di quello definito dall'orologio di filtrazione. In tal caso, si può programmare un avvio differito e un arresto anticipato oppure semplicemente escludere una fascia oraria di funzionamento (ad esempio di notte).





#### Programmazione Avvio (Timer ON) / ON

- 1) Premendo "Timer ON", l'ora lampeggia.
- 2) Premere "Timer ON" per regolare l'ora con i pulsanti  .
- 3) Premere "Timer ON" per regolare i minuti con i pulsanti  .

Per salvare i dati di regolazione, premere il pulsante «Timer ON»; i dati verranno comunque salvati automaticamente se non viene premuto nessun pulsante per 5 secondi.

Un indicatore verde indica che il timer è attivato.

#### Programmazione spegnimento (Timer OFF) / OFF

- 1) Premendo "Timer OFF", l'ora lampeggia.
- 2) Premere "Timer OFF" per regolare l'ora con i pulsanti  .
- 3) Premere "Timer OFF" per regolare i minuti con i pulsanti  .

Per salvare i dati di regolazione, premere il pulsante "Timer OFF"; i dati verranno comunque salvati automaticamente se non viene premuto nessun pulsante per 5 secondi.



Un indicatore rosso indica che il timer è attivato.



## 4. INTERFACCIA UTENTE (seguito)

---

### Annullamento dei Timer (Timer ON e OFF) / ON/OFF

- 1) Premendo "Timer O", lampeggia "Timer ON".
- 2) Premere  per annullare la programmazione.
- 3) Premendo "Timer OFF", lampeggia "Timer OFF".
- 4) Premere  per annullare la programmazione.

### 4.4 Scelta della modalità di funzionamento: riscaldamento, raffreddamento o automatico.

#### Nel Modo "OFF" o "ON"

Premere il pulsante "MODE" per commutare dalla modalità raffreddamento (indicatore verde) alla modalità riscaldamento (indicatore arancione) alla modalità automatica (indicatore rosso).

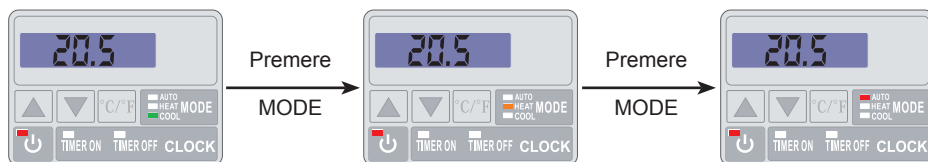



## 4. INTERFACCIA UTENTE (seguito)

---



### 4.5 Regolazione e visualizzazione del set-point (temperatura desiderata dell'acqua)

Nel Modo "OFF" e nel Modo "ON"

Premere i pulsanti  o  per definire il set-point desiderato. La regolazione viene eseguita con una precisione di 0,5°C.



*Si consiglia di non superare mai la temperatura di 30°C per evitare l'alterazione dei liner.*

Nota: Con unità accesa o spenta, basta premere il pulsante  o  per visualizzare o modificare il set-point.

### 4.6 Blocco e sblocco del touch screen

Premere il pulsante On/Off  per 5 secondi fino a che non viene generato un beep. I pulsanti diventano inattivi.

Per sbloccare, premere  per 5 secondi fino a che non viene generato un beep.

I pulsanti ridiventano attivi.

## 5. MANUTENZIONE E SVERNAMENTO

---

### 5.1 Manutenzione

Per garantire la durata e il corretto funzionamento della pompa di calore, si devono eseguire le operazioni di manutenzione ordinaria qui descritte una volta all'anno.

- Pulire l'evaporatore con una spazzola soffice oppure con un getto d'aria o acqua (**Non utilizzare mai dispositivi di pulizia ad alta pressione**).
- Controllare che la condensa venga scaricata correttamente.
- Controllare il serraggio dei raccordi idraulici ed elettrici.



***Prima di ogni intervento, scollegare la pompa di calore dall'alimentazione elettrica. Le operazioni di manutenzione devono essere eseguite solo da personale qualificato e autorizzato a manipolare i refrigeranti.***

- Controllare la tenuta idraulica del condensatore.

### 5.2 Svernamento

- Commutare la pompa di calore in Modo "OFF".
- Escludere l'alimentazione dalla pompa di calore.
- Svuotare il condensatore utilizzando lo scarico per evitare rischi di degrado. (Rischio importante di gelo).
- Chiudere la valvola di bypass e svitare i raccordi ingresso/uscita.
- Eliminare quanto più possibile l'acqua stagnante residua dal condensatore con l'ausilio di una pistola ad aria.
- Tappare ingresso e uscita della pompa di calore per evitare l'intrusione di corpi estranei.
- Ricoprire la pompa di calore con un telone invernale (non fornito).



***Qualsiasi danno causato da una protezione invernale inadeguata comporterà l'annullamento della garanzia.***

# 6. ALLEGATI

## 6.1 Schemi elettrici

ECP 06

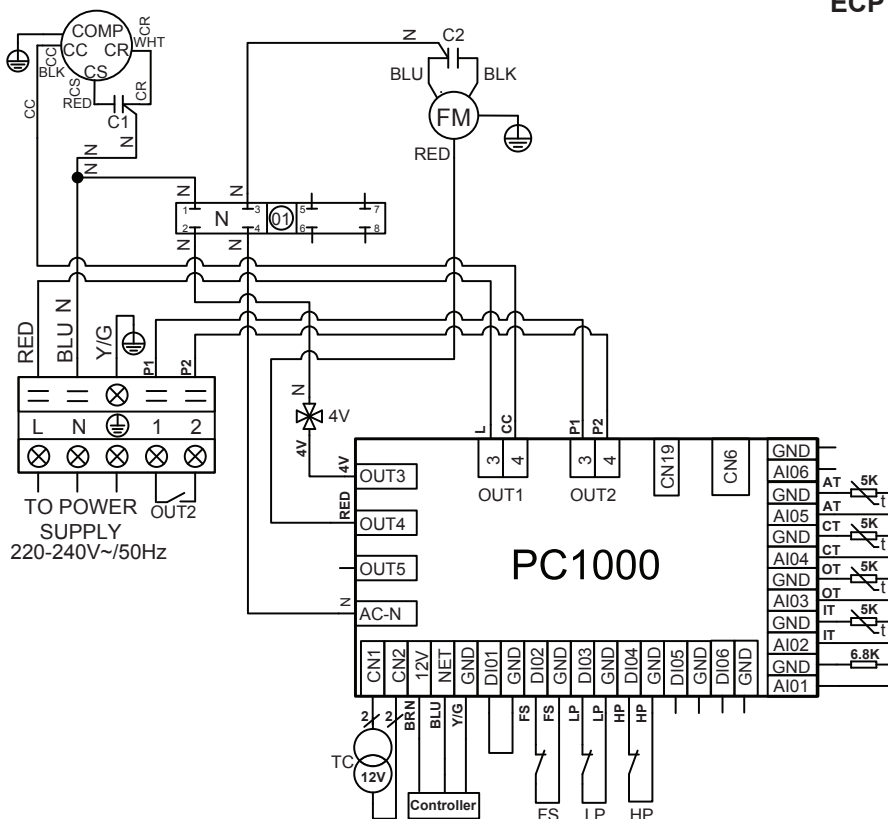

**NOTE:**

AT: SONDA DI TEMPERATURA ARIA  
 COMP: COMPRESSORE  
 CT: SONDA TEMPERATURA EVAPORATORE  
 FM: MOTORE VENTILATORE  
 FS: RIVELATORE PRESENZA ACQUA  
 HP: PRESSOSTATO ALTA PRESSIONE  
 IT: SONDA TEMPERATURA INGRESSO ACQUA

LP: PRESSOSTATO BASSA PRESSIONE  
 OT: SONDA TEMPERATURA USCITA ACQUA  
 TC: TRASFORMATORE 230V~/ 12V~  
 4V: VALVOLA A 4 VIE  
 C1: CONDENSATORE COMPRESSORE  
 C2: CONDENSATORE VENTILATORE  
 OUT2 : CONTATTO PULITO LIBERO DA POTENZIALE  
 7A MAX.

## 6. ALLEGATI (seguito)

ECP 08

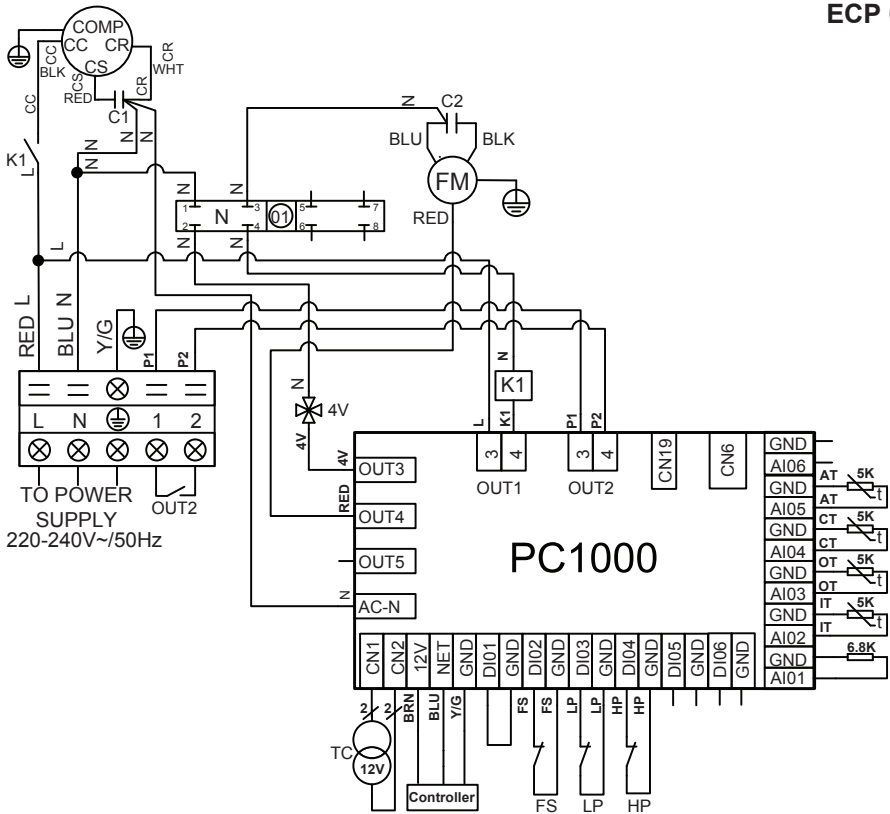

**NOTE:**

- AT: SONDA DI TEMPERATURA ARIA
- COMP: COMPRESSORE
- CT: SONDA TEMPERATURA EVAPORATORE
- FM: MOTORE VENTILATORE
- FS: RIVELATORE PRESENZA ACQUA
- HP: PRESSOSTATO ALTA PRESSIONE
- IT: SONDA TEMPERATURA INGRESSO ACQUA

- LP: PRESSOSTATO BASSA PRESSIONE
- OT: SONDA TEMPERATURA USCITA ACQUA
- TC: TRASFORMATORE 230V~/ 12V~
- 4V: VALVOLA A 4 VIE
- K1: RELÈ COMPRESSORE
- C1: CONDENSATORE COMPRESSORE
- C2: CONDENSATORE VENTILATORE
- OUT2 : CONTATTO PULITO LIBERO DA POTENZIALE 7A MAX.

# 6. ALLEGATI (seguito)

ECP 11

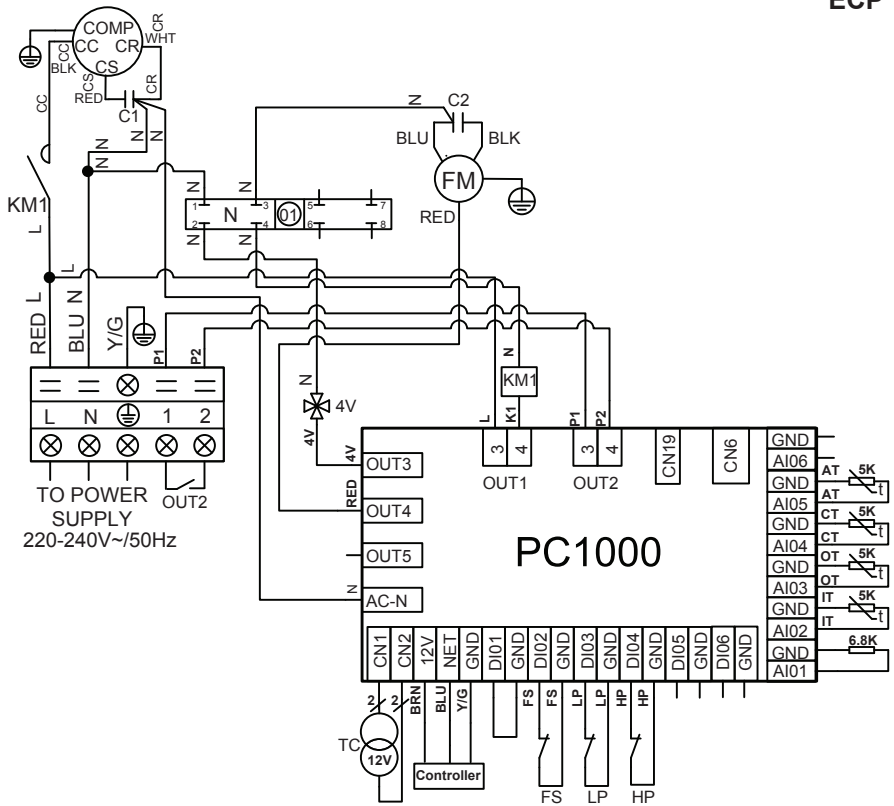

**NOTE:**

- AT: SONDA DI TEMPERATURA ARIA
- COMP: COMPRESSORE
- CT: SONDA TEMPERATURA EVAPORATORE
- FM: MOTORE VENTILATORE
- FS: RIVELATORE PRESENZA ACQUA
- HP: PRESSOSTATO ALTA PRESSIONE
- IT: SONDA TEMPERATURA INGRESSO ACQUA

- LP: PRESSOSTATO BASSA PRESSIONE
- OT: SONDA TEMPERATURA USCITA ACQUA
- TC: TRASFORMATORE 230V~/ 12V~
- 4V: VALVOLA A 4 VIE
- KM1: CONTATTORE DI POTENZA COMPRESSORE
- C1: CONDENSATORE COMPRESSORE
- C2: CONDENSATORE VENTILATORE
- OUT2 : CONTATTO PULITO LIBERO DA POTENZIALE 7A MAX.

## 6. ALLEGATI (seguito)

ECP 13

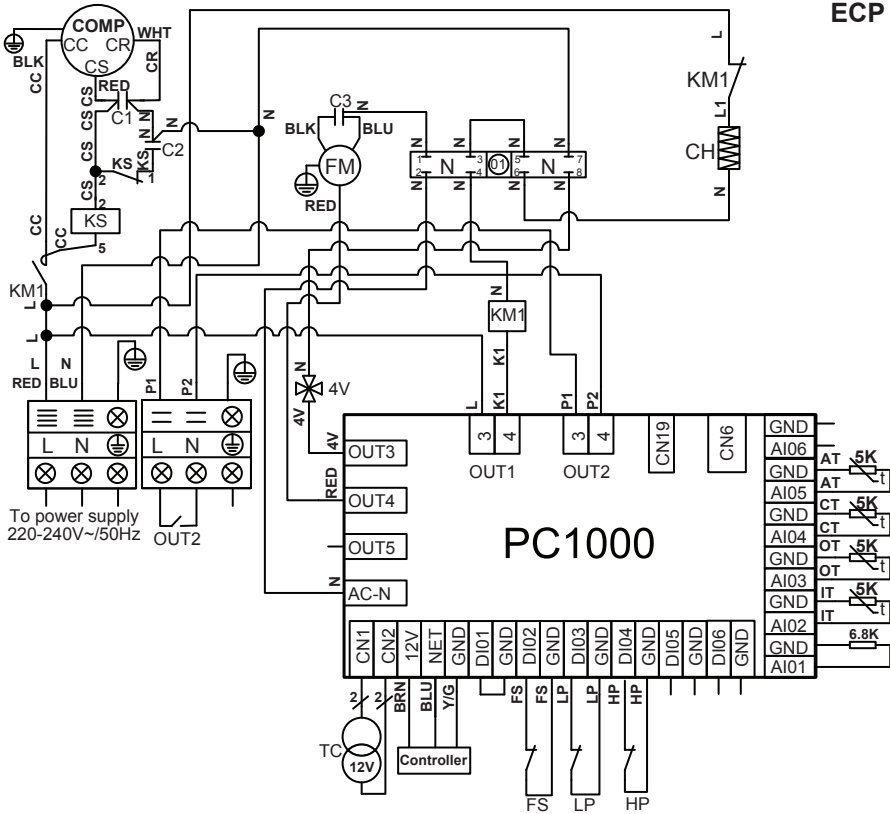

**NOTE:**

AT: SONDA DI TEMPERATURA ARIA  
 COMP: COMPRESSORE  
 CH: RESISTENZA CARTER  
 CT: SONDA TEMPERATURA EVAPORATORE  
 FM: MOTORE VENTILATORE  
 FS: RIVELATORE PRESENZA ACQUA  
 HP: PRESSOSTATO ALTA PRESSIONE  
 IT: SONDA TEMPERATURA INGRESSO ACQUA

KS: BOBINA DEL RELÈ DI AVVIAMENTO DEL COMPRESSORE  
 LP: PRESSOSTATO BASSA PRESSIONE  
 OT: SONDA TEMPERATURA USCITA ACQUA  
 TC: TRASFORMATORE 230V~ / 12V~  
 4V: VALVOLA 4 VIE  
 KM1: CONTATTORE DI POTENZA COMPRESSORE  
 C1: CONDENSATORE PERMANENTE  
 C2: CONDENSATORE DI AVVIAMENTO  
 OUT2 : CONTATTO PULITO LIBERO DA POTENZIALE 7A MAX.

# 6. ALLEGATI (seguito)

ECP 15

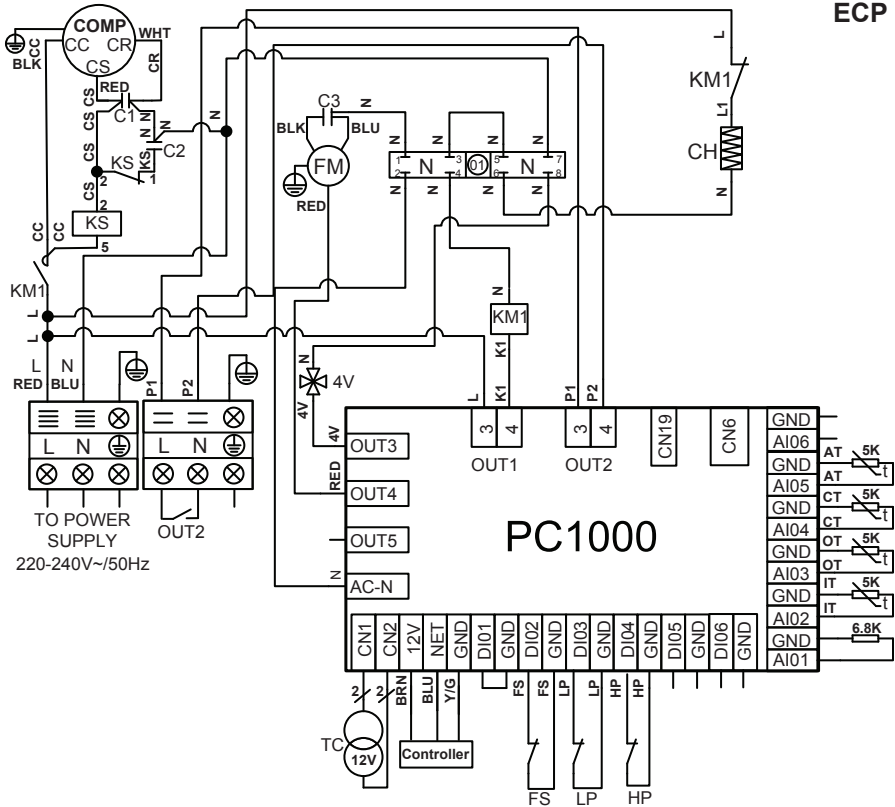

**NOTE:**

- AT: SONDA DI TEMPERATURA ARIA
- COMP: COMPRESSORE
- CH: RESISTENZA CARTER
- CT: SONDA TEMPERATURA EVAPORATORE
- FM: MOTORE VENTILATORE
- FS: RIVELATORE PRESENZA ACQUA
- HP: PRESSOSTATO ALTA PRESSIONE
- IT: SONDA TEMPERATURA INGRESSO ACQUA

- KS: BOBINA DEL RELÈ DI AVVIAMENTO DEL COMPRESSORE
- LP: PRESSOSTATO BASSA PRESSIONE
- OT: SONDA TEMPERATURA USCITA ACQUA
- TC: TRASFORMATORE 230V~ / 12V~
- 4V: VALVOLA A 4 VIE
- KM1: CONTATTORE DI POTENZA COMPRESSORE
- C1: CONDENSATORE PERMANENTE
- C2: CONDENSATORE DI AVVIAMENTO
- OUT2 : CONTATTO PULITO LIBERO DA POTENZIALE 7A MAX.



## 6. ALLEGATI (seguito)

### 6.2 Collegamenti priorità riscaldamento Pompa monofase

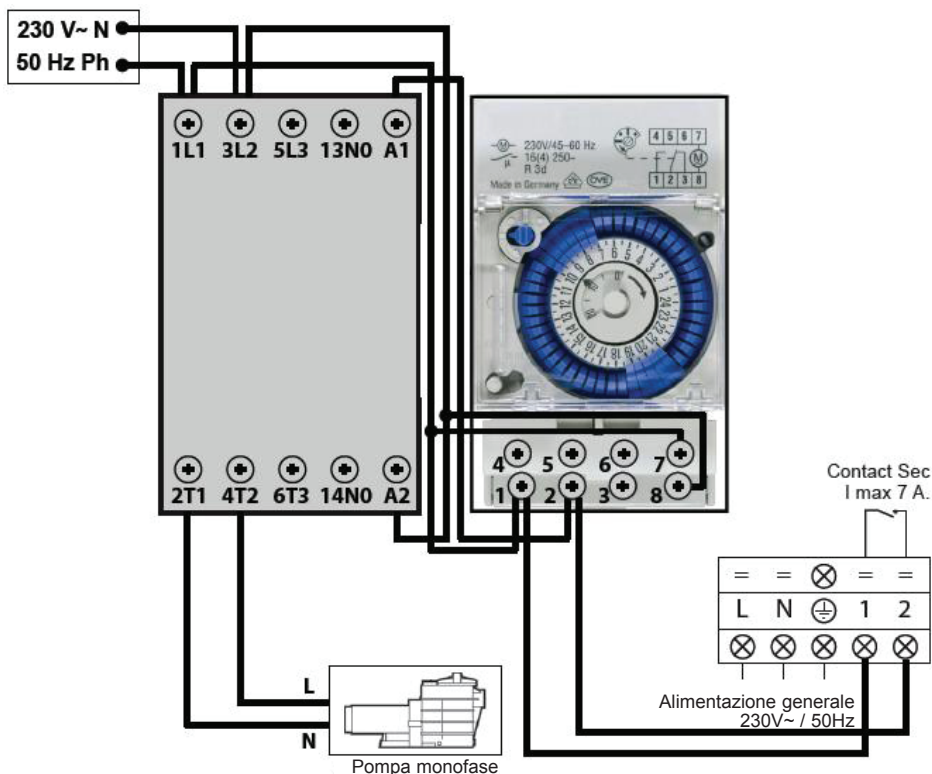

I morsetti 1 e 2 offrono un contatto pulito libero da potenziale, senza polarità 230 V~ / 50 Hz.

Collegare i morsetti 1 e 2 come indicato nello schema di cablaggio di cui sopra per garantire il funzionamento della pompa di filtraggio per un ciclo di 2 min. ogni ora qualora la temperatura all'interno della vasca fosse inferiore al set point impostato.

 Non collegare l'alimentazione della pompa di filtraggio direttamente ai morsetti 1 e 2.



## 6. ALLEGATI (seguito)

---

### 6.3 Viste esplose e ricambi

ECP 06

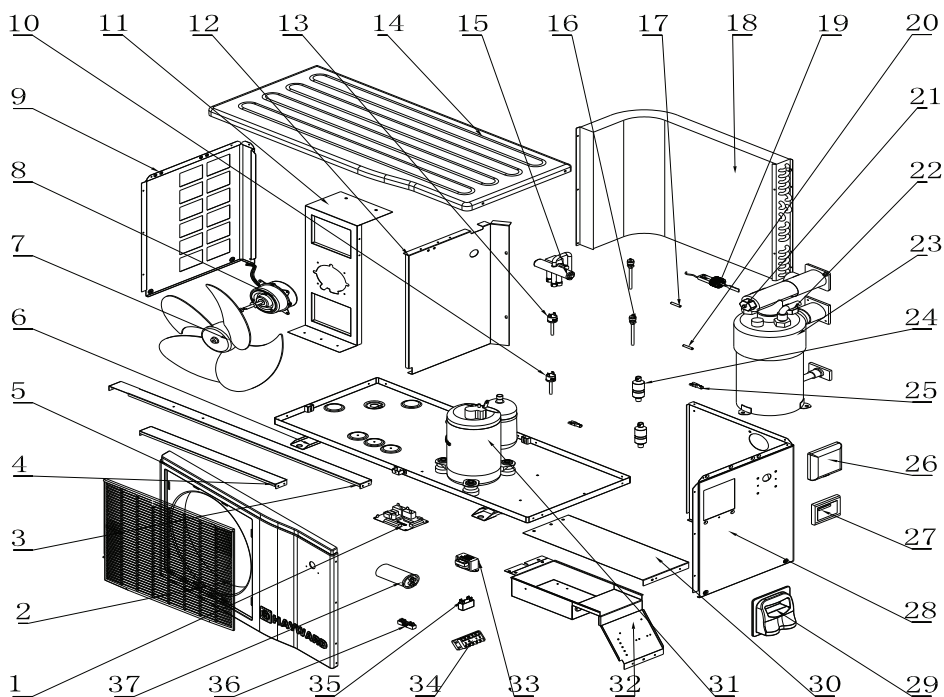

## 6. ALLEGATI (seguito)

---

### ECP 06

Num	Rif.	Descrizione	Num	Rif.	Descrizione
1	HWX950531145	Scheda elettronica PC1000	20	HWX20003242	Sonda di temperatura
2	HWX35252208	Griglia	21	HWX20003242	Sonda di temperatura
3	HWX322521062	Rinforzo posteriore	22	HWX20003242	Sonda di temperatura
4	HWX322521063	Rinforzo anteriore	23	HWX35251210	Condensatore Titanio/ PVC
5	HWX32025210084	Pannello in ABS anteriore	24	HWX20041444	Filtro (Ø9,7 - Ø9,7)
6	HWX32025210081	Telaio	25	HWX200014068	Connettore capillare
7	HWX34012701	Pala ventilatore	26	HWX20002111	Protezione controller
8	HWX34013301	Motore Ventilatore	27	HWX950531188	Controller a 7 segmenti
9	HWX32025210083	Pannello sinistro	28	HWX32025210082	Pannello destro
10	HWX20003603	Pressostato Bassa pressione	29	HWX32009220054	Maniglia
11	HWX322521061	supporto motore	30	HWX322521064	Pannello di protezione elettrica
12	HWX322521059	Pannello di separazione	31	HWX200011006	Compressore
13	HWX20013605	Pressostato Alta pressione	32	HWX322521006	Quadro elettrico
14	HWX32025210085	Pannello ABS superiore	33	HWX200037006	Trasformatore 230V~/12V~
15	HWX20011418	Valvola a 4 vie	34	HWX40003901	Morsettiera elettrica 5 connessioni
16	HWX200014153	Valvola Shrader	35	HWX20003506	Condensatore ventilatore 2µF
17	HWX20003242	Sonda di temperatura	36	HWX20003909	Morsettiera 2 connessioni
18	HWX40001230	Evaporatore	37	HWX20003504	Condensatore compressore 35µF
19	HWX200036005	Rivelatore di portata	38	HWX20009910	Capillare

## 6. ALLEGATI (seguito)

---

### ECP 08

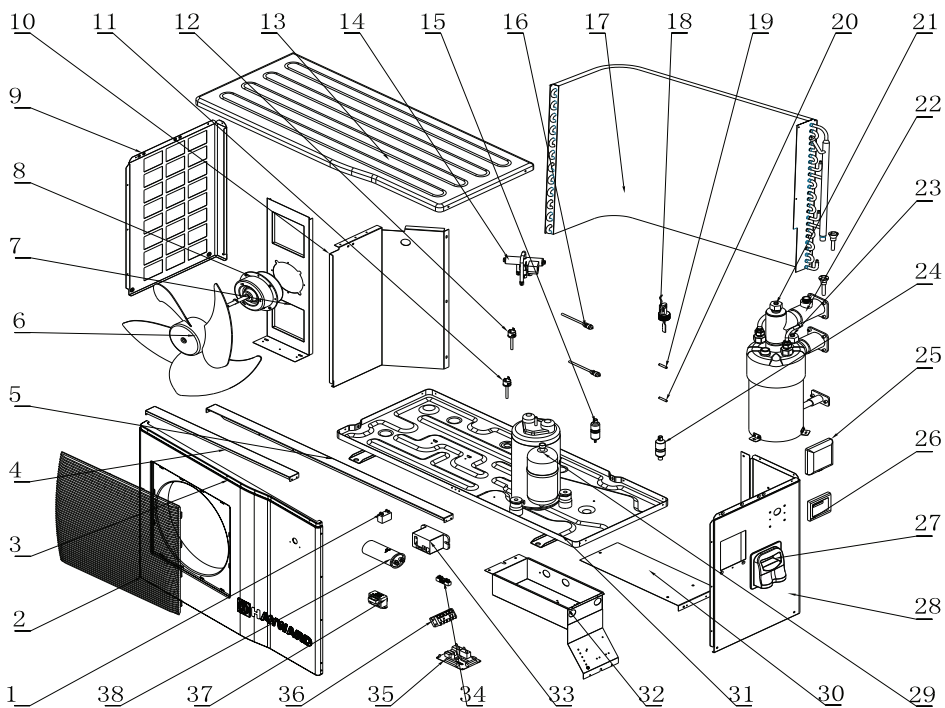

## 6. ALLEGATI (seguito)

### ECP 08

Num	Rif.	Descrizione	Num	Rif.	Descrizione
1	HWX20003501	Condensatore ventilatore 3µF	21	HWX20003242	Sonda di temperatura
2	HWX35122213	Griglia	22	HWX32081205	Condensatore Titanio/PVC
3	HWX32012210240	Pannello in ABS anteriore	23	HWX20003242	Sonda di temperatura
4	HWX321221175	Rinforzo anteriore	24	HWX20041445	Filter(Φ9.7-Φ4.2)
5	HWX321221018	Rinforzo posteriore	25	HWX20002111	Protezione controller
6	HWX35002701	Pala ventilatore	26	HWX950531188	Controller a 7 segmenti
7	HWX321221174	supporto motore	27	HWX32009220054	Maniglia
8	HWX34043301	Motore Ventilatore	28	HWX32012210238	Pannello destro
9	HWX32012210238	Pannello sinistro	29	HWX200011135	Compressore
10	HWX321221173	Pannello di separazione	30	HWX321221019	Pannello di protezione elettrica
11	HWX20013605	Pressostato Alta pressione	31	HWX32012210237	Telaio
12	HWX20003603	Pressostato Bassa pressione	32	HWX321221176	Quadro elettrico
13	HWX321222039	Pannello ABS superiore	33	HWX20003619	Relè
14	HWX20011418	Valvola a 4 vie	34	HWX20003909	Morsettiera 2 connessioni
15	HWX20041446	Filtro (Ø9,7 - Ø3,4)	35	HWX950531145	Scheda elettronica PC1000
16	HWX200014153	Valvola Shrader	36	HWX40003901	Morsettiera elettrica 5 connessioni
17	HWX34061204	Evaporatore	37	HWX200037006	Trasformatore 230V~/12V~
18	HWX200036005	Rivelatore di portata	38	HWX20003510	Condensatore compressore 60µF
19	HWX20003242	Sonda di temperatura	39	HWX20009909	Capillare
20	HWX20003242	Sonda di temperatura			

## 6. ALLEGATI (seguito)

---

### ECP 11

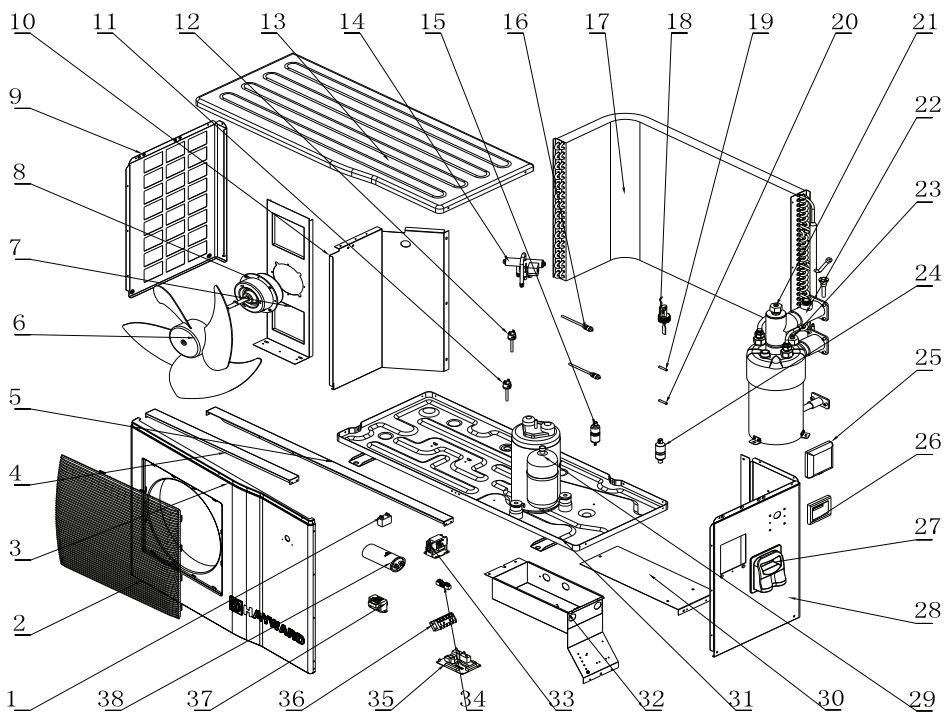

## 6. ALLEGATI (seguito)

### ECP 11

Num	Rif.	Descrizione	Num	Rif.	Descrizione
1	HWX20003501	Condensatore ventilatore 3 $\mu$ F	21	HWX20003242	Sonda di temperatura
2	HWX35122213	Griglia	22	HWX32121209	Condensatore Titanio/PVC
3	HWX32012210240	Pannello in ABS anteriore	23	HWX20003242	Sonda di temperatura
4	HWX3212221175	Rinforzo anteriore	24	HWX20041445	Filter( $\Phi$ 9.7- $\Phi$ 4.2)
5	HWX3212221018	Rinforzo posteriore	25	HWX20002111	Protezione controller
6	HWX35002701	Pala ventilatore	26	HWX950531188	Controller a 7 segmenti
7	HWX3212221174	supporto motore	27	HWX32009220054	Maniglia
8	HWX34043301	Motore Ventilatore	28	HWX32012210238	Pannello destro
9	HWX32012210238	Pannello sinistro	29	HWX200011134	Compressore
10	HWX3212221173	Pannello di separazione	30	HWX3212221019	Pannello di protezione elettrica
11	HWX20013605	Pressostato Alta pressione	31	HWX32012210237	Telaio
12	HWX20003603	Pressostato Bassa pressione	32	HWX3212221176	Quadro elettrico
13	HWX321222039	Pannello ABS superiore	33	HWX20003619	Relè
14	HWX20011418	Valvola a 4 vie	34	HWX20003909	Morsettiera 2 connessioni
15	HWX20041446	Filtro ( $\Phi$ 9,7 - $\Phi$ 3,4)	35	HWX950531145	Scheda elettronica PC1000
16	HWX200014153	Valvola Shrader	36	HWX40003901	Morsettiera elettrica 5 connessioni
17	HWX321212002	Evaporatore	37	HWX200037006	Trasformatore 230V~/12V~
18	HWX200036005	Rivelatore di portata	38	HWX20003505	Condensatore compressore 60 $\mu$ F
19	HWX20003242	Sonda di temperatura	39	HWX20009909	Capillare
20	HWX20003242	Sonda di temperatura			

## 6. ALLEGATI (seguito)

---

### ECP 13

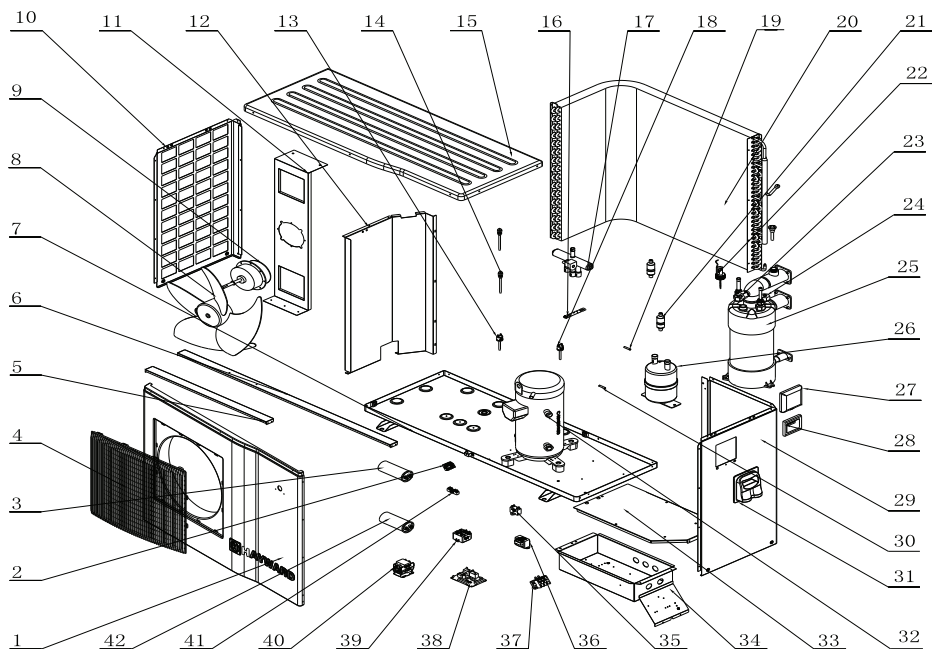



## 6. ALLEGATI (seguito)

### ECP 13

Num	Rif.	Descrizione	Num	Rif.	Descrizione
1	HWX32009210196	Pannello in ABS anteriore	23	HWX20003242	Sonda di temperatura
2	HWX20003933	Morsettiera 3 connessioni	24	HWX20003242	Sonda di temperatura
3	HWX20003524	Condensatore di avviamento CPS 98 $\mu$ F	25	HWX32091206	Condensatore Titanio/ PVC
4	HWX35122213	Griglia	26	HWX35001401	Accumulatore
5	HWX320921015	Rinforzo anteriore	27	HWX20002111	Protezione controller
6	HWX320921149	Rinforzo posteriore	28	HWX950531188	Controller a 7 segmenti
7	HWX32009210193	Telaio	29	HWX32009210194	Pannello destro
8	HWX35002701	Pala ventilatore	30	HWX20003242	Sonda di temperatura
9	HWX34043301	Motore Ventilatore	31	HWX32009220054	Maniglia
10	HWX32009210195	Pannello sinistro	32	HWX20011170	Compressore
11	HWX320921147	supporto motore	33	HWX320921152	Pannello di protezione elettrica
12	HWX320921148	Pannello di separazione	34	HWX320921151	Quadro elettrico
13	HWX20013605	Pressostato Alta pressione	35	HWX20003501	Condensatore ventilatore 3 $\mu$ F
14	HWX200014153	Valvola Shrader	36	HWX200037006	Trasformatore 230V~/12V~
15	HWX32009210197	Pannello ABS superiore	37	HWX20003920	Morsettiera 3 connessioni
16	HWX20001489	Limitatore	38	HWX950531145	Scheda elettronica PC1000
17	HWX20011491	Valvola a 4 vie	39	HWX20003676	Relè
18	HWX20003603	Pressostato Bassa pressione	40	HWX200036007	Contattore compressore
19	HWX20003242	Sonda di temperatura	41	HWX20003909	Morsettiera 2 connessioni
20	HWX351212001	Evaporatore	42	HWX20003510	Condensatore compressore 60 $\mu$ F
21	HWX20041444	Filtro (Ø9,7 - Ø9,7)	43	HWX20009909	Capillare
22	HWX200036005	Rivelatore di portata			

## 6. ALLEGATI (seguito)

---

ECP 15

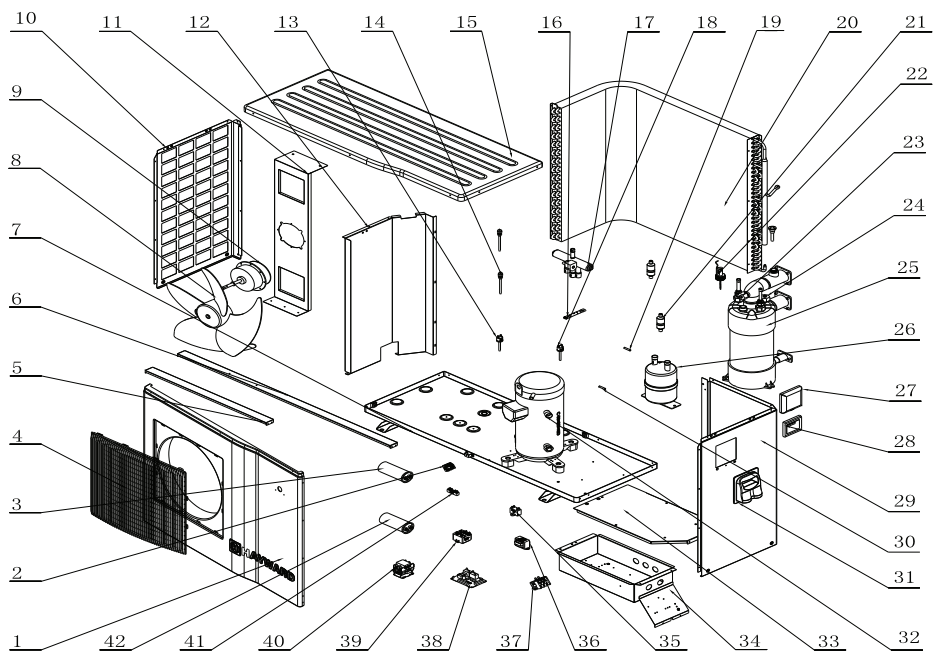

## 6. ALLEGATI (seguito)

### ECP 15

Num	Rif.	Descrizione	Num	Rif.	Descrizione
1	HWX32009210196	Pannello in ABS anteriore	23	HWX20003242	Sonda di temperatura
2	HWX20003933	Morsettiera 3 connessioni	24	HWX20003242	Sonda di temperatura
3	HWX20003524	Condensatore di avviamento CPS 98 $\mu$ F	25	HWX32091206	Condensatore Titanio/PVC
4	HWX35122213	Griglia	26	HWX35001401	Accumulatore
5	HWX320921015	Rinforzo anteriore	27	HWX20002111	Protezione controller
6	HWX320921149	Rinforzo posteriore	28	HWX950531188	Controller a 7 segmenti
7	HWX32009210193	Telaio	29	HWX32009210194	Pannello destro
8	HWX35002701	Pala ventilatore	30	HWX20003242	Sonda di temperatura
9	HWX34043301	Motore Ventilatore	31	HWX32009220054	Maniglia
10	HWX32009210195	Pannello sinistro	32	HWX20011169	Compressore
11	HWX320921147	supporto motore	33	HWX320921152	Pannello di protezione elettrica
12	HWX320921148	Pannello di separazione	34	HWX320921151	Quadro elettrico
13	HWX20013605	Pressostato Alta pressione	35	HWX20003501	Condensatore ventilatore 3 $\mu$ F
14	HWX200014153	Valvola Shrader	36	HWX200037006	Trasformatore 230V~/12V~
15	HWX32009210197	Pannello ABS superiore	37	HWX20003920	Morsettiera 3 connessioni
16	HWX20001489	Limitatore	38	HWX950531145	Scheda elettronica PC1000
17	HWX20011491	Valvola a 4 vie	39	HWX20003676	Relè
18	HWX20003603	Pressostato Bassa pressione	40	HWX200036007	Contattore compressore
19	HWX20003242	Sonda di temperatura	41	HWX20003909	Morsettiera 2 connessioni
20	HWX351212001	Evaporatore	42	HWX20003510	Condensatore compressore 60 $\mu$ F
21	HWX20041444	Filtro ( $\varnothing$ 9,7 - $\varnothing$ 9,7)	43	HWX20009909	Capillare
22	HWX200036005	Rivelatore di portata			

## 6. ALLEGATI (seguito)

### 6.4 Guida alla risoluzione dei problemi



**Alcune operazioni devono essere eseguite da un tecnico abilitato.**

Errore	Codici di errore	Descrizione	Soluzione
Errore sonda ingresso acqua	P01	Il sensore è aperto o presenta un cortocircuito.	Verificare o sostituire il sensore.
Errore sonda uscita acqua	P02	Il sensore è aperto o presenta un cortocircuito.	Verificare o sostituire il sensore.
Errore sonda temperatura esterna	P04	Il sensore è aperto o presenta un cortocircuito.	Verificare o sostituire il sensore.
Errore sonda di sbrinamento	P05	Il sensore è aperto o presenta un cortocircuito.	Verificare o sostituire il sensore.
Protezione alta pressione	E01	Pressione del circuito frigorifero troppo elevata, portata troppo bassa, evaporatore ostruito oppure portata d'aria troppo bassa.	Controllare il pressostato alta pressione e la pressione del circuito frigorifero. Controllare la portata d'acqua o d'aria. Controllare il corretto funzionamento del controller di portata. Controllare l'apertura delle valvole entrata/uscita d'acqua. Verificare la regolazione del bypass.
Protezione bassa pressione	E02	Pressione del circuito frigorifero troppo bassa, portata d'aria troppo bassa o evaporatore ostruito.	Controllare il pressostato bassa pressione e la pressione del circuito frigorifero per accertarsi che non vi siano perdite. Pulire la superficie dell'evaporatore. Controllare la velocità di rotazione del ventilatore. Controllare la libera circolazione dell'aria attraverso l'evaporatore.
Errore rivelatore di portata	E03	Portata d'acqua insufficiente oppure rivelatore in cortocircuito o difettoso.	Controllare la portata d'acqua, la pompa di filtrazione e il rivelatore di portata per assicurarsi che non presentino eventuali malfunzionamenti.
Differenza di temperatura troppo elevata tra l'acqua in uscita e l'acqua in ingresso	E06	Portata d'acqua volumetrica insufficiente, differenza di pressione d'acqua troppo bassa / troppo alta.	Controllare la portata d'acqua o eventuali ostruzioni del sistema.
Protezione antigelo Modalità freddo	E07	Quantità d'acqua in uscita troppo bassa.	Controllare la portata d'acqua oppure il sensore di temperatura dell'acqua in uscita.
Problema di comunicazione	E08	Malfunzionamento del controller LED o della connessione PCB.	Controllare la connessione dei cavi.
Protezione antigelo di livello 1	E19	Temperatura ambiente e dell'acqua in ingresso troppo bassa.	Arrestare la pompa di calore e svuotare il condensatore. Rischio di gelo.
Protezione antigelo di livello 2	E29	Temperatura ambiente e dell'acqua in ingresso ancora più bassa.	Arrestare la pompa di calore e svuotare il condensatore. Rischio di gelo.

## 6. ALLEGATI (seguito)

---

### 6.5 Garanzia

#### CONDIZIONI DI GARANZIA

Tutti i prodotti HAYWARD sono garantiti contro tutti i difetti di fabbricazione o di materiale per un periodo di due anni dalla data di acquisto. Le eventuali richieste garanzia dovranno essere accompagnate dalla prova di acquisto comprovante detta data. Si raccomanda pertanto di conservare la fattura.

La garanzia HAYWARD è limitata alla riparazione o alla sostituzione, a discrezione della stessa HAYWARD, dei prodotti difettosi solo ed esclusivamente in caso di normale utilizzo e in conformità alle prescrizioni riportate nel manuale d'uso del prodotto; sarà altresì riconosciuta valida, qualora il prodotto in questione non sia stato in alcun caso alterato ed utilizzato esclusivamente in abbinamento a parti e componenti HAYWARD. Gli eventuali danni dovuti a gelo e ad attacchi di agenti chimici non sono coperti da garanzia.

Ogni altra spesa (trasporto, manodopera...) è esclusa dalla garanzia.

HAYWARD declina ogni responsabilità per danni, diretti o indiretti, riconducibili a installazione, collegamento o utilizzo non corretti del prodotto.

Per richiedere un intervento in garanzia e la riparazione o la sostituzione di un componente, rivolgersi ad un rivenditore autorizzato. Salvo previo accordo scritto, gli eventuali resi saranno respinti.

I componenti soggetti ad usura non sono coperti dalla garanzia.

# EASY TEMP

VARMEPUMPE TIL SVØMMEBASSENG

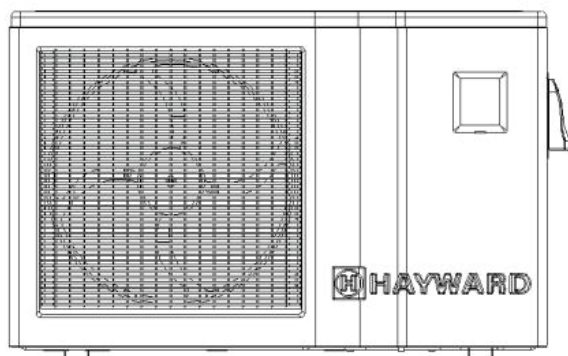

Installerings- og brukerveiledning

# INNHOLDSFORTEGNELSE

---

<b>1. Innledning</b>	<b>1</b>
<hr/>	
<b>2. Tekniske spesifikasjoner</b>	<b>2</b>
2.1 Tekniske opplysninger om varmepumpen	2
2.2 Driftsområde	3
2.3 Dimensjoner	4
<hr/>	
<b>3. Installasjon og tilkoping</b>	<b>5</b>
3.1 Prinsipptegning	5
3.2 Varmepumpe	5
3.3 Vanntilkopling	6
3.4 Elektrisk tilkoping	7
3.5 Første idriftsetting	8
3.6 Regulering av vannstrømmen	10
<hr/>	
<b>4. Brukergrensesnitt</b>	<b>11</b>
4.1 Generell presentasjon	11
4.2 Innstilling av klokkeslett	13
4.3 Innstilling av Timer-funksjonen	13
4.4 Valg av driftsmodus: oppvarming eller kjøling	14
4.5 Innstilling og visning av settpunkt	15
4.6 Låse og låse opp brukergrensesnittet	15
<hr/>	
<b>5. Vedlikehold og vinterklargjøring</b>	<b>16</b>
5.1 Vedlikehold	16
5.2 Vinterklargjøring	16
<hr/>	
<b>6. Vedlegg</b>	<b>17</b>
6.1 Koplingsdiagrammer	17
6.2 Koplinger for oppvarmingsvarmeprioritet	22
6.3 Sprengskisser og reservedeler	23
6.4 Veiledning for feilsøking	33
6.5 Garanti	34

Må leses nøye og oppbevares for senere bruk.

Dette dokumentet må overleveres eieren av svømmebassenget, som må oppbevare det på et sikkert sted.

# 1. INNLEDNING

---

Takk for at du valgte denne Easy Temp varmpumpen for svømmebasseng. Dette produktet er blitt fremstilt i samsvar med strenge fabrikkasjonsstandarder for å tilfredsstille de påkrevde kvalitetsnivåene. Denne veiledningen inneholder alle nødvendige opplysninger angående installasjon, løsning av driftsproblemer og vedlikehold. Les veiledningen nøye før du åpner enheten eller utfører vedlikeholdsoperasjoner på den. Fabrikanten av dette produktet vil ikke i noen tilfeller bli holdt ansvarlig i tilfelle skade på brukeren eller forringelse av enheten som en følge av eventuelle feil ved installasjon, løsning av driftsproblemer eller unødvendig vedlikehold. Det er svært viktig at instruksene i denne veiledningen blir nøye etterfulgt på ethvert tidspunkt. Enheten må installeres av kvalifiserte personer.

- Reparasjonene må utføres av kvalifiserte personer.
- Alle elektriske tilkoblinger må utføres av en profesjonell, kvalifisert elektriker, og i overensstemmelse med gjeldende standarder i det landet hvor enheten installeres, jfr. § 3.4.
- Vedlikeholdet og de ulike operasjonene må utføres med de anbefalte hyppighetene og på de anbefalte tidspunktene, slik det blir spesifisert i denne veiledningen.
- Det må kun brukes originale reservedeler.
- Enhver anbefaling som ikke blir etterfulgt, vil oppheve garantien.
- Denne varmpumpen varmer opp vannet i svømmebassenget, og opprettholder konstant temperatur. Den må ikke brukes til andre formål.

Etter å ha lest denne veiledningen, ta vare på den med tanke på senere bruk. Advarsler med hensyn til barn / personer med redusert fysisk kapasitet: Dette apparatet er ikke beregnet på å bli brukt av personer (spesielt barn) med nedsatt fysisk, sensorisk eller intellektuell kapasitet, eller av personer med manglende erfaring eller kunnskaper med mindre disse er under oppsyn av, eller har fått opplæring i bruken av apparatet av en person som er ansvarlig for deres sikkerhet.

Dette produktet inneholder fluorholdige klimagasser som er berammet av Kyoto-protokollen.

Type kuldemedium: R410A

GWP-verdi<sup>(1)</sup>: 1975

Periodiske inspeksjoner av lekkasje av kuldemedium kan være påkrevet avhengig av europeisk eller lokalt regelverk. Vennligst ta kontakt med din lokale forhandler for ytterligere informasjon.

---

(1) Global warming potential



## 2. TEKNISKE SPESIFIKASJONER

### 2.1 Tekniske opplysninger om varmpumpen

Modell	EASY TEMP	ECP 06	ECP 08	ECP 11	ECP 13	ECP 15
Varmekapasitet *	kW BTU/h	5,5 18785	8 27322	11 37566	13.5 46105	15 51228
Elektrisk effekt	kW	1,17	1,8	2,43	3	3,13
Driftsstrøm *	A	5,19	7,91	11,81	14,5	16
Elektrisk strømtilførsel	V Ph/Hz	230 V~ 1/50 Hz	230 V~ 1/50 Hz	230 V~ 1/50 Hz	230 V~ 1/50 Hz	230 V~ 1/50 Hz
Sikringskaliber av typen aM	A	8 aM	10 aM	16 aM	20aM	20 aM
Effektbryter kurve D	A	8 D	10 D	16 D	20 D	20 D
Antall kompressorer		1	1	1	1	1
Kompressortype		Roterende	Roterende	Roterende	Scroll	Scroll
Antall vifter		1	1	1	1	1
Viftens effekt	W	50	120	120	120	120
Viftens rotasjonshastighet	RPM	770	850	850	850	850
Vifteretning		Horisontal	Horisontal	Horisontal	Horisontal	Horisontal
Lydtryknivå (ved 1 meter)	dB(A)	47	51	54	56	56
Vanntilkopling	mm	50	50	50	50	50
Vannsirkulasjonsmengde	m <sup>3</sup> /h	2,3	3,0	4,5	5,3	6,6
Fall i vanntrykk (maks.)	kPa	5,4	8,9	19,2	5.2	39,9
Enhetens nettodimensjoner (L//h)	mm	895/375/545	1035/415/650	1035/415/650	1136/440/870	1136/440/870
Enhetens forsendelsesdimensjoner (L//h)	mm	970/430/710	1120/480/810	1180/480/810	1230/510/1020	1230/510/1020
Nettovekt / forsendelsesvekt	kg	45/56	54/68	60/74	95/115	117/128



\* Verdi på +/- 5% under følgende betingelser: Utendørs temperatur = 24°C (75°F) / HR=62% / Bassengtemperatur=27°C (80°F)

## 2. TEKNISKE SPESIFIKASJONER (fortsettelse)

---

### 2.2 Driftsområde

Bruk varmepumpen i de følgende temperatur- og fuktighetsområdene for å sikre en trygg og effektiv drift.

	Oppvarmingsmodus 	Kjølemodus 
Utendørs temperatur	+2°C ~ +35°C	+7°C ~ +43°C
Vanntemperatur	+12°C ~ +40°C	+8°C ~ +40°C
Relativ fuktighet	< 80%	< 80%
Innstillingsområde for settpunkt	+15°C ~ +40°C	+8°C ~ +35°C



***Hvis temperatur eller luftfuktighet ikke samsvarer med disse betingelsene, kan sikkerhetsanordninger aktiveres og varmepumpen slutte å fungere.***

## 2. TEKNISKE SPESIFIKASJONER (fortsettelse)

### 2.3 Dimensjoner

Modeller: ECP06 / ECP08 / ECP11 / ECP13 / ECP15

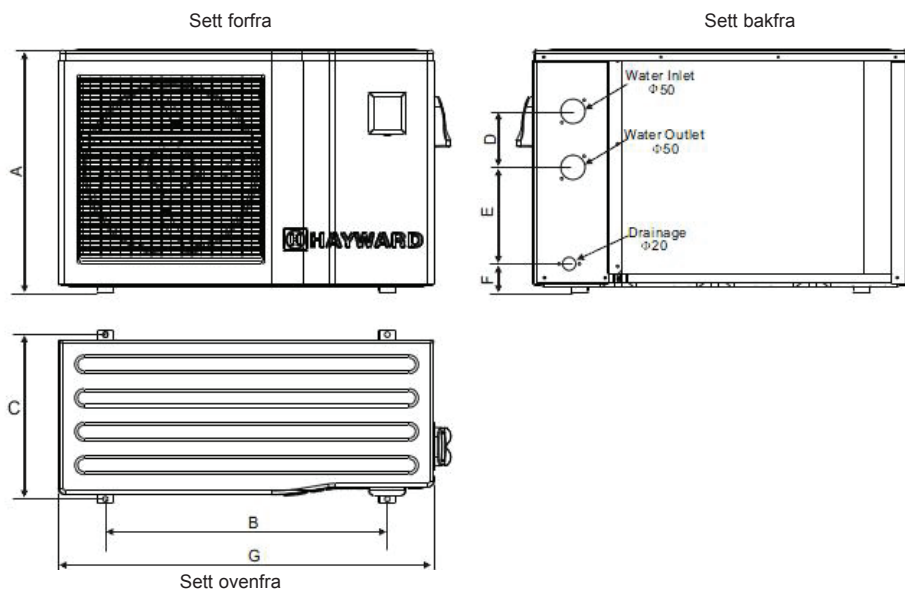

Enhet: mm

Modell Nummer	ECP06	ECP08 ECP11	ECP13 ECP15
<b>A</b>	540	648	866
<b>B</b>	571	755	840
<b>C</b>	400	440	470
<b>D</b>	140	150	150
<b>E</b>	258	258	330
<b>F</b>	66	77	80
<b>G</b>	860	1004	1114

## 3. INSTALLASJON OG TILKOPLING

### 3.1 Prinsipp tegning

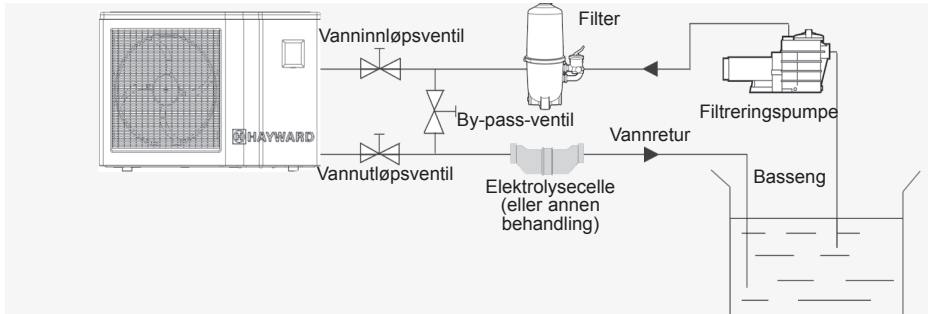

Merk: Varmepumpen leveres uten noe rense- eller filteringsutstyr. Elementene som vises på tegningen, er deler som må leveres av installatøren.

### 3.2 Varmepumpe



**Plasser varmpumpen utendørs, og ikke inne i lukkede, tekniske lokaler.**

**Varmepumpen må plasseres under beskyttelse, og minsteavstandene som er nevnt nedenfor må overholdes for å unngå resirkulering av luft, og forringelse av varmpumpens globale ytelser.**

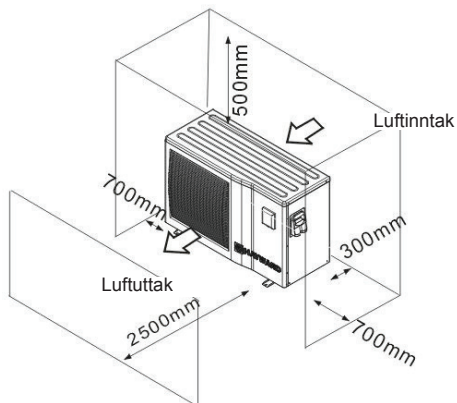

### 3. INSTALLASJON OG TILKOPLING (fortsettelse)

---



*Installer varmpumpen helst på en frittliggende betonplate, eller et spesielt feste som er forutsett til dette, og monter varmpumpen på de medfølgende Silentbloc-underlagene (skruer og skiver er ikke inkludert).*

*Maksimal installasjonsavstand mellom varmpumpen og bassenget er 15 meter.*

*Total tur-returlengde for vannkanalene er 30 meter.*

*Isoler vannkanalene på bakken og under jorden.*

#### 3.3 Vanntilkopling

Varmpumpen leveres med to koplingsforbindelser med diameter 50 mm. Bruk PVC-rør til det vannrørsystemet med Ø 50 mm. Kople varmpumpens vanninnløp til røret som kommer fra filteringsgruppen, og kople deretter varmpumpens vannutløp til vannrøret som går til bassenget (jfr. tegning nedenfor).

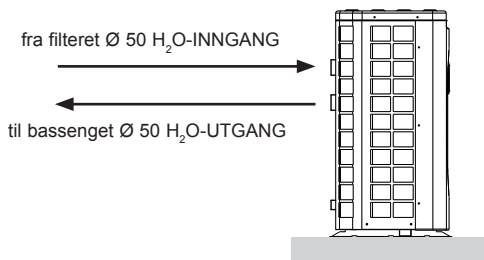

Installere en såkalt “by-pass”-ventil mellom varmpumpens innløp og utløp.



*Dersom automatisk fordeler eller elektrolysecelle blir benyttet, må denne være installert etter varmpumpen for å beskytte Titanium-kondensatoren mot en for stor konsentrasjon av kjemiske stoffer.*



*Sørg for å installere by-pass-ventilen og de medfølgende koplingsdelene ved enhetens vanninnløp og –utløp, for å forenkle tømning om vinteren, og gjøre tilgang eller demontering for vedlikehold enklere.*

## 3. INSTALLASJON OG TILKOPLING (fortsettelse)

### 3.4 Elektrisk tilkopling



**Den elektriske installasjonen og kablingen av dette utstyret må være i overensstemmelse med gjeldende, lokale installasjonsforskrifter.**

F	NF C15-100	GB	BS7671:1992
D	DIN VDE 0100-702	EW	EVHS-HD 384-7-702
A	ÖVE 8001-4-702	H	MSZ 2364-702/1994/MSZ 10-553 1/1990
E	UNE 20460-7-702 1993, RECBT ITC-BT-31 2002	M	MSA HD 384-7-702.S2
IRL	Wiring Rules + IS HD 384-7-702	PL	PN-IEC 60364-7-702:1999
I	CEI 64-8/7	CZ	CSN 33 2000 7-702
LUX	384-7.702 S2	SK	STN 33 2000-7-702
NL	NEN 1010-7-702	SLO	SIST HD 384-7-702.S2
P	RSIUEE	TR	TS IEC 60364-7-702



**Kontroller at den tilgjengelige strømtilførselen og nettfrekvensen stemmer overens med kravene for driftsstrøm, og tar hensyn til den spesifikke plasseringen av apparatet, og nødvendig strøm for å forsyne andre apparater som er koplet til samme krets.**

**ECP 06 230 V~ +/- 10 % 50 HZ 1 Fase**

**ECP 08 230 V~ +/- 10 % 50 HZ 1 Fase**

**ECP 11 230 V~ +/- 10 % 50 HZ 1 Fase**

**ECP 13 230 V~ +/- 10 % 50 HZ 1 Fase**

**ECP 15 230 V~ +/- 10 % 50 HZ 1 Fase**

**Se tilsvarende koplings skjema i vedlegg.**

**Koplingsboksen befinner seg på enhetens høyre side. Tre tilkoplinger er til strømforsyning, og to til styring av filtreringspumpen (servomekanisme).**

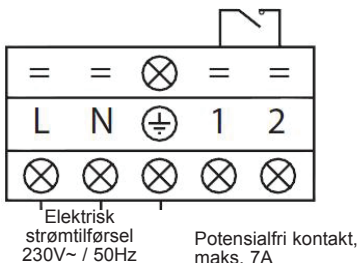

### 3. INSTALLASJON OG TILKOPLING (fortsettelse)

---



*Strømledningen skal på egnet måte være utstyrt med en anordning med sikringsvern av typen motortilførsel (aM) eller en effektbryter kurve D samt en 30mA jordfeilbryter (se tabell nedenfor).*

Modeller		ECP 06	ECP 08	ECP 11	ECP 13	ECP 15
Elektrisk strømtilførsel	V/Ph/ Hz	230 V~ 1/50 Hz	230 V~ 1/50 Hz	230 V~ 1/50 Hz	230 V~ 1/50 Hz	230 V~ 1/50 Hz
Sikringskaliber av typen aM	A	8 aM	10 aM	16 aM	20 aM	20 aM
Effektbryter kurve D	A	8 D	10 D	16 D	20 D	20 D



*Pass alltid på å slå av hovedstrømtilførselen før du åpner den elektriske kontrollboksen.*

#### 3.5 Første idriftsetting

Startprosedyre – når installasjonen er ferdig, følg og overhold følgende etapper:

- 1) Roter viften for hånd for å sjekke at den beveger seg fritt, og at rotoren er riktig festet på motorakselen.
- 2) Forsikre deg om at enheten er koplet riktig til hovedstrømtilførselen (se vedlagt koplingskjema).
- 3) Slå på filtreringspumpen.
- 4) Sjekk at alle vannventilene er åpne, og at vannet renner inn i enheten før varme- eller kjølemodus skrur på.
- 5) Sjekk at kondensatutløpet er festet riktig, og er fri for blokkeringer.
- 6) Slå på strømtilførselen til enheten, og trykk deretter på START-/STOPP-knappen  på kontrollpanelet.
- 7) Se til at ingen ALARMkode vises når enheten er PÅ (se veiledning for feilsøking).

### 3. INSTALLASJON OG TILKOPLING (fortsettelse)

---

- 8) Fastsett vannstrømmen med by-pass-ventilen (se § 3.6 og 2.1), som forutsett for hver modell, slik at det oppnås en forskjell på Innløps-/ Utløpstemperatur på 2°C.
- 9) Etter noen minutters drift, sjekk at luften som kommer ut av enheten er blitt kjøligere (mellom 5 og 10°).
- 10) Slå av filtreringspumpen mens enheten er i drift. Enheten skal slå seg automatisk av og vise feilkoden E03.
- 11) La enheten og bassengpumpen være i drift hele døgnet helt til ønsket vanntemperatur er nådd. Enheten slås av

når bestemt temperatur for vanninnløp av nådd. Enheten vil nå automatisk restarte (så lenge bassengpumpen er i drift) når vanntemperaturen blir lavere enn 0,5 °C enn bestemt temperatur.

**Vannsirkulasjonskontroller** – Enheten er utstyrt med en vannsirkulasjonskontroller som aktiverer bassengpumpen når filtreringspumpen er på, og slår den av når filtreringspumpen ikke er i drift. Hvis vannivået i bassenget er for lavt, vises alarmkoden E03 på regulatoren (Se § 6.4).

**Tidsforsinkelse** - enheten er utstyrt med en innebygd 3-minutters tidsforsinkelse for å beskytte kontrollkretsens deler, og for å fjerne ustabilitet ved omstart, samt all interferens ved kontaktoeren. Takket være denne tidsforsinkelsen, vil enheten starte automatisk igjen

ca. 3 minutter etter hvert avbrudd av kontrollkretsen. Selv et kort strømavbrudd vil aktivere denne tidsforsinkelsen.



### 3. INSTALLASJON OG TILKOPLING (fortsettelse)

#### 3.6 Innstilling av vannstrømmen

Når varmepumpen er i drift, og ventilene for vanninnløp og –utløp er åpne, still inn den såkalte “by-pass”-ventilen slik at det oppnås en forskjell på 2°C mellom vanninnløpet og-utløpet (se prinsipptegning § 3.1). Du kan kontrollere innstillingen ved å vise temperaturene for innløp (T02) / utløp (T03) direkte på kontrollpanelet ved å følge prosedyren nedenfor.

Still deretter inn by-pass-ventilen for å oppnå en forskjell på 2°C mellom T03

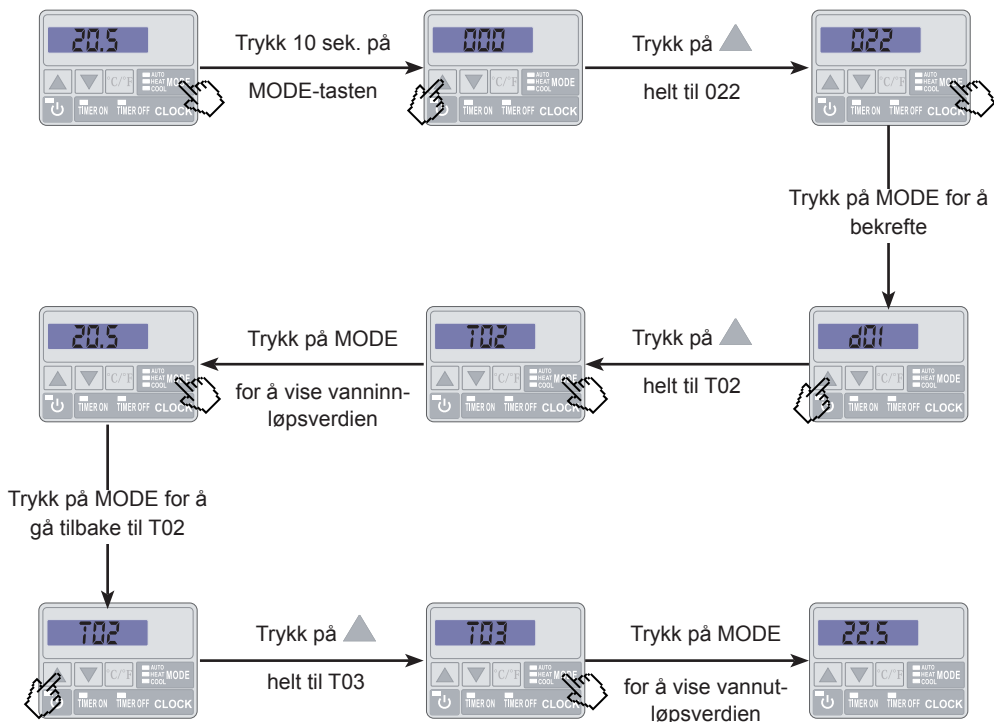

og T02 ( $T03 - T02 = \Delta T = 2$ ).

Trykk 2 ganger på  for å gå ut av menyen

Merk: Når den såkalte “by-pass”-ventilen åpnes, fører det til mindre vannmengde, og dermed en økning av  $\Delta T$ .

Når den såkalte “by-pass”-ventilen lukkes, fører det til større vannmengde, og dermed en senking av  $\Delta T$ .

## 4. BRUKERGRENSESNITT







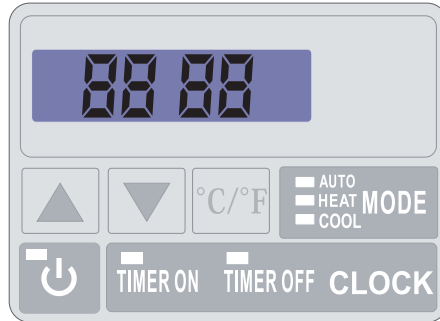



---

### 4.1 Generell oversikt

Varmepumpen er utstyrt med et elektronisk kontrollpanel, elektrisk tilkopleet og forhåndsinnstilt i fabrikk til varmedrift.



#### Tegnforklaring

-  **COOL** Symbol Kjølemodus
-  **HEAT** Symbol Oppvarmingsmodus
-  **AUTO** Automatisk modus
-  **CLOCK** Innstilling av klokkeslett og Timer
-  **MODE** Knapp for valg og innstilling
-  **Start-/Stopp-knapp og tilbake/bekreft**
-  **Rull ned**
-  **Rull opp**
-  **TIMER ON** Innstilling av startklokkeslett
-  **TIMER OFF** Innstilling av stoppklokkeslett

## 4. BRUKERGRENSESNITT (fortsettelse)

---

### OFF-modus

Når varmepumpen er i standby (OFF-modus), vil klokkeslett og driftsmodus vises på regulatorskjermen.

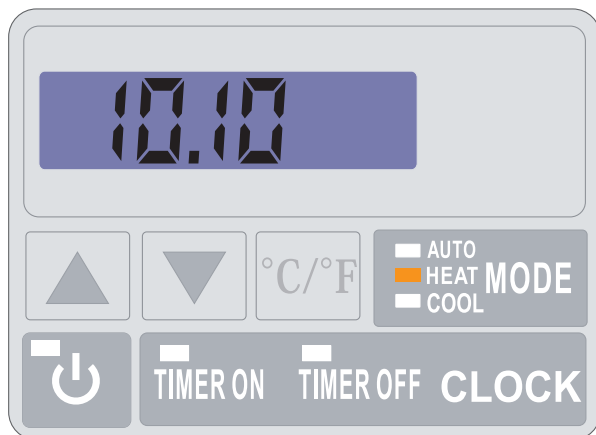

### ON-modus



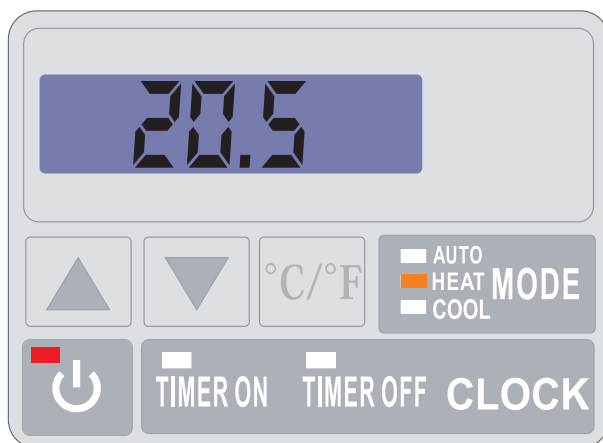

Når varmepumpen er i drift eller under innstilling (ON-modus), lyser ON-knappen rødt og temperaturen for vanninnløp vises på skjermen.



## 4. BRUKERGRENSESNITT (fortsettelse)

---

### 4.2 Innstilling av klokkeslett





Innstillingen av klokkeslettet kan gjøres i både ON- og OFF-modus. Trykk på «CLOCK», visningen blinker. Trykk deretter på «CLOCK» igjen, timene blinker. Still inn timen med pilene.  Eller,  trykk nok en gang på «CLOCK» for å velge minuttene. Still inn minuttene med pilene.  Eller, . Trykk på «CLOCK» for å bekrefte. Skjermen går tilbake til sin forrige status.

Merk: Innstillingene lagres med tasten «CLOCK» eller automatisk dersom ingen tast blir trykket inn i løpet av 5 sekunder.

### 4.3 Innstilling av Timer-funksjonen





Denne funksjonen må stilles inn når du ønsker å sette varmpumpen i drift over en kortere periode enn den som er definert av filtreringstimeren. På denne måten kan du programmere en forsinket start og en tidligere stans, eller helt enkelt forby et tidsområde for drift (for eksempel om natten).

#### Programmere Start (Timer ON) / Start

- 1) Trykk på «Timer ON», klokkeslettet blinker.
- 2) Trykk på «Timer ON» for stille inn timene med tastene  .
- 3) Trykk på «Timer ON» for å stille inn minuttene med tastene  .

Innstillingene lagres med tasten «Timer ON» eller automatisk dersom ingen tast blir trykket inn i løpet av 5 sekunder. En grønn lampe angir at timeren er aktivert.

#### Programmere Stans (Timer OFF) / Stans



- 1) Trykk «Timer OFF», klokkeslettet blinker.
- 2) Trykk på «Timer OFF» for å stille inn timene med tastene  .
- 3) Trykk på «Timer OFF» for å stille inn minuttene med tastene  .

Innstillingene lagres med tasten «Timer OFF» eller automatisk dersom ingen tast blir trykket inn i løpet av 5 sekunder. En rød lampe angir at timeren er aktivert.

## 4. BRUKERGRENSESNITT (fortsettelse)

---

### Slette Timer (Timer ON og OFF) / Stans og Start

- 1) Trykk på «Timer ON», «Timer ON» blinker.
- 2) Trykk på  for å slette programmeringen.
- 3) Trykk på «Timer OFF», «Timer OFF» blinker.
- 4) Trykk på  for å slette programmeringen.

### 4.4 Valg av driftsmodus: Oppvarming, kjøling eller automatisk.

#### I modus “OFF” eller “ON”

Trykk på tasten «MODE» for å veksle fra kjøling (grønn lampet) til oppvarming (oransje lampe) eller til automatisk modus (rød lampe).





## 4. BRUKERGRENSESNITT (fortsettelse)

---



### 4.5 Innstilling og visning av settpunkt (ønsket vanntemperatur)

I modus “OFF” og modus “ON”

Trykk på tastene  Eller,  For å definere ønsket settpunkt. Innstillingen foretas med en nøyaktighet på 0,5 °C.



*Det anbefales å aldri overstige en temperatur på 30°C for å unngå forringelse av liners.*

Merk: I drift eller i stans, er det nok å trykke på tasten  eller  for å vise eller endre settpunktet.

### 4.6 Låse og låse opp berøringsskjermen

Trykk på Start-/Stopknappen  i 5 sek. helt til det høres en pipelyd.

Tastene blir uvirksomme.

For å låse opp, trykk på  i 5 sek. helt til det høres en pipelyd.

Tastene blir på nytt aktive.

## 5. VEDLIKEHOLD OG VINTERKLARGJØRING

---

### 5.1 Vedlikehold

Disse vedlikeholdsoperasjonene må utføres 1 gang i året for å sikre lang levetid og god drift av varmpumpen.

- Rengjør fordampere med en myk børste eller med en luft- eller vannstråle (**NB! Bruk aldri høytrykksspyler**).
- Kontroller evakueringen av kondensater.
- Kontroller at elektriske og hydrauliske koplinger sitter godt.
- Kontroller vanntettheten til kondensatoren.



***Før alt vedlikehold må varmpumpen være frakoplet alle strømkilder. Vedlikeholdsoperasjonene skal kun utføres av kvalifisert personell med kompetanse til å håndtere kuldemedier.***

### 5.2 Vinterklargjøring

- Sett varmpumpen i "OFF"-modus.
- Slå av strømtilførselen til varmpumpen.
- Tøm kondensatoren ved hjelp av tømmeventilen for å unngå fare for forringelse. (Stor risiko for frost).
- Steng "by-pass"-ventilen og skru løs koplingsdelene for vanninnløp/-utløp.
- Fjern maksimalt med stillestående vann som er igjen i kondensatoren ved hjelp av en blåsepistol.
- Tett igjen varmpumpens vanninnløp og -utløp for å forhindre fremmedlegemer i å trenge seg inn.
- Dekk til varmpumpen med et vintertrekk (leveres ikke med).



***Alle skader som er forårsaket av dårlig vinterklargjøring, vil oppheve garantien.***

# 6. VEDLEGG

## 6.1 Koplings-skjemaer

ECP 06

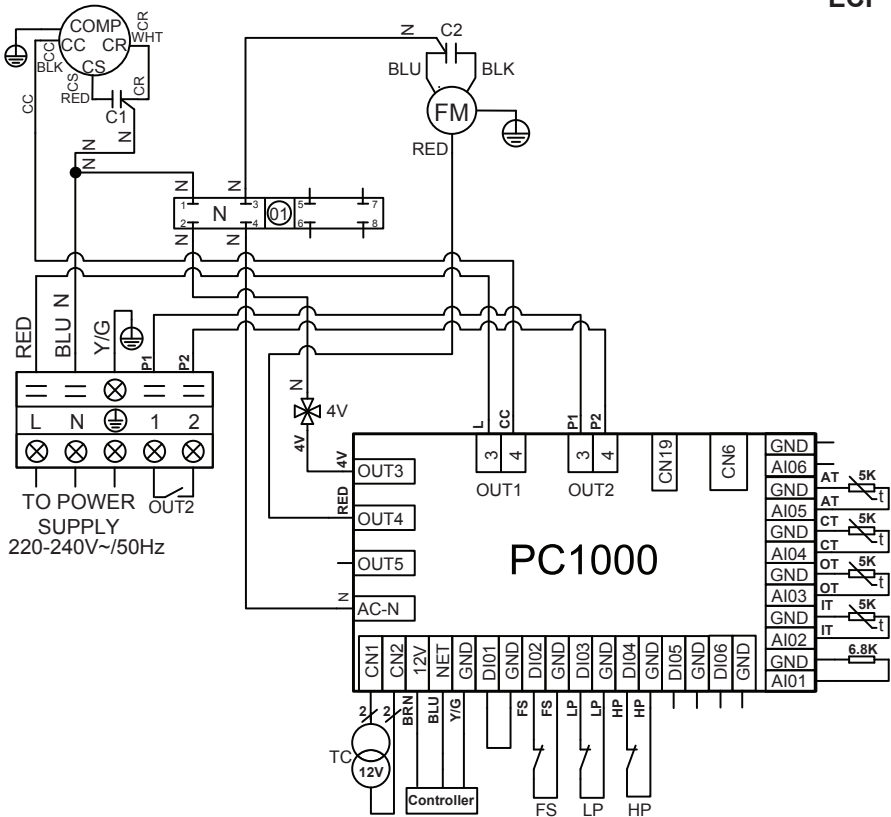

**MERKNADER:**  
 AT: LUFTEMPERATURSONDE  
 COMP: KOMPRESSOR  
 CT: FORDAMPERTEMPERATURSONE  
 FM: MOTORVIFTE  
 FS: VANNSENSOR  
 HP: HØYTRYKKSPESSOSTAT  
 IT: TEMPERATURSONDE VANNINNLØP  
 LP: LAVTRYKKSPESSOSTAT

OT: TEMPERATURSONDE VANNUTLØP  
 TC: TRANSFORMATOR 230V~/ 12V~  
 4V: 4-VEIS VENTIL  
 C1: KOMPRESSORKONDENSATOR  
 C2: VIFTEKONDENSATOR  
 OUT2 : POTENSIALFRI KONTAKT, MAKS. 7A



## 6. VEDLEGG (fortsettelse)

ECP 08

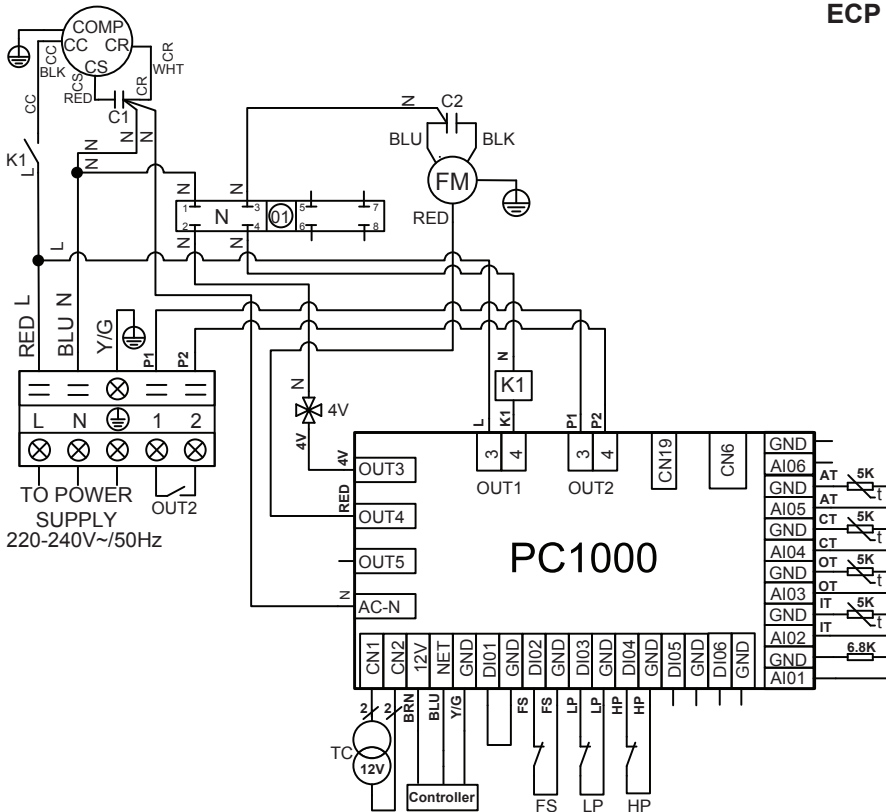

### MERKNADER:

AT: LUFTEMPERATURSONDE  
 COMP: KOMPRESSOR  
 CT: FORDAMPERTEMPERATURSONE  
 FM: MOTORVIFTE  
 FS: VANNSENSOR  
 HP: HØYTRYKSPRESSOSTAT  
 IT: TEMPERATURSONDE VANNINNLØSE

LP: LAVTRYKSPRESSOSTAT  
 OT: TEMPERATURSONDE VANNUTLØP  
 TC: TRANSFORMATOR 230V~/ 12V~  
 4V: 4-VEIS VENTIL  
 K1: KOMPRESSORRELE  
 C1: KOMPRESSORKONDENSATOR  
 C2: VIFTEKONDENSATOR  
 OUT2 : POTENSIALFRI KONTAKT, MAKS. 7A

# 6. VEDLEGG (fortsettelse)

ECP 11

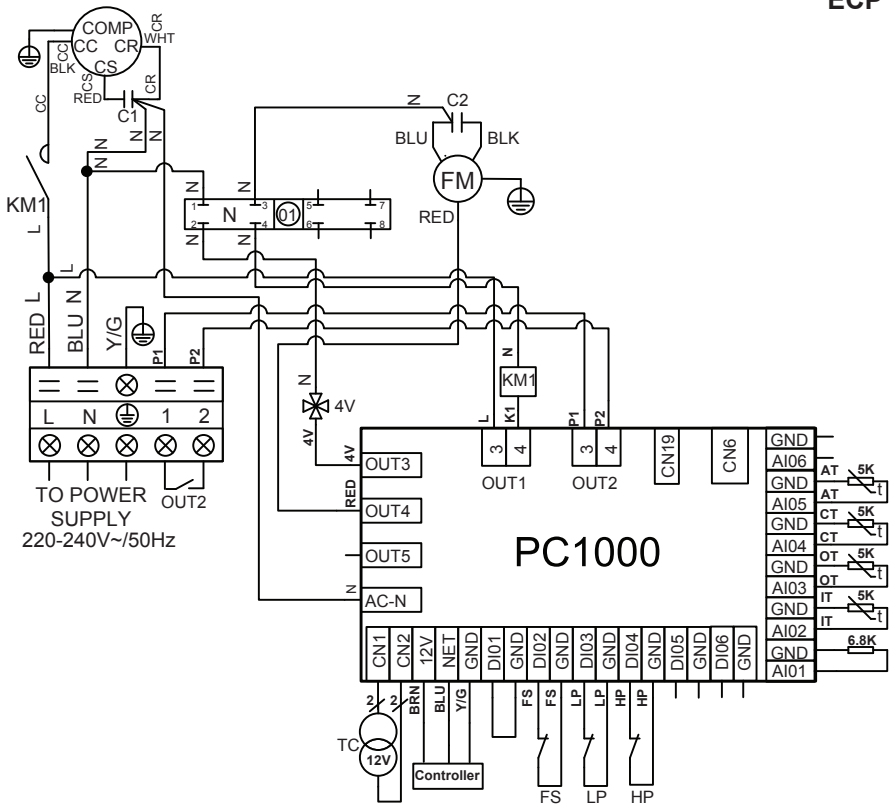

- MERKNADER:**  
 AT: LUFTEMPERATURSONDE  
 COMP: KOMPRESSOR  
 CT: FORDAMPERTEMPERATURSONE  
 FM: MOTORVIFTE  
 FS: VANNSENSOR  
 HP: HØYTRYKKSPESSOSTAT  
 IT: TEMPERATURSONDE VANNINNLØP

- OT: TEMPERATURSONDE VANNUTLØP  
 TC: TRANSFORMATOR 230V~ / 12V~  
 4V: 4-VEIS VENTIL  
 KM1: EFFEKTKONTAKTOR KOMPRESSOR  
 C1: KOMPRESSORKONDENSATOR  
 C2: VIFTEKONDENSATOR  
 OUT2 : POTENSIALFRI KONTAKT, MAKS. 7A

LP: LAVTRYKKSPESSOSTAT

## 6. VEDLEGG (fortsettelse)

ECP 13

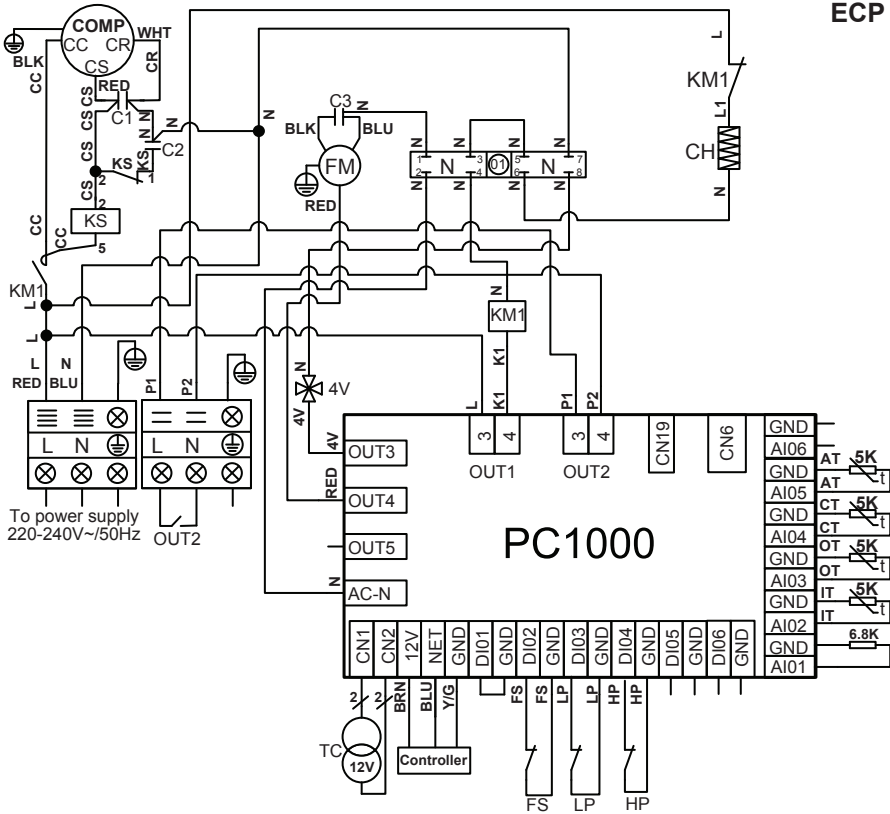

### MERKNADER:

AT: LUFTEMPERATURSONDE  
 COMP: KOMPRESSOR  
 CH: BUNNKASSEVARMER  
 CT: FORDAMPERTEMPERATURSONE  
 FM: MOTORVIFTE  
 FS: VANNSENSOR  
 HP: HØYTRYKKSRESSOSTAT  
 IT: TEMPERATURSONDE VANNINNLØP

LP: LAVTRYKKSRESSOSTAT  
 OT: TEMPERATURSONDE VANNUTLØP  
 TC: TRANSFORMATOR 230V~ / 12V~  
 4V: 4-VEIS VENTIL  
 KM1: EFFEKTKONTAKTOR KOMPRESSOR  
 C1: PERMANENT KONDENSATOR  
 C2: STARTKONDENSATOR  
 OUT2 : POTENSIALFRI KONTAKT, MAKS. 7A

KS: RELE-SPOLE TIL START AV KOMPRESSOR

## 6. VEDLEGG (fortsettelse)

ECP 15

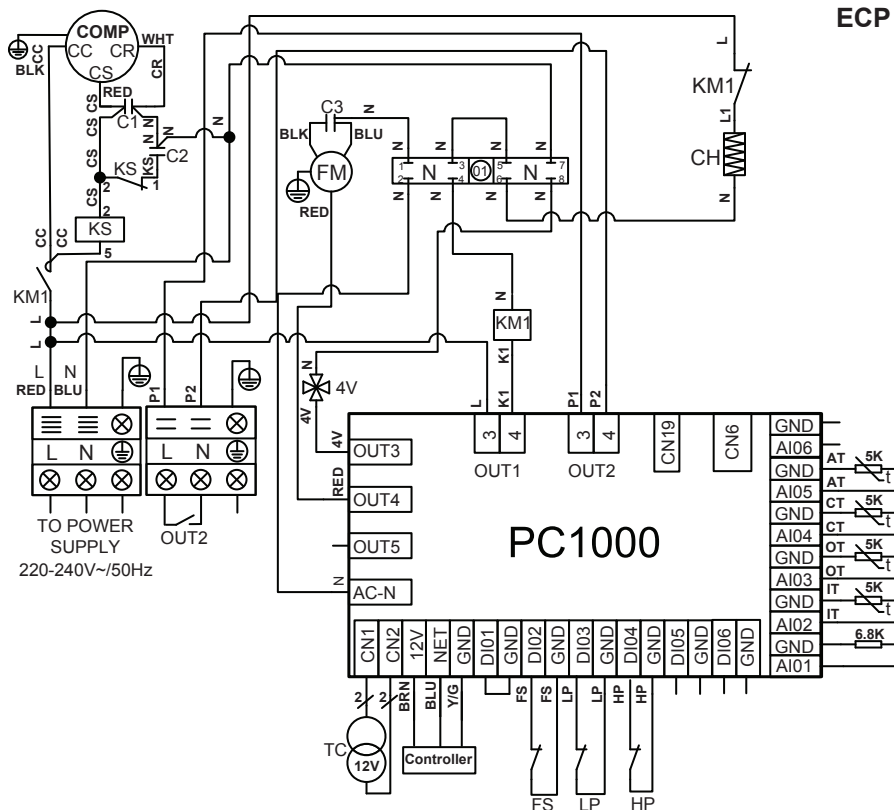

### MERKNADER:

AT: LUFTEMPERATURSONDE  
 COMP: KOMPRESSOR  
 CH: BUNNKASSEVARMER  
 CT: FORDAMPERTEMPERATURSONE  
 FM: MOTORVIFTE  
 FS: VANNSENSOR  
 HP: HØYTRYKKSPESSOSTAT  
 IT: TEMPERATURSONDE VANNINNØP

KS: RELE-SPOLE TIL START AV KOMPRESSOR

LP: LAVTRYKKSPESSOSTAT  
 OT: TEMPERATURSONDE VANNUTLØP  
 TC: TRANSFORMATOR 230V~/12V~  
 4V: 4-VEIS VENTIL  
 KM1: EFFEKTKONTAKTOR KOMPRESSOR  
 C1: PERMANENT KONDENSATOR  
 C2: STARTKONDENSATOR  
 OUT2 : POTENSIALFRI KONTAKT, MAKS. 7A



## 6. VEDLEGG (fortsettelse)

### 6.3 Sprengskisser og reservedeler

ECP 06

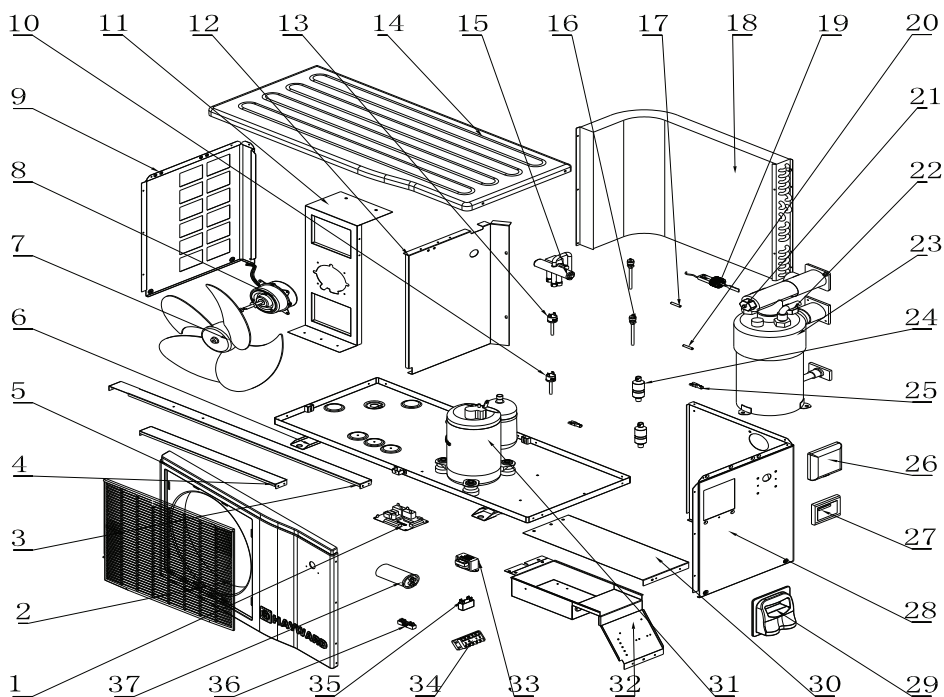

## 6. VEDLEGG (fortsettelse)

---

### ECP 06

Nr.	Ref.	Betegnelse	Nr.	Ref.	Betegnelse
1	HWX950531145	Elektronisk kort PC1000	20	HWX20003242	Temperatursonde
2	HWX35252208	Rist	21	HWX20003242	Temperatursonde
3	HWX322521062	Bakre støttelist	22	HWX20003242	Temperatursonde
4	HWX322521063	Fremre støttelist	23	HWX32251210	Kondensator Titanium/ PVC
5	HWX32025210084	Fremre ABS-panel	24	HWX20041444	Filter (Ø9.7-Ø9.7)
6	HWX32025210081	Understell	25	HWX200014068	Kapillærkopling
7	HWX34012701	Vifteblad	26	HWX20002111	Kontroller-deksel
8	HWX34013301	Viftemotor	27	HWX950531188	Kontroller 7 segmenter
9	HWX32025210083	Venstre panel	28	HWX32025210082	Høyre panel
10	HWX20003603	Lavtrykkspressostat	29	HWX32009220054	Håndtak
11	HWX322521061	Motorstøtte	30	HWX322521064	Panel til elektrisk beskyttelse
12	HWX322521059	Skillepanel	31	HWX200011006	Kompressor
13	HWX20013605	Høytrykkspressostat	32	HWX322521006	Strømboks
14	HWX32025210085	Øvre ABS-panel	33	HWX200037006	Transformator 230V~/12V~
15	HWX20011418	4-veis ventil	34	HWX40003901	Terminal 5 tilkoplinger
16	HWX200014153	Valve Shrader	35	HWX20003506	Viftekondensator 2µF
17	HWX20003242	Temperatursonde	36	HWX20003909	Terminal 2 tilkoplinger
18	HWX40001230	Fordamper	37	HWX20003504	Kompressorkondensator 35µF
19	HWX200036005	Vannstrømningssensor	38	HWX20009910	Kapillær

## 6. VEDLEGG (fortsettelse)

---

### ECP 08

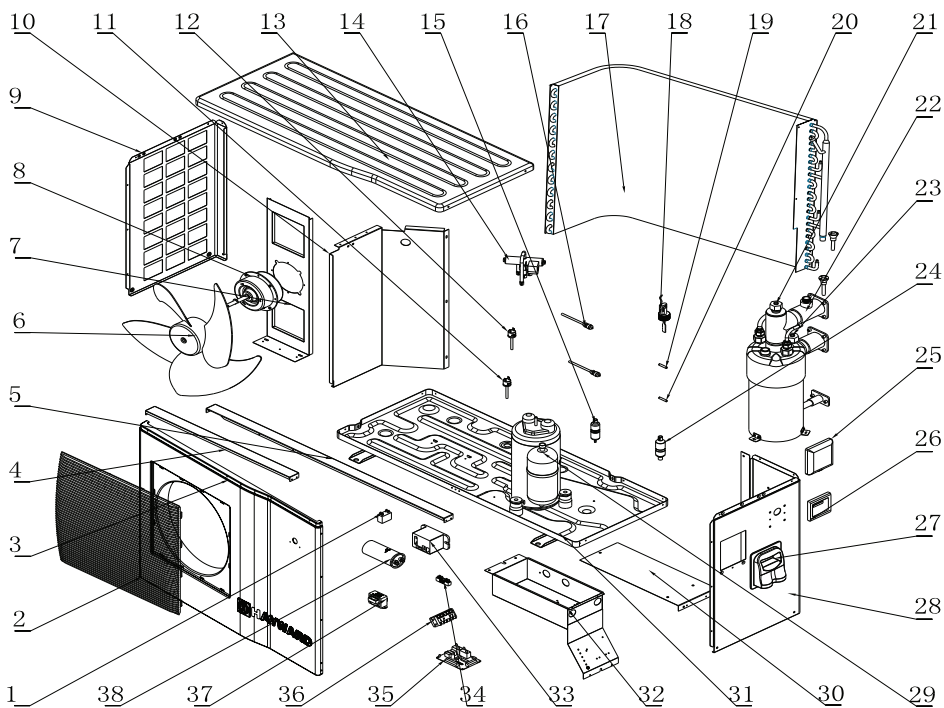



## 6. VEDLEGG (fortsettelse)

---

### ECP 08

Nr.	Ref.	Betegnelse	Nr.	Ref.	Betegnelse
1	HWX20003501	Vifte kondensator 3 $\mu$ F	21	HWX20003242	Temperatursonde
2	HWX35122213	Rist	22	HWX32081205	Kondensator Titanium/ PVC
3	HWX32012210240	Fremre ABS-panel	23	HWX20003242	Temperatursonde
4	HWX321221175	Fremre støttelist	24	HWX20041445	Filter( $\Phi$ 9.7- $\Phi$ 4.2)
5	HWX321221018	Bakre støttelist	25	HWX20002111	Kontroller-deksel
6	HWX35002701	Vifteblad	26	HWX950531188	Kontroller 7 segmenter
7	HWX321221174	Motorstøtte	27	HWX32009220054	Håndtak
8	HWX34043301	Viftemotor	28	HWX32012210238	Høyre panel
9	HWX32012210238	Venstre panel	29	HWX200011135	Kompressor
10	HWX321221173	Skillepanel	30	HWX321221019	Panel til elektrisk beskyttelse
11	HWX20013605	Høytrykkspressostat	31	HWX32012210237	Understell
12	HWX20003603	Lavtrykkspressostat	32	HWX321221176	Strømboks
13	HWX32012210241	Øvre ABS-panel	33	HWX20003619	Relé
14	HWX20011418	4-veis ventil	34	HWX20003909	Terminal 2 tilkoblinger
15	HWX20041446	Filter ( $\Phi$ 9.7 - $\Phi$ 3.4)	35	HWX950531145	Elektronisk kort PC1000
16	HWX200014153	Valve Shrader	36	HWX40003901	Terminal 5 tilkoblinger
17	HWX34061204	Fordamper	37	HWX200037006	Transformator 230V~/12V~
18	HWX200036005	Vannstrømningssensor	38	HWX20003510	Kompressorkondensator 60 $\mu$ F
19	HWX20003242	Temperatursonde	39	HWX20009909	Kapillær
20	HWX20003242	Temperatursonde			

## 6. VEDLEGG (fortsettelse)

---

### ECP 11

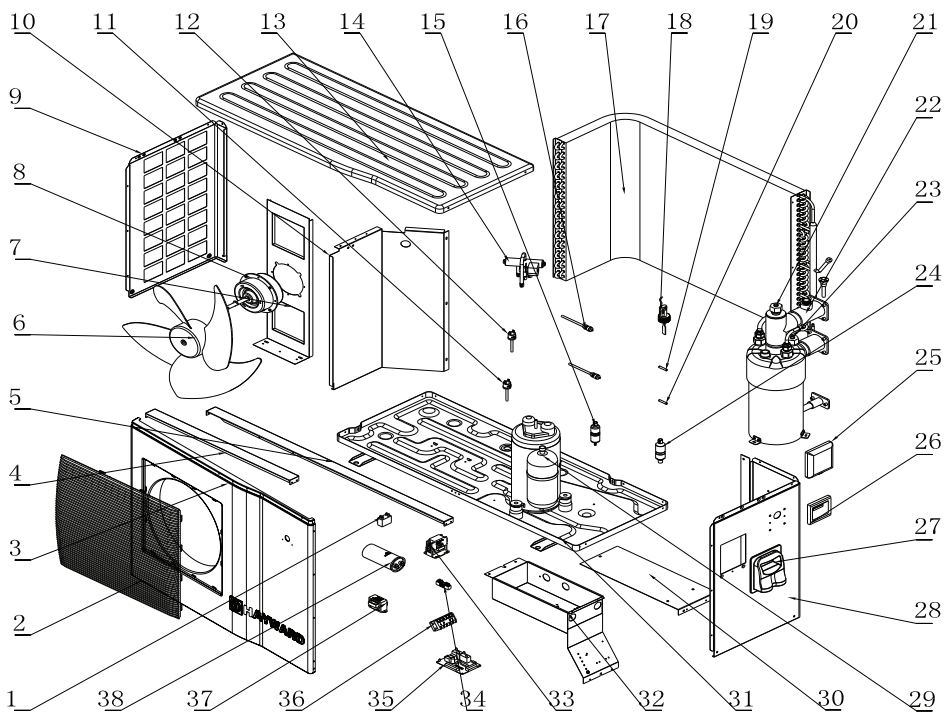

## 6. VEDLEGG (fortsettelse)

---

### ECP 11

Nr.	Ref.	Betegnelse	Nr.	Ref.	Betegnelse
1	HWX20003501	Viftekondensator 3 $\mu$ F	21	HWX20003242	Temperatursonde
2	HWX35122213	Rist	22	HWX32121209	Kondensator Titanium/ PVC
3	HWX32012210240	Fremre ABS-panel	23	HWX20003242	Temperatursonde
4	HWX321221175	Fremre støttelist	24	HWX20041445	Filter( $\Phi$ 9.7- $\Phi$ 4.2)
5	HWX321221018	Bakre støttelist	25	HWX20002111	Kontroller-deksel
6	HWX35002701	Vifteblad	26	HWX950531188	Kontroller 7 segmenter
7	HWX321221174	Motorstøtte	27	HWX32009220054	Håndtak
8	HWX34043301	Viftemotor	28	HWX32012210238	Høyre panel
9	HWX32012210238	Venstre panel	29	HWX200011134	Kompressor
10	HWX321221173	Skillepanel	30	HWX321221019	Panel til elektrisk beskyttelse
11	HWX20013605	Høytrykkspressostat	31	HWX32012210237	Understell
12	HWX20003603	Lavtrykkspressostat	32	HWX321221176	Strømboks
13	HWX32012210241	Øvre ABS-panel	33	HWX20003619	Relé
14	HWX20011418	4-veis ventil	34	HWX20003909	Terminal 2 tilkoplinger
15	HWX20041446	Filter ( $\Phi$ 9.7 - $\Phi$ 3.4)	35	HWX950531145	Elektronisk kort PC1000
16	HWX200014153	Valve Shrader	36	HWX40003901	Terminal 5 tilkoplinger
17	HWX321212002	Fordamper	37	HWX200037006	Transformator 230V~/12V~
18	HWX200036005	Vannstrømningssensor	38	HWX20003505	Kompressorkondensator 60 $\mu$ F
19	HWX20003242	Temperatursonde	39	HWX20009909	Kapillær
20	HWX20003242	Temperatursonde			

## 6. VEDLEGG (fortsettelse)

---

### ECP 13

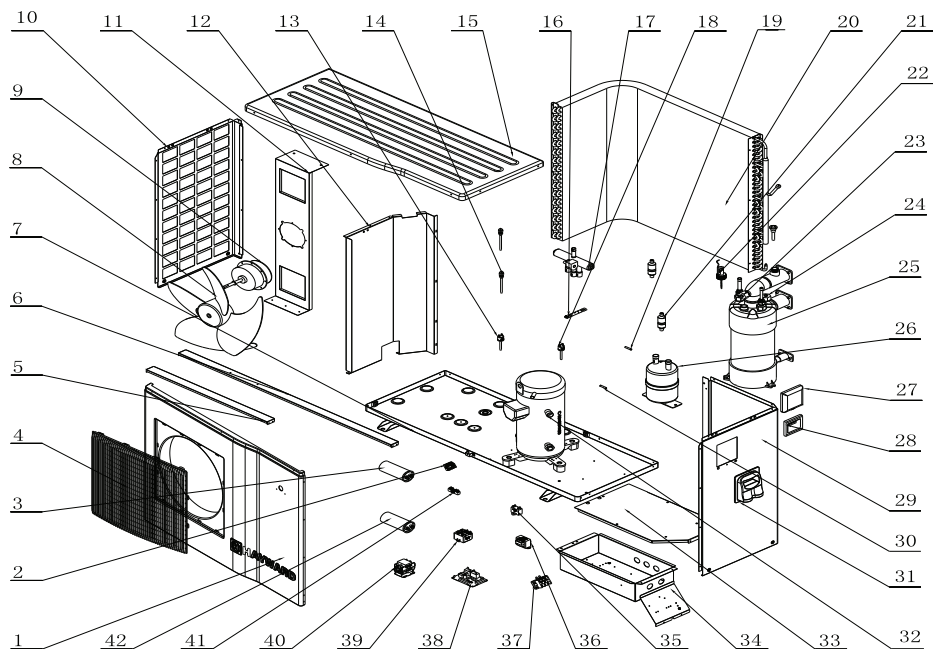

## 6. VEDLEGG (fortsettelse)

### ECP 13

Nr.	Ref.	Betegnelse	Nr.	Ref.	Betegnelse
1	HWX32009210196	Fremre ABS-panel	23	HWX20003242	Temperatursonde
2	HWX20003933	Terminal 3 tilkoplinger	24	HWX20003242	Temperatursonde
3	HWX20003524	Startkondensator CPS 98µF	25	HWX32091206	Kondensator Titanium/ PVC
4	HWX35122213	Rist	26	HWX35001401	Akkumulator
5	HWX320921015	Fremre støttelist	27	HWX20002111	Kontroller-deksel
6	HWX320921149	Bakre støttelist	28	HWX950531188	Kontroller 7 segmenter
7	HWX32009210193	Understell	29	HWX32009210194	Høyre panel
8	HWX35002701	Vifteblad	30	HWX20003242	Temperatursonde
9	HWX34043301	Viftemotor	31	HWX32009220054	Håndtak
10	HWX32009210195	Venstre panel	32	HWX20011170	Kompressor
11	HWX320921147	Motorstøtte	33	HWX320921152	Panel til elektrisk beskyttelse
12	HWX320921148	Skillepanel	34	HWX320921151	Strømboks
13	HWX20013605	Høytrykkspressostat	35	HWX20003501	Viftekondensator 3µF
14	HWX200014153	Valve Shrader	36	HWX200037006	Transformator 230V~/12V~
15	HWX32009210197	Øvre ABS-panel	37	HWX20003920	Terminal 3 tilkoplinger
16	HWX20001489	Strømningsbegrenser	38	HWX950531145	Elektronisk kort PC1000
17	HWX20011491	4-veis ventil	39	HWX20003676	Relé
18	HWX20003603	Lavtrykkspressostat	40	HWX200036007	Kompressorkontaktor
19	HWX20003242	Temperatursonde	41	HWX20003909	Terminal 2 tilkoplinger
20	HWX351212001	Fordamper	42	HWX20003510	Kompressorkondensator 60µF
21	HWX20041444	Filter (Ø9.7-Ø9.7)	43	HWX20009909	Kapillær
22	HWX200036005	Vannstrømningssensor			

## 6. VEDLEGG (fortsettelse)

---

### ECP 15

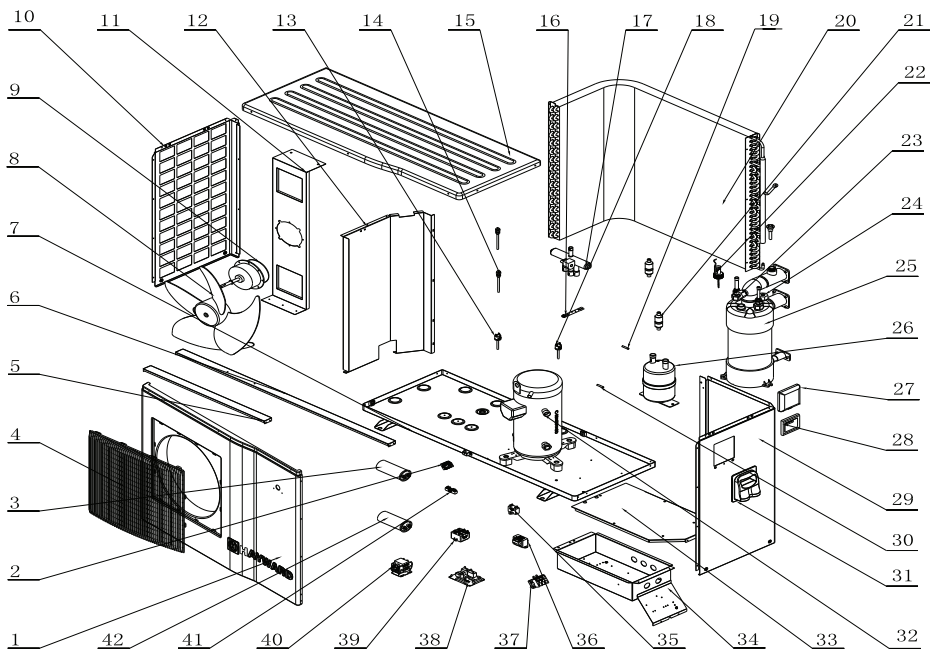

## 6. VEDLEGG (fortsettelse)

### ECP 15

Nr.	Ref.	Betegnelse	Nr.	Ref.	Betegnelse
1	HWX32009210196	Fremre ABS-panel	23	HWX20003242	Temperatursonde
2	HWX20003933	Terminal 3 tilkoplinger	24	HWX20003242	Temperatursonde
3	HWX20003524	Startkondensator CPS 98 $\mu$ F	25	HWX32091206	Kondensator Titanium/ PVC
4	HWX35122213	Rist	26	HWX35001401	Akkumulator
5	HWX320921015	Fremre støttelist	27	HWX20002111	Kontroller-deksel
6	HWX320921149	Bakre støttelist	28	HWX950531188	Kontroller 7 segmenter
7	HWX32009210193	Understell	29	HWX32009210194	Høyre panel
8	HWX35002701	Vifteblad	30	HWX20003242	Temperatursonde
9	HWX34043301	Viftemotor	31	HWX32009220054	Håndtak
10	HWX32009210195	Venstre panel	32	HWX20011169	Kompressor
11	HWX320921147	Motorstøtte	33	HWX320921152	Panel til elektrisk beskyttelse
12	HWX320921148	Skillepanel	34	HWX320921151	Strømboks
13	HWX20013605	Høytrykkspressostat	35	HWX20003501	Viftekondensator 3 $\mu$ F
14	HWX200014153	Valve Shrader	36	HWX200037006	Transformator 230V~/12V~
15	HWX32009210197	Øvre ABS-panel	37	HWX20003920	Terminal 3 tilkoplinger
16	HWX20001489	Strømningsbegrenser	38	HWX950531145	Elektronisk kort PC1000
17	HWX20011491	4-veis ventil	39	HWX20003676	Relé
18	HWX20003603	Lavtrykkspressostat	40	HWX200036007	Kompressorkontaktor
19	HWX20003242	Temperatursonde	41	HWX20003909	Terminal 2 tilkoplinger
20	HWX351212001	Fordamper	42	HWX20003510	Kompressorkondensator 60 $\mu$ F
21	HWX20041444	Filter (Ø9.7-Ø9.7)	43	HWX20009909	Kapillær
22	HWX200036005	Vannstrømningssensor			

## 6. VEDLEGG (fortsettelse)

### 6.4 Veiledning for feilsøking



*Enkelte operasjoner må utføres av en kvalifisert tekniker.*

Feil	Feilkoder	Beskrivelse	Løsning
Feil ved sonde ved vanninnløp	P01	Sensoren er åpen eller det er en kortslutning.	Sjekk eller skift ut sensoren.
Feil ved sonde ved vannutløp	P02	Sensoren er åpen eller det er en kortslutning.	Sjekk eller skift ut sensoren.
Feil ved sonde for utendørs temperatur	P04	Sensoren er åpen eller det er en kortslutning.	Sjekk eller skift ut sensoren.
Feil ved avrimingssonde	P05	Sensoren er åpen eller det er en kortslutning.	Sjekk eller skift ut sensoren.
Høytrykksbeskyttelse	E01	Trykket i kjølekreten er for høyt, vannsirkulasjonen er for lav, fordampere er tett eller luftsirkulasjonen for liten.	Sjekk høytrykkspressostaten og kjølekreten. Sjekk vann- eller luftsirkulasjonen. Sjekk at sirkulasjonskontrolleren fungerer som den skal. Sjekk åpningen av ventilene for vanninnløp-/utløp. Sjekk innstillingen av by-pass.
Lavtrykksbeskyttelse	E02	Trykket i kjølekreten er for lavt, vannsirkulasjonen er for lav eller fordampere er tett.	Sjekk lavtrykkspressostaten og trykket i kjølekreten for å vurdere om det er en lekkasje. Rengjør overflaten på fordampere. Sjekk hastigheten på vifterotasjonen. Sjekk den frie flyten av luft gjennom fordampere.
Feil ved sensoren for vannstrømming	E03	For lite vann eller kortsluttet eller defekt sensor	Sjekk vannstrømmen, sjekk filtreringspumpen og vannstrømmingssensoren for å se etter eventuelle defekter.
For stor temperaturforskjell mellom vannet i utløp og vannet i innløp	E06	Utilstrekkelig vannstrømningsvolum, for liten / for stor forskjell i vanntrykk.	Sjekk vannsirkulasjonen eller om systemet er tett.
Frostbeskyttelse Kjølemodus	E07	Vannutløpsmengden er for lav.	Sjekk vannstrømmen eller vannutløpets temperatursensor.
Kommunikasjonsfeil	E08	Feil ved LED-kontroller eller PCB-forbindelse.	Sjekk kabelkoplingene.
Første nivå av frostbeskyttelse	E19	Rom- eller vanninnløpstemperatur er for lav.	Stans varme pumpen og tømme kondensatoren. Frostfare
Første nivå av frostbeskyttelse	E29	Rom- eller vanninnløpstemperatur er enda lavere.	Stans varme pumpen og tømme kondensatoren. Frostfare



## 6. VEDLEGG (fortsettelse)

---

### 6.5 Garanti

#### GARANTIBETINGELSER

Alle HAYWARD-produkter er garantert mot fabrikkasjonsfeil og materialdefekter for en periode på to år fra kjøpsdatoen. Ved ethvert garantikrav må kvittering for kjøpet kunne forevises. Vi anbefaler på det sterkeste å ta godt vare på fakturaen.

HAYWARD-garantien er, etter valg fra HAYWARD, begrenset til reparasjon eller bytte av defekte produkter med det forbehold om at disse har vært i normal bruk i samsvar med instruksene som er nevnt i denne veiledningen, at det ikke er blitt foretatt endringer på produktet og at det kun er blitt brukt originale komponenter og deler fra HAYWARD. Skader som skyldes frost og kjemiske reaksjoner er ikke omfattet av denne garantien.

Alle andre kostnader (transport, arbeidskostnader...) er heller ikke omfattet av denne garantien. HAYWARD kan ikke holdes ansvarlig for verken direkte eller indirekte skader som skyldes installasjon, tilkopling eller feil drift av produktet.

For å kunne påberope seg garantien og be om reparasjon eller bytte av en artikkel, vennligst ta kontakt med forhandleren. Retur av materiell direkte til vår fabrikk vil ikke bli akseptert uten skriftlig godkjenning fra vår side av dette på forhånd.

Slitedeler omfattes ikke av garantien.

# Powerline

by **HAYWARD**<sup>TM</sup>

## LÄMPÖPUMPPU UIMA-ALTAALLE

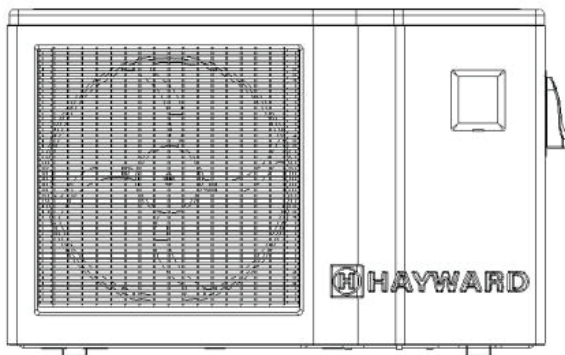

Asennus- ja ohjekirja

# SISÄLLYSLUETTELO

---

<b>1. Johdanto</b>	<b>1</b>
<hr/>	
<b>2. Tekniset ominaisuudet</b>	<b>2</b>
2.1 Lämpöpumpun tekniset tiedot	2
2.2 Käyttöympäristö	3
2.3 Mitat	4
<hr/>	
<b>3. Asennus ja liitännät</b>	<b>5</b>
3.1 Toimintakaavio	5
3.2 Lämpöpumppu	5
3.3 Vesiliitântä	6
3.4 Sähköliitântä	7
3.5 Ensimmäinen käynnistys	8
3.6 Veden virtaaman säätäminen	10
<hr/>	
<b>4. Ohjaustaulu</b>	<b>11</b>
4.1 Ohjaustaulun osat	11
4.2 Kellonajan asetus	13
4.3 Ajastimen (timer) asetus	13
4.4 Toimintatavan valinta: lämmitys tai jäähdytys	14
4.5 Ohjelämpötilan säätö ja näyttö	15
4.6 Ohjaustaulun lukitus ja käyttöönotto	15
<hr/>	
<b>5. Huolto ja talvisäilytys</b>	<b>16</b>
5.1 Huolto	16
5.2 Talvisäilytys	16
<hr/>	
<b>6. Liitteet</b>	<b>17</b>
6.1 Sähkökytkennät	17
6.2 Lämmitysliitännät	22
6.3 Räjätyskuvat	23
6.4 Vianetsintä	33
6.5 Takuu	34

Lue käyttöohje huolellisesti ja säilytä se myöhempää tarvetta varten.  
Anna käyttöohje uima-altaan omistajalle ja pyydä häntä pitämään se tallessa.

# 1. JOHDANTO

---

Kiitos, kun ostit Easy Temp uima-altaan lämpöpumpun. Tämä tuote on suunniteltu tiukkojen valmistusmääräysten mukaisesti vastaamaan vaadittua laatutasoa. Tämä käyttöohje sisältää kaikki laitteen asennukseen, toimintahäiriöiden poistamiseen ja huoltoon tarvittavat tiedot. Lue käyttöohje huolellisesti ennen kuin avaat laitteiston kotelon tai alat huoltaa laitteistoa. Laitevalmistaja ei vastaa henkilö- eikä laitevahingoista, jotka johtuvat virheistä laitteen asennuksessa, toimintahäiriöiden poistamisesta, tai tarpeettomasta huollosta. Noudata aina ehdottomasti tämän käyttöohjeen ohjeita! Laitteiston saa asentaa vain pätevä henkilö.

- Korjauksia saa tehdä vain pätevä henkilö.
- Sähköliitännät saa tehdä vain ammatti-ihminen asennusmaassa voimassa olevien määräysten mukaisesti ks. kohta 3.4.
- Huolto ja muut toimet on suoritettava tässä käyttöohjeessa suositelluin välein ja neuvotuissa tilanteissa.
- Käytä ainoastaan alkuperäisiä varaosia.
- Jos suosituksia ei ole noudatettu, takuu raukeaa.
- Tämä lämpöpumppu on tarkoitettu uima-altaan veden lämmitykseen ja sen pitämiseen vakiolämpöisenä. Sitä ei saa käyttää mihinkään muuhun tarkoitukseen.

Säilytä käyttöohje myöhempää tarvetta varten.

Lapsia ja vajaakuntoisia koskevat varoitukset:

Laitetta eivät saa käyttää henkilöt (varsinkaan lapset), joiden fyysiset, älylliset tai aistitoiminnot ovat heikentyneet, eivätkä henkilöt, joilla ei ole kokemusta tai tietoa sen käytöstä, ellei heitä valvota tai ellei heidän turvallisuudestaan vastaava henkilö ole ohjeistanut heitä laitteen käyttöä varten.

Tuote sisältää fluorattuja kasviuonekaasuja, joiden käyttöä valvotaan Kioton ilmastopöytäkirjalla

Kylmäainetyyppi: R410A

Arvo GWP<sup>(1)</sup>: 1975

Eurooppalainen tai paikallinen lainsäädäntö voi edellyttää säännöllisiä tarkistuksia kylmäainevuotojen varalta. Kysy lisätietoja jälleenmyyjältäsi.

---

(1) Laitteiston ylikuumenemisvaara

## 2. TEKNISET OMINAISUUDET

### 2.1 Lämpöpumpun tekniset tiedot

Malli	EASY TWMP	ECP 06	ECP 08	ECP 11	ECP 13	ECP 15
Lämmitysteho*	kW BTU/h	5,5 18785	8 27322	11 37566	13,5 46105	15 51228
Ottoteho	kW	1,17	1,8	2,43	3	3,13
Käyttövirta *	A	5,19	7,91	11,81	14,5	16
Käyttöjännite	V Ph/Hz	230 V ~ 1/50 Hz	230 V ~ 1/50 Hz	230 V ~ 1/50 Hz	230 V ~ 1/50 Hz	230 V ~ 1/50 Hz
Sulake aM	A	8 aM	10 aM	16 aM	20 aM	20 aM
D-käyräkatkaisin	A	8 D	10 D	16 D	20 D	20 D
Kompressorien määrä		1	1	1	1	1
Kompressorityyppi		Kiertomäntä	Kiertomäntä	Kiertomäntä	Kierukka	Kierukka
Tuulettimien määrä		1	1	1	1	1
Tuulettimen teho	W	50	120	120	120	120
Tuulettimen pyörimisnopeus	kierr./min	770	850	850	850	850
Tuulettimen puhallussuunta		Vaakasuora	Vaakasuora	Vaakasuora	Vaakasuora	Vaakasuora
Äänenpainetaso (1 metrin etäisyydellä)	dB(A)	47	51	54	56	56
Vesiliitäntä	mm	50	50	50	50	50
Veden virtaama	m <sup>3</sup> /h	2,3	3,0	4,5	5,3	6,6
Veden painehäviö (enint.)	kPa	5,4	8,9	19,2	5,2	39,9
Laitteiston nettomitat (p//k)	mm	895/375/545	1035/415/650	1035/415/650	1136/440/870	1136/440/870
Pakkauksen mitat (p//k)	mm	970/430/710	1120/480/810	1180/480/810	1230/510/1020	1230/510/1020
Nettopaino / koko pakkauksen paino	kg	45/56	54/68	60/74	95/115	117/128



\* Arvot voivat vaihdella +/- 5 % seuraavissa oloissa: Ulkolämpötila = 24 °C/ suhteellinen ilmankosteus=62 %/Altaan veden lämpötila = 27 °C

## 2. TEKNISET OMINAISUUDET (jatkoa)

---

### 2.2 Käyttöympäristö

Käytä lämpöpumppua vain ympäristöissä, joiden lämpötila ja suhteellinen ilmankosteus vastaavat seuraavan taulukon arvoja, niin laitteisto toimii varmasti ja tehokkaasti.

	Lämmitystoiminto 	Jäähdytystoiminto 
Ulkolämpötila	+2°C ~ +35°C	+7°C ~ +43°C
Veden lämpötila	+12°C ~ +40°C	+8°C ~ +40°C
Suhteellinen ilmankosteus	< 80%	< 80%
Ohjelämpötila	+15°C ~ +40°C	+8°C ~ +35°C



***Jos lämpötila tai ilmankosteus ei vastaa annettuja arvoja, suojalaitteet voivat kytkeytyä päälle, jolloin lämpöpumppu lakkaa toimimasta.***

## 2. TEKNISET OMINAISUUDET (jatkoa)

### 2.3 Mitat

Mallit: ECP06 / ECP08 / ECP11 / ECP13 / ECP15

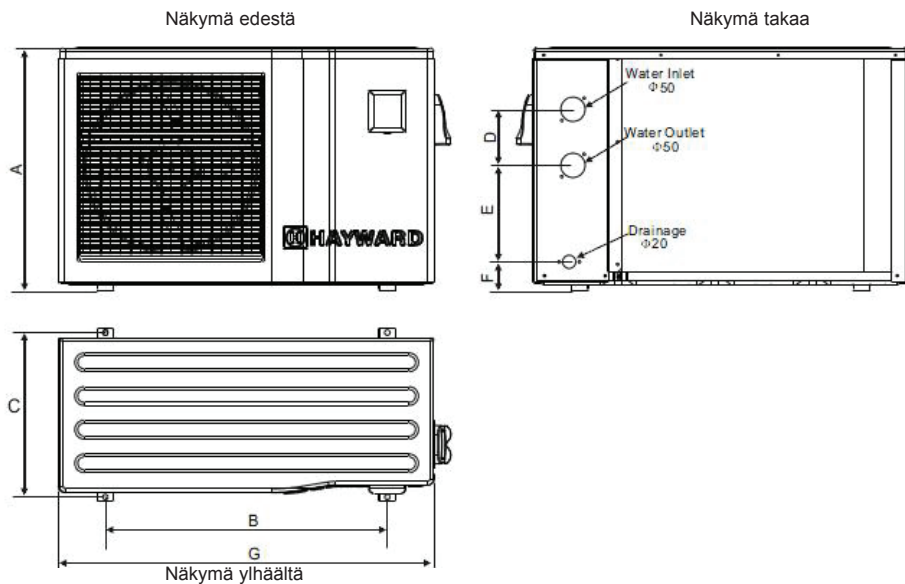

Yksikkö: mm

Malli \ Mitta	ECP06	ECP08 ECP11	ECP13 ECP15
<b>A</b>	540	648	866
<b>B</b>	571	755	840
<b>C</b>	400	440	470
<b>D</b>	140	150	150
<b>E</b>	258	258	330
<b>F</b>	66	77	80
<b>G</b>	860	1004	1114

## 3. ASENNUS JA LIITÄNNÄT

### 3.1 Toimintakaavio

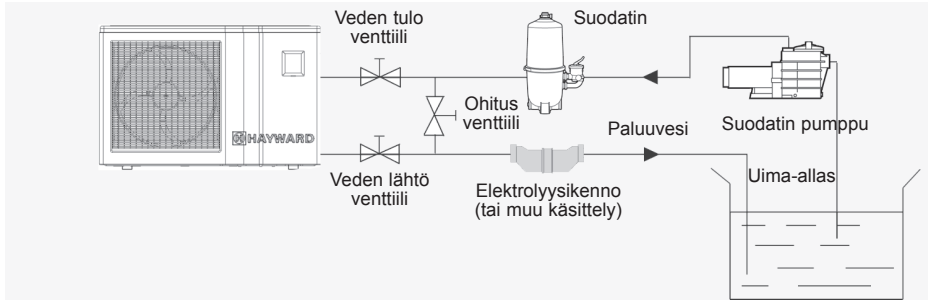

Huomaa: Lämpöpumppu toimitetaan ilman veden käsittely- tai suodatuslaitteita. Asentajan on hankittava kaaviossa esitetyt osat.

### 3.2 Lämpöpumppu



**Sijoita lämpöpumppu ulkotiloihin, älä suljettuihin teknisiin tiloihin.**

**Sijoita pumppu suojaan auringolta ja noudata alla annettuja vähimmäisetäisyyksiä, niin ilmankierto ei häiriinny.**

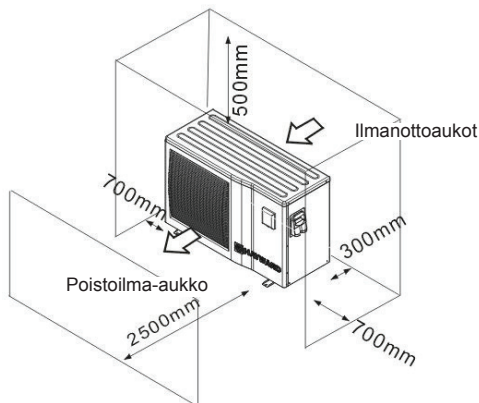



### 3. ASENNUS JA LIITÄNNÄT (jatkoa)

---



**Asenna lämpöpumppu mieluiten omalle betonilaatalleen tai sitä varten rakennetulle kiinnitysalustalle ja asenna pumpun mukana toimitetut puslat pumpun alle (ruuvit ja aluslaatat eivät kuulu toimitukseen).**

**Asenna lämpöpumppu enintään 15 m etäisyydelle uima-altaasta.**

**Vesiputkistojen kokonaispituus saa olla enintään 30 metriä.**

**Eristä sekä maan pinnalle jäävät että maan sisään upotettavat vesiputket.**

#### 3.3 Vesiliitäntä

Lämpöpumpussa on kaksi liitäntää, joiden halkaisija on 50 mm. Käytä vesiliitäntöihin Ø 50 mm PVC-putkea. Liitä suodatinjärjestelmästä tuleva tulovesiputki lämpöpumpun tuloliitäntään ja uima-altaaseen menevä lähtevän veden putki lämpöpumpun lähtöliitäntään (ks. kaaviota alla).

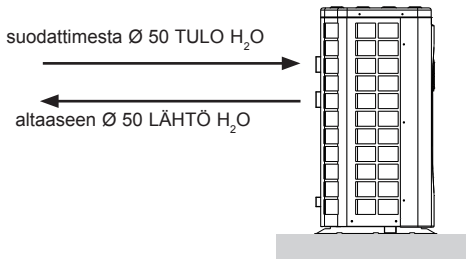

Asenna ohitusventtiili lämpöpumpun veden tulo- ja lähtöliitäntöjen väliin.



**Jos käytät automaattista ohjauslaitetta tai elektrolyysikennoa, asenna se ehdottomasti vasta lämpöpumpun jälkeen, muuten lämpöpumpun titaanilauhduksen kemikaalipitoisuus voi nousta liikaa.**



**Asenna laitteen mukana toimitetut ohitusventtiili ja jatkoliittimet laitteiston tulo- ja lähtöliitäntöjen korkeudelle, niin talvityhjennys yksinkertaistuu ja venttiiliin pääsee helpommin käsiksi ja se on helppo purkaa huoltoa varten.**

## 3. ASENNUS JA LIITÄNNÄT (jatkoa)

### 3.4 Sähköliitäntä



**Laitteiston sähköliitäntöjen ja johdotusten on oltava paikallisten voimassa olevien määräysten mukaiset.**

F	NF C15-100	GB	BS7671:1992
D	DIN VDE 0100-702	EW	EVHS-HD 384-7-702
A	ÖVE 8001-4-702	H	MSZ 2364-702/1994/MSZ 10-553 1/1990
E	UNE 20460-7-702 1993, RECBT ITC-BT-31 2002	M	MSA HD 384-7-702.S2
IRL	Wiring Rules + IS HD 384-7-702	PL	PN-IEC 60364-7-702:1999
I	CEI 64-8/7	CZ	CSN 33 2000 7-702
LUX	384-7.702 S2	SK	STN 33 2000-7-702
NL	NEN 1010-7-702	SLO	SIST HD 384-7-702.S2
P	RSIUEE	TR	TS IEC 60364-7-702



**Varmista että käytettävän verkkovirran jännite ja taajuus vastaavat laitteen teknisissä tiedoissa mainittuja ja että käytettävän virtapiirin (sulakkeen) teho liittää kaikille piiriin liitetyille laitteille.**

**ECP 06 230 V~ +/- 10 % 50 HZ 1 vaihe**

**ECP 08 230 V~ +/- 10 % 50 HZ 1 vaihe**

**ECP 11 230 V~ +/- 10 % 50 HZ 1 vaihe**

**ECP 13 230 V~ +/- 10 % 50 HZ 1 vaihe**

**ECP 15 230 V~ +/- 10 % 50 HZ 1 vaihe**

**Noudata liitteen kytkentäkaaviota.**

**Liitäntärasia on laitteiston oikealla puolella. Siinä on kolme tuloliitäntää ja kaksi suodatinpumpun ohjauksesta toimivaa lähtöliitäntää (Takaisinkytkentä).**

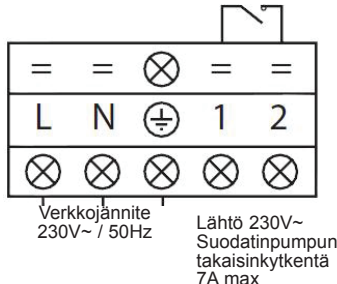

### 3. ASENNUS JA LIITÄNNÄT (jatkoa)

---



**Laitteiston virtajohto pitää varustaa asianmukaisella moottoripiirin suojasulakkeella (aM) tai D-käyrä johdonsuojakatkaisimella. Liitäntä on lisäksi varustettava 30mA vikavirtasuojakytkimellä (ks. seuraava taulukko).**

Mallit		ECP 06	ECP 08	ECP 11	ECP 13	ECP 15
Käyttöjännite	V/Ph/ Hz	230 V~ 1/50 Hz	230 V~ 1/50 Hz	230 V~ 1/50 Hz	230 V~ 1/50 Hz	230 V~ 1/50 Hz
Sulake aM	A	8 aM	10 aM	16 aM	20 aM	20 aM
ohdonsuojakatkaisin D-käyrä	A	8 D	10 D	16 D	20 D	20 D



**Muista ehdottomasti katkaista virta sulaketaulun pääkatkaisimesta ennen, kuin avaat laitteiston liitäntärasian.**

#### 3.5 Ensimmäinen käynnistys

Käynnistys. Kun asennus on valmis, toimi seuraavasti:

- 1) Pyöritä tuuletinta käsin ja varmista, että se pääsee pyörimään vapaasti ja että potkuri on kiinnitetty oikein moottorin varteen.
- 2) Varmista, että laitteisto on liitetty oikein sähköverkkoon (ks. liitteen kytkentäkaavio).
- 3) Kytke suodatinpumppu päälle.
- 4) Varmista, että kaikki vesiventtiilit ovat auki ja että laitteistoon virtaa vettä, ennen kuin kytket lämmitys- tai jäähdystoiminnon päälle.
- 5) Varmista, että kondenssiveden tyhjennysputki on liitetty oikein ja ettei se ole tukossa.
- 6) Kytke laitteistoon virta ja paina sitten ohjaustaulun  käynnistys-/pysäytyspainiketta.
- 7) Kun laite on kytkettyyn päälle, varmista, ettei näyttöön ole ilmestynyt mitään virheilmoituksia (ks. Vianetsintä)

### 3. ASENUS JA LIITÄNNÄT (jatkoa)

---

- 8) Säädä veden virtaama ohitusventtiilin avulla (ks. kohdat 3.6 ja 2.1) mallikohtaisesti siten, että tulevan ja lähtevän veden lämpötilaero on 2 °C.
- 9) Kun laite on käynyt joitain minutteja, tarkista, että sen poistoilma on kylmää (5–10 °).
- 10) Anna laitteen käydä ja kytke suodatinpumppu pois päältä. Laitteiston kuuluu pysähtyä automaattisesti ja näyttöön tulla virhekoodi E03.
- 11) Anna laitteiston ja uima-altaan pumpun käydä vuorokauden ajan, tai kunnes haluttu veden lämpötila on saavutettu. Kun tulevan veden lämpötila saavuttaa ohjearvon, laitteisto pysähtyy. Se käynnistyy automaattisesti uudelleen (niin kauan kuin uima-altaan pumppu käy), jos uima-altaan veden lämpötila on laskenut vähintään 0,5 °C alle ohjelämpötilan.

**Virtauksen valvontalaite** – Laitteistossa on valvontalaite, joka käynnistää lämpöpumpun, kun uima-altaan suodatinpumppu on käytössä ja pysäyttää sen, kun suodatinpumppu on pois käytöstä. Ellei järjestelmään tule vettä, laitteen näyttöön tulee virhekoodi E03 (Ks. kohta 6.4).

**Käynnistysviive** – laitteisto käynnistyy 3 minuutin viiveellä. Viiveen tarkoitus on suojata ohjauspiirin osia, ehkäistä uudelleenkäynnistymisen aiheuttamaa epästabiilisuutta sekä kytkinhäiriöitä. Viiveen vuoksi laitteisto käynnistyy automaattisesti uudelleen noin kolmen minuutin kuluttua ohjauspiirin virran katkeamisesta. Lyhytkin virtakatkos laukaisee käynnistyneen viiveen.

## 3. ASENNUS JA LIITÄNNÄT (jatkoa)

### 3.6 Veden virtaaman säätäminen

Kun lämpöpumppu on toiminnassa ja tulevan ja lähtevän veden venttiilit auki, säädä ohitusventtiiliä siten, että tulevan ja lähtevän veden lämpötilaero on 2 °C (ks. kohdan 3.1 toimintakaavio). Voit tarkistaa säädöt ohjaustaulun tulo- (T02) ja lähtölämpötilanäytöistä (T03) seuraavalla tavalla.

Säädä sitten ohitusventtiilin avulla T03:n ja T02:n lämpötilaeroksi 2 °C (T03-T02 =  $\Delta T$  = 2).

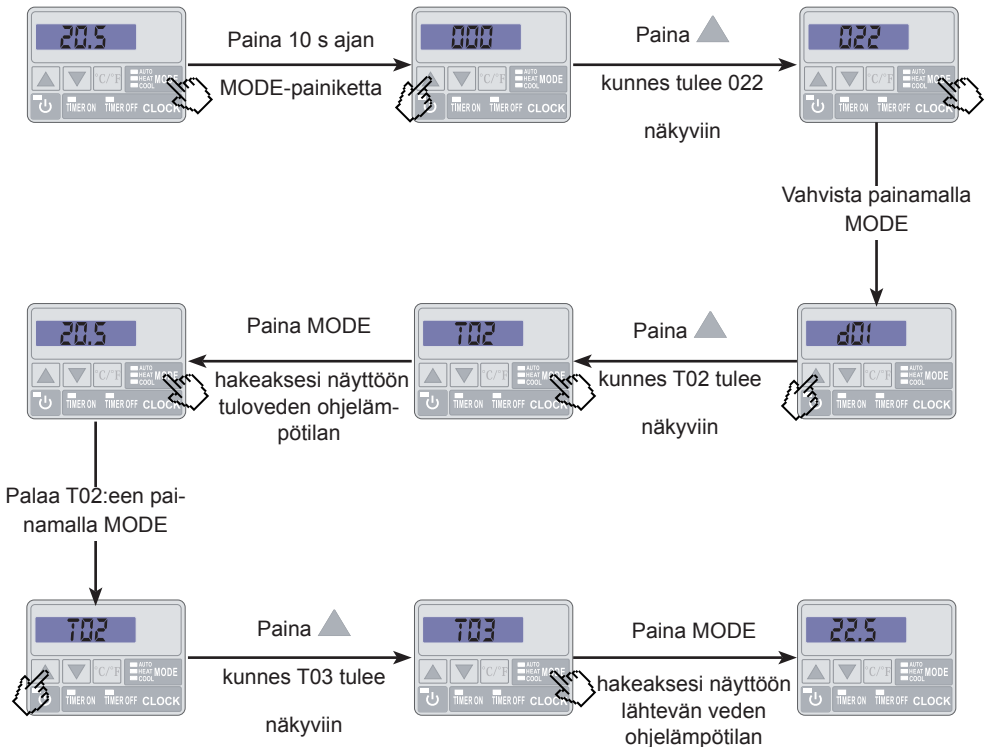

Poistu valikosta painamalla kaksi kertaa 

Huomaa: Ohitusventtiilin vääntäminen auki pienentää virtaamaa, jolloin  $\Delta T$  kasvaa.

Ohitusventtiilin vääntäminen kiinni suurentaa virtaamaa, jolloin  $\Delta T$  pienenee.

## 4. OHJAUSTAULU

---

### 4.1 Ohjaustaulun osat

Lämpöpumpussa on elektroninen, valmiiksi liitetty ohjaustaulu, ja sen tehdasasetuksena on lämmitystoiminto.

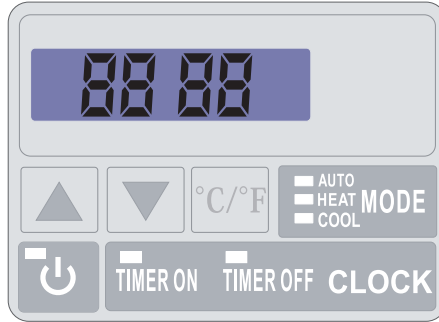

#### Selitykset

-  **COOL** Jäähdytystoiminnon symboli
-  **HEAT** Lämmitystoiminnon symboli
-  **AUTO** Automaattitila
-  **CLOCK** Kellonajan ja ajastimen asetus
-  **MODE** Toiminnon valinta ja säätö
-  **Power** Käynnistys-/pysäytys- ja paluu/vahvistapainike
-  **Down arrow** Pienennä arvoa -painike
-  **Up arrow** Suurena arvoa -painike
-  **TIMER ON** Käynnistysajan asetus
-  **TIMER OFF** Pysäytysajan asetus

## 4. OHJAUSTAULU (jatkoa)

---

### OFF-tila

Kun lämpöpumppu on valmiustilassa (OFF-tila) kellonaika ja toiminto näkyvät näytössä.

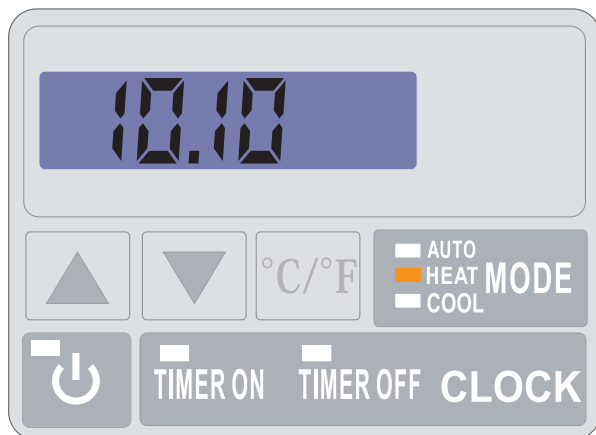

### ON-tila



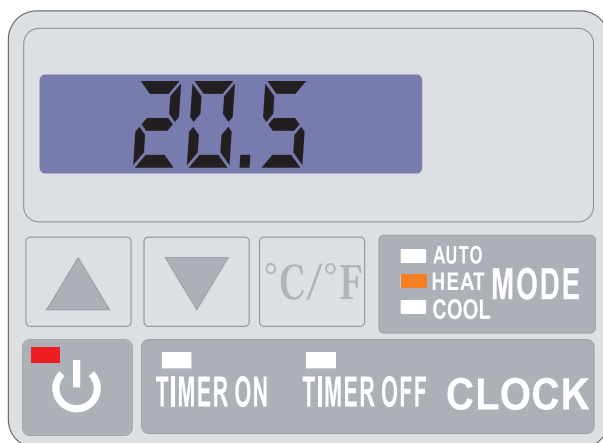

Kun lämpöpumppu on toiminnassa tai kun teet parhaillaan asetuksia (ON-tila), käynnistuspainikkeen punainen merkkivalo palaa ja näytössä näkyy tulevan veden lämpötila.



## 4. OHJAUSTAULU (jatkoa)

---

### 4.2 Kellonajan asetus





Kelloa voi säätää sekä ON- että OFF-tilassa. Paina CLOCK, näyttö alkaa vilkkua, paina sitten CLOCK, niin tuntilukema alkaa vilkkua. Aseta tunnit nuolipainikkeella  tai  paina vielä kerran CLOCK, jolloin minuutilukema alkaa vilkkua. Aseta minuutit nuolipainikkeella  tai . Vahvasta painamalla CLOCK. Näyttö palaa aiempaan tilaansa.

Huomaa: Vahvasta tekemäsi asetukset painamalla CLOCK. Ellet paina mitään painiketta viiteen sekuntiin, ne tallentuvat automaattisesti.

### 4.3 Ajastintoiminnon (timer) asetus

Tarvitset tätä toimintoa, jos haluat käyttää lämpöpumppua lyhyemmän aikaa kuin suodatinpumpun kelloon on määritely. Voit näin ajastaa lämpöpumpun käynnistymään ja kytkeytymään pois päältä haluamaasi aikaan tai kytkeä lämpöpumpun pois päätä tietyksi ajaksi (esimerkiksi yöksi).





#### Käynnistymisajan ohjelmointi (Timer ON) / Käynnistys

- 1) Paina Timer ON, niin kellonaika alkaa vilkkua.
- 2) Paina Timer ON ja aseta aika painamalla  .
- 3) Paina Timer ON ja aseta minuutit painamalla  .

Tallenna asetukset painamalla Timer ON. Ellet paina mitään painiketta viiteen sekuntiin, ne tallentuvat automaattisesti.

Vihreä merkkivalo syttyy merkiksi siitä, että ajastin on käytössä.

#### Pysähtymisajan ohjelmointi (Timer OFF) / Pysäytys

- 1) Paina Timer OFF, niin kellonaika alkaa vilkkua.
- 2) Paina Timer OFF ja aseta tunnit painamalla  .
- 3) Paina Timer OFF ja aseta minuutit painamalla  .

Tallenna asetukset painamalla Timer OFF. Ellet paina mitään painiketta viiteen sekuntiin, ne tallentuvat automaattisesti.



Punainen merkkivalo syttyy merkiksi siitä, että ajastin on käytössä.



## 4. OHJAUSTAULU (jatkoa)

---

### Käynnistymis- ja pysähtymisaikojen nollaus (Timer ON ja OFF)

- 1) Paina Timer ON. Se alkaa vilkkua.
- 2) Paina  niin ajastin nollaantuu.
- 3) Paina Timer OFF. Se alkaa vilkkua.
- 4) Paina  niin ajastin nollaantuu.

### 4.4 Toimintatavan valinta: lämmitys, jäähdytys tai automaattinen.

#### OFF- tai ON-tila

Siirry toiminnosta toiseen painamalla MODE-painiketta: jäähdytystoiminto (vihreä merkkivalo), lämmitystoiminto (oranssi merkkivalo) ja automaattitila (punainen merkkivalo).

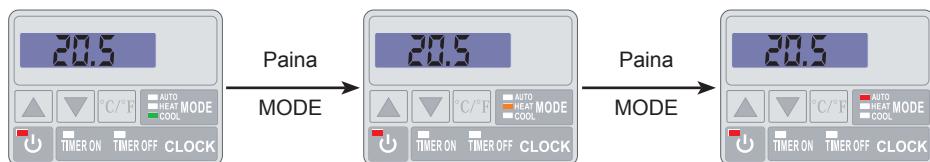





## 4. OHJAUSTAULU (jatkoa)

---

### 4.5 Ohjelämpötilan säätö ja näyttö (haluttu veden lämpötila)

#### OFF- tai ON-tilassa

Paina painikkeita  tai  määrittääksesi haluamasi ohjelämpötilan. Voit säätää lämpötilaa 0,5 °C:een tarkkuudella.

Huomaa: Kun laite on käynnissä tai valmiustilassa, paina  tai 



**Älä koskaan valitse yli 30 °C:een lämpötilaa, etteivät tiivisteet heikkene.**

, niin näet valitun ohjelämpötilan ja voit muuttaa sitä.

### 4.6 Kosketusnäytön lukitus ja käyttöönotto

Paina käynnistys-/pysäytyspainiketta  5 sekunnin ajan, kunnes laitteesta kuuluu piip-ääni. Hipaisukytkimet menevät pois käytöstä.

Avaa lukitus painamalla painiketta  5 sekunnin ajan, kunnes laitteesta kuuluu piip-ääni.

Hipaisukytkimet ovat taas käytössä.

## 5. HUOLTO JA TALVISÄILYTYS

---

### 5.1 Huolto

Suorita nämä huoltotoimet kerran vuodessa, niin lämpöpumppu toimii moitteettomasti ja kestää käytössä pitkään.

- Puhdista höyrystin pehmeällä harjalla, paineilmalla tai vesisuihkulla (**Älä koskaan käytä painepesuria** ).
- Varmista, että kondenssivesi pääsee valumaan pois esteettä.
- Tarkista vesi- ja sähköliitännöiden kireys.
- Tarkista vesiliitännöiden tiiviys.



***Kytke lämpöpumppu irti sähköverkosta aina ennen huoltotoimien aloittamista. Huoltotoimia saa tehdä ainoastaan kylmäaineiden käsittelyyn perehtynyt ammatti-ihminen.***

### 5.2 Talvisäilytys

- Kytke lämpöpumppu pois päältä.
- Irrota lämpöpumppu sähköverkosta.
- Valuta kondenssivesi ulos, jottei se pääse jäätymään ja hajottamaan laitetta. (Jäätymisvaara.)
- Sulje ohitusventtiili ja irrota tulevan ja lähtevän veden putket pumpun liitännöistä.
- Puhalla loppu vesi pois laitteistosta paineilmapistoolilla.
- Tuki lämpöpumpun veden tulo- ja lähtöliitännät, ettei sen sisään pääse roskaa.
- Suojaa lämpöpumppu talvihupulla (ei kuulu toimitukseen).



***Virheellisestä talvisäilytyksestä johtuvat vahingot eivät kuulu takuun piiriin.***

## 6. LIITTEET

### 6.1 Sähkökytkennät

ECP 06

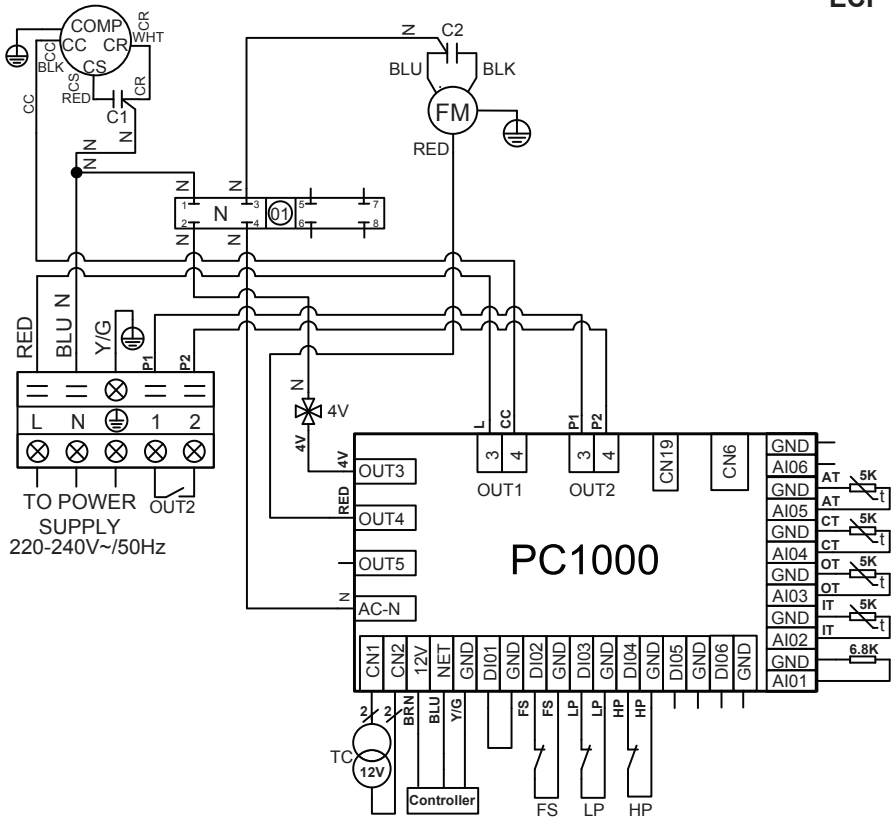

**HUOMAUTUS:**  
 AT: ILMAN LÄMPÖTILA-ANTURI  
 COMP: KOMPRESSORI  
 CT: HÖYRYSTIMEN LÄMPÖTILA-ANTURI  
 FM: TUULETTIMEN MOOTTORI  
 FS: VESIAANTURI  
 HP: YLIPAINEPRESSOSTAATTI  
 IT: TULOVEDEN LÄMPÖTILA-ANTURI  
 LP: ALIPAINEPRESSOSTAATTI

OT: LÄHTEVÄN VEDEN LÄMPÖTILA-ANTURI  
 TC: MUUNNIN 230V~12V~  
 4V: NELITIEVENTTIILI  
 C1: KOMPRESSORIN KONDENSAATTORI  
 C2: TUULETTIMEN KONDENSAATTORI  
 OUT2 : СВОБОДНЫЙ КОНТАКТ С МАКСИМАЛЬНЫМ  
 ПОТЕНЦИАЛОМ 7А

## 6. LIITTEET (jatkoa)

ECP 08

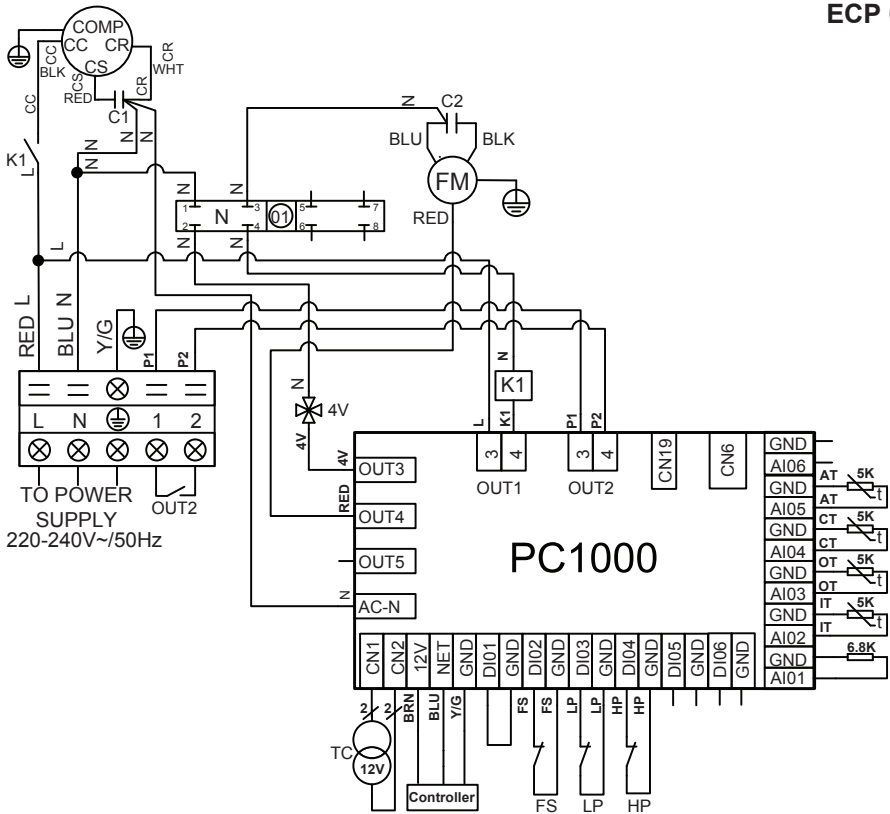

### HUOMAUTUS:

AT: ILMAN LÄMPÖTILA-ANTURI  
 COMP: KOMPRESSORI  
 CT: HÖYRYSTIMEN LÄMPÖTILA-ANTURI  
 FM: TUULETTIMEN MOOTTORI  
 FS: VESIAANTURI  
 HP: YLIPAINEPRESSOSTAATTI  
 IT: TULOVEDEN LÄMPÖTILA-ANTURI

LP: ALIPAINEPRESSOSTAATTI  
 OT: LÄHTEVÄN VEDEN LÄMPÖTILA-ANTURI  
 TC: MUUNNIN 230V~/12V~  
 4V: NELITIEVENTTIILI  
 K1: KOMPRESSORIN RELE  
 C1: KOMPRESSORIN KONDENSAATTORI  
 C2: TUULETTIMEN KONDENSAATTORI  
 OUT2 : СВОБОДНЫЙ КОНТАКТ С МАКСИМАЛЬНЫМ ПОТЕНЦИАЛОМ 7А

## 6. LIITTEET (jatkoa)

ECP 11

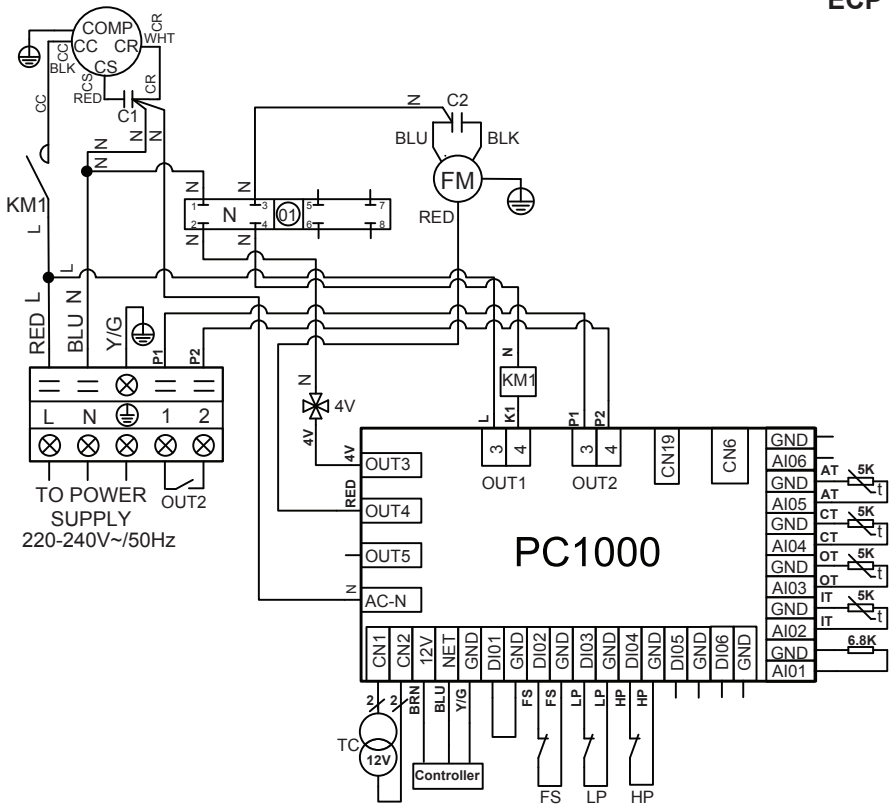

### HUOMAUTUS:

AT: ILMAN LÄMPÖTILA-ANTURI  
 COMP: KOMPRESSORI  
 CT: HÖYRYSTIMEN LÄMPÖTILA-ANTURI  
 FM: TUULETTIMEN MOOTTORI  
 FS: VESIANTURI  
 HP: YLIPAINEPRESSOSTAATTI  
 IT: TULOVEDEN LÄMPÖTILA-ANTURI

LP: ALIPAINEPRESSOSTAATTI  
 OT: LÄHTEVÄN VEDEN LÄMPÖTILA-ANTURI  
 TC: MUUNNIN 230V~/12V~  
 4V: NELITIEVENTTILII  
 KM1: KOMPRESSORIN ELEKTRONINEN KYTKIN  
 C1: KOMPRESSORIN KONDENSAATTORI  
 C2: TUULETTIMEN KONDENSAATTORI  
 OUT2 : СВОБОДНЫЙ КОНТАКТ С МАКСИМАЛЬНЫМ ПОТЕНЦИАЛОМ 7А

## 6. LIITTEET (jatkoa)

ECP 13

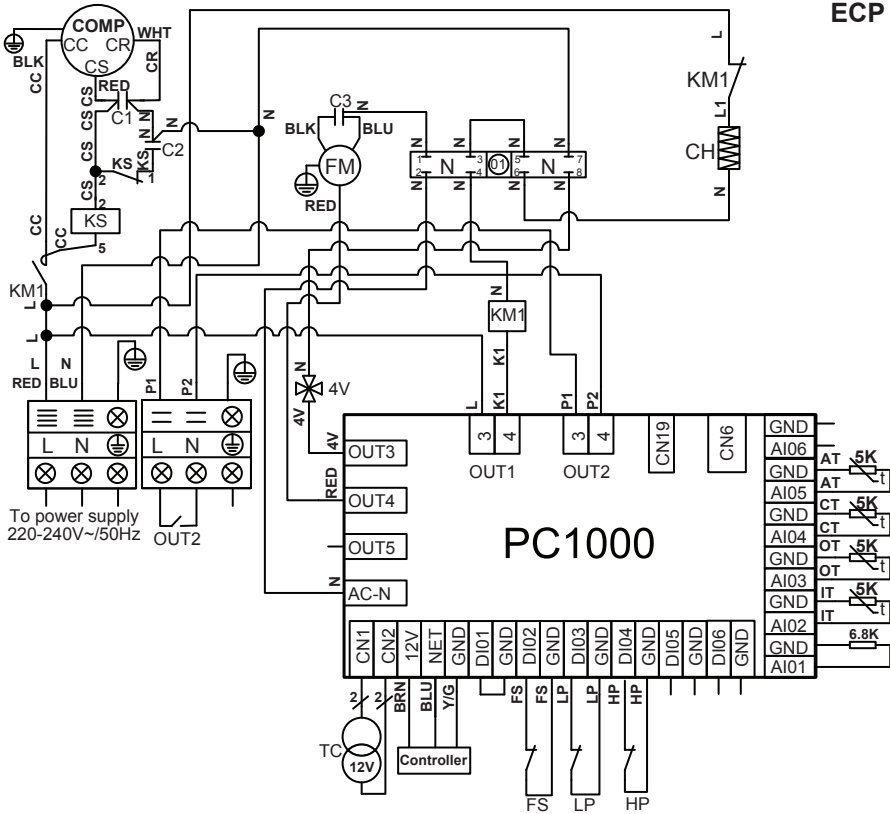

### HUOMAUTUS:

AT: ILMAN LÄMPÖTILA-ANTURI  
 COMP: KOMPRESSORI  
 CH: VAIPAN VASTUS  
 CT: HÖYRYSTIMEN LÄMPÖTILA-ANTURI  
 FM: TUULETTIMEN MOOTTORI  
 FS: VESIANTURI  
 HP: YLIPAINEPRESSOSTAATTI  
 IT: TULOVEDEN LÄMPÖTILA-ANTURI

KS: KOMPRESSORIN KÄYNNISTYKSEN RELEEN KÄÄMI  
 LP: ALIPAINEPRESSOSTAATTI  
 OT: LÄHTEVÄN VEDEN LÄMPÖTILA-ANTURI  
 TC: MUUNNIN 230V~12V~  
 4V: NELITIEVENTTIILI  
 KM1: KOMPRESSORIN KYTKIN  
 C1: JATKUVAN KÄYTÖN KONDENSAATTORI  
 C2: KÄYNNISTYKSEN KONDENSAATTORI  
 OUT2 : СВОБОДНЫЙ КОНТАКТ С МАКСИМАЛЬНЫМ ПОТЕНЦИАЛОМ 7А

# 6. LIITTEET (jatkoa)

ECP 15

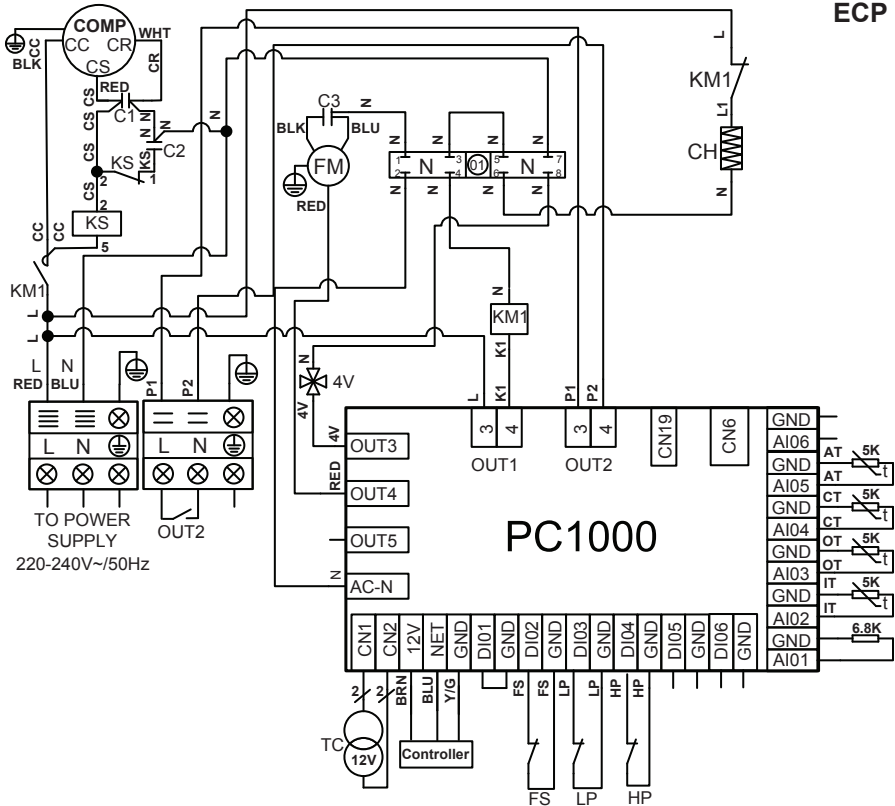

**HUOMAUTUS:**  
 AT: ILMAN LÄMPÖTILA-ANTURI  
 COMP: KOMPRESSORI  
 CH: VAIPAN VASTUS  
 CT: HÖYRYSTIMEN LÄMPÖTILA-ANTURI  
 FM: TUULETTIMEN MOOTTORI  
 FS: VESIAANTURI  
 HP: YLIPAINEPRESSOSTAATTI  
 IT: TULOVEDEN LÄMPÖTILA-ANTURI

KS: KOMPRESSORIN KÄYNNISTYKSEN RELEEN KÄÄMI  
 LP: ALIPAINEPRESSOSTAATTI  
 OT: LÄHTEVÄN VEDEN LÄMPÖTILA-ANTURI  
 TC: MUUNNIN 230V~/12V~  
 4V: NELITIEVENTTIILI  
 KM1: KOMPRESSORIN KYTKIN  
 C1: JATKUVAN KÄYTÖN KONDENSAATTORI  
 C2: KÄYNNISTYKSEN KONDENSAATTORI  
 OUT2 : СВОБОДНЫЙ КОНТАКТ С МАКСИМАЛЬНЫМ ПОТЕНЦИАЛОМ 7А



## 6. LIITTEET (jatkoa)

### 6.2 Yksivaihepumpun lämmitysliitännät

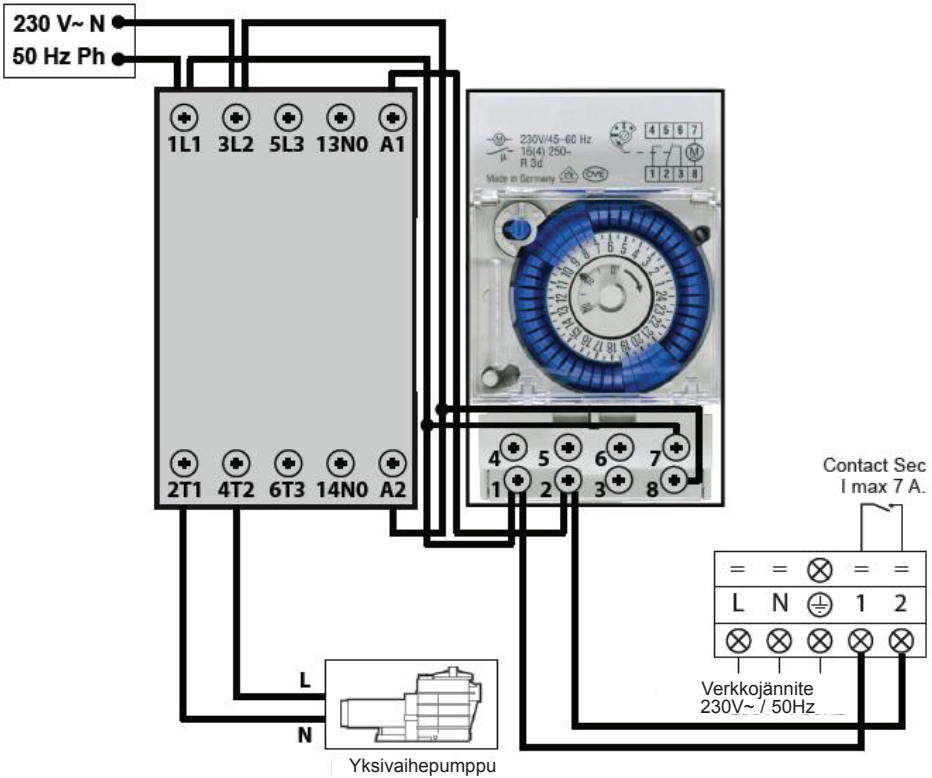

Silloin, kun suodatinpumpua ei käytetä jatkuvasti, veden lämpötilaa pitää tarkkailla käynnistämällä suodatinpumpu säännöllisin väliajoin (15 minuutin ajaksi joka toinen tunti). Jos näiden tarkkailujaksojen aikana havaitaan, että vettä täytyy lämmittää, lämpöpumppu käynnistyy.

 Älä koskaan kytke virtalähteen kiertovesipumpun suoraan napoihin 1 ja 2.



# 6. LIITTEET (jatkoa)

## 6.3 Räjätyskuvat ja varaosat

ECP 06

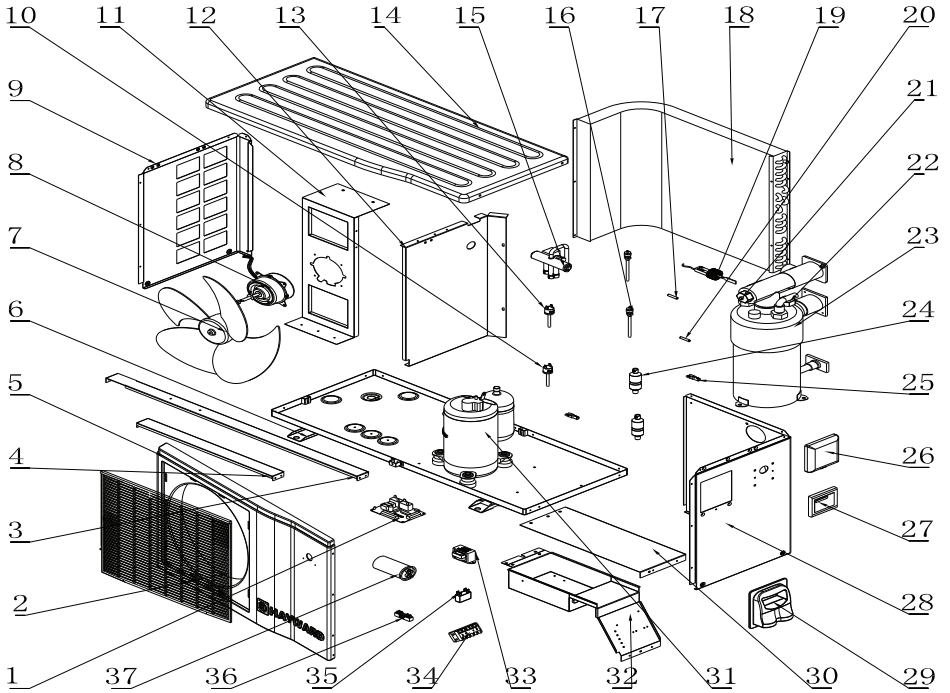

## 6. LIITTEET (jatkoa)

---

### ECP06

Kohta	Viite	Kuvaus	Kohta	Viite	Kuvaus
1	HWX950531145	Piirilevy PC1000	20	HWX20003242	Lämpötila-anturi
2	HWX35252208	Säleikkö	21	HWX20003242	Lämpötila-anturi
3	HWX322521062	Takatuki	22	HWX20003242	Lämpötila-anturi
4	HWX322521063	Etutuki	23	HWX32251210	Titaanilauhdutin/PVC
5	HWX32025210084	Etupaneeli (ABS-polymeeria)	24	HWX20041444	Suodatin (Ø 9,7-Ø 9,7)
6	HWX32025210081	Alusta	25	HWX200014068	Kapillaariliitin
7	HWX34012701	Tuulettimen lapa	26	HWX20002111	Näyttöruudun suojus
8	HWX34013301	Tuulettimen moottori	27	HWX950531188	7 segmentin näyttöruutu
9	HWX32025210083	Vasen päätylevy	28	HWX32025210082	Oikea päätylevy
10	HWX20003603	Alipainepressostaatti	29	HWX32009220054	Kahva
11	HWX322521061	Moottorin kannatin	30	HWX322521064	Suojalevy
12	HWX322521059	Erotuslevy	31	HWX200011006	Kompressorin
13	HWX20013605	Ylipainepressostaatti	32	HWX322521006	Liitäntärasia
14	HWX322522016	Pääliilevy (ABS-polymeeria)	33	HWX200037006	Muunnin 230V~/12V~
15	HWX20011418	Nelitieventtiili	34	HWX40003901	5-liitäntäinen riviliitin
16	HWX200014153	Shrader-venttiili	35	HWX20003506	Tuulettimen kondensaattori 2µF
17	HWX20003242	Lämpötila-anturi	36	HWX20003909	2-liitäntäinen riviliitin
18	HWX40001230	Höyrystin	37	HWX20003504	Kompressorin kondensaattori 35µF
19	HWX200036005	Virtausanturi	38	HWX20009910	Kapillaariputki

## 6. LIITTEET (jatkoa)

---

### ECP 08

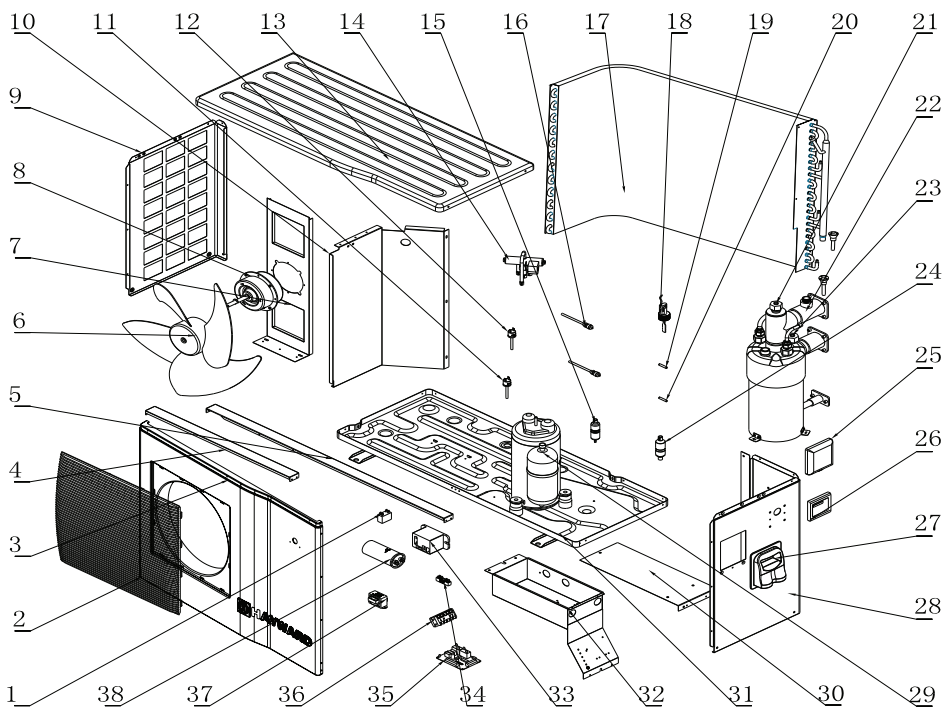

## 6. LIITTEET (jatkoa)

### ECP 08

Kohta	Viite	Kuvaus	Kohta	Viite	Kuvaus
1	HWX20003501	Tuulettimen kondensaattori 3 $\mu$ F	21	HWX20003242	Lämpötila-anturi
2	HWX35122213	Säleikkö	22	HWX32081205	Titaanilauhdutin/PVC
3	HWX32012210240	Etupaneeli (ABS-polymeria)	23	HWX20003242	Lämpötila-anturi
4	HWX321221175	Etutuki	24	HWX20041445	Filter( $\Phi$ 9.7- $\Phi$ 4.2)
5	HWX321221018	Takatuki	25	HWX20002111	Näyttöruudun suojus
6	HWX35002701	Tuulettimen lapa	26	HWX950531188	7 segmentin näyttöruutu
7	HWX321221174	Moottorin kannatin	27	HWX32009220054	Kahva
8	HWX34043301	Tuulettimen moottori	28	HWX32012210238	Oikea päätylevy
9	HWX32012210238	Vasen päätylevy	29	HWX200011135	Kompressor
10	HWX321221173	Erotuslevy	30	HWX321221019	Suojalevy
11	HWX20013605	Ylipainepressostaatti	31	HWX32012210237	Alusta
12	HWX20003603	Alipainepressostaatti	32	HWX321221176	Liitäntärasia
13	HWX32012210241	Päällilevy (ABS-polymeria)	33	HWX20003619	Rele
14	HWX20011418	Nelitieventtiili	34	HWX20003909	2-liitäntäinen riviliitin
15	HWX20041446	Suodatin ( $\emptyset$ 9,7- $\emptyset$ 3,4)	35	HWX950531145	Piirilevy PC1000
16	HWX200014153	Shrader-venttiili	36	HWX40003901	5-liitäntäinen riviliitin
17	HWX34061204	Höyrystin	37	HWX200037006	Muunnin 230V~/12V~
18	HWX200036005	Virtausanturi	38	HWX20003510	Kompressorin kondensaattori 60 $\mu$ F
19	HWX20003242	Lämpötila-anturi	39	HWX20009909	Kapillaariputki
20	HWX20003242	Lämpötila-anturi			

## 6. LIITTEET (jatkoa)

---

### ECP 11

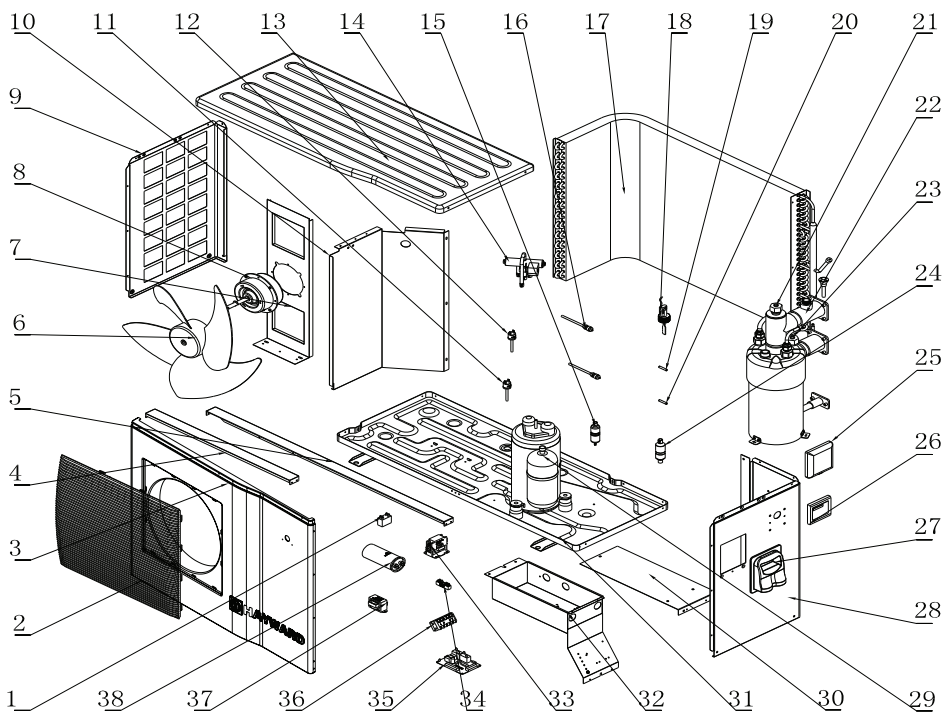

## 6. LIITTEET (jatkoa)

### ECP 11

Kohta	Viite	Kuvaus	Kohta	Viite	Kuvaus
1	HWX20003501	Tuulettimen kondensaattori 3 $\mu$ F	21	HWX20003242	Lämpötila-anturi
2	HWX35122213	Säleikkö	22	HWX32121209	Titaanilauhdutin/PVC
3	HWX32012210240	Etupaneeli (ABS-polymeeria)	23	HWX20003242	Lämpötila-anturi
4	HWX321221175	Etutuki	24	HWX20041445	Filter( $\Phi$ 9.7- $\Phi$ 4.2)
5	HWX321221018	Takatuki	25	HWX20002111	Näyttöruudun suojus
6	HWX35002701	Tuulettimen lapa	26	HWX950531188	7 segmentin näyttöruutu
7	HWX321221174	Moottorin kannatin	27	HWX32009220054	Kahva
8	HWX34043301	Tuulettimen moottori	28	HWX32012210238	Oikea päätylevy
9	HWX32012210238	Vasen päätylevy	29	HWX200011134	Kompressorin
10	HWX321221173	Erotuslevy	30	HWX321221019	Suojalevy
11	HWX20013605	Ylipainepressostaatti	31	HWX32012210237	Alusta
12	HWX20003603	Alipainepressostaatti	32	HWX321221176	Liitäntärasia
13	HWX32012210241	Päällilevy (ABS-polymeeria)	33	HWX20003619	Rele
14	HWX20011418	Nelitieventtiili	34	HWX20003909	2-liitäntäinen riviliitin
15	HWX20041446	Suodatin ( $\Phi$ 9,7- $\Phi$ 3,4)	35	HWX950531145	Piirilevy PC1000
16	HWX200014153	Shrader-venttiili	36	HWX40003901	5-liitäntäinen riviliitin
17	HWX321212002	Höyrystin	37	HWX200037006	Muunnin 230V~/12V~
18	HWX200036005	Virtausanturi	38	HWX20003505	Kompressorin kondensaattori 60 $\mu$ F
19	HWX20003242	Lämpötila-anturi	39	HWX20009909	Kapillaariputki
20	HWX20003242	Lämpötila-anturi			

## 6. LIITTEET (jatkoa)

---

### ECP 13

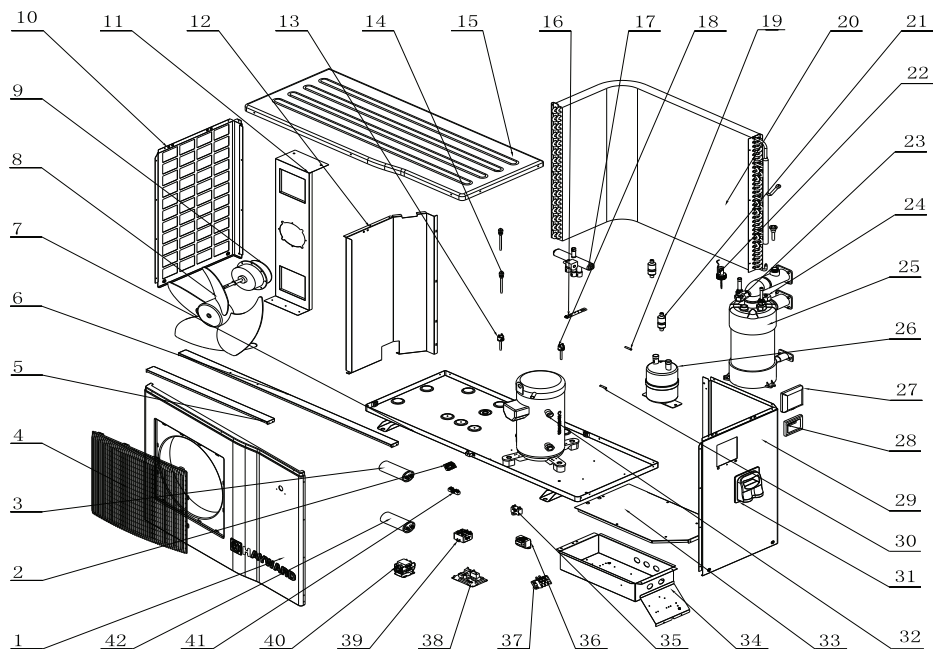



## 6. LIITTEET (jatkoa)

### ECP 13

Kohta	Viite	Kuvaus	Kohta	Viite	Kuvaus
1	HWX32009210196	Etupaneeli (ABS-polymeeria)	23	HWX20003242	Lämpötila-anturi
2	HWX20003933	3-liitäntäinen riviliitin	24	HWX20003242	Lämpötila-anturi
3	HWX20003524	Kondensaattorin käynnistys CPS 98µF	25	HWX32091206	Titaanilauhdutin/PVC
4	HWX35122213	Säleikkö	26	HWX35001401	Akku
5	HWX320921015	Etutuki	27	HWX20002111	Näyttöruudun suojus
6	HWX320921149	Takatuki	28	HWX950531188	7 segmentin näyttöruutu
7	HWX32009210193	Alusta	29	HWX32009210194	Oikea päätylevy
8	HWX35002701	Tuulettimen lapa	30	HWX20003242	Lämpötila-anturi
9	HWX34043301	Tuulettimen moottori	31	HWX32009220054	Kahva
10	HWX32009210195	Vasen päätylevy	32	HWX20011170	Kompressorin
11	HWX320921147	Moottorin kannatin	33	HWX320921152	Suojalevy
12	HWX320921148	Erotuslevy	34	HWX320921151	Liitäntärasia
13	HWX20013605	Ylipaineestaasti	35	HWX20003501	Tuulettimen kondensaattori 3µF
14	HWX200014153	Shrader-venttiili	36	HWX200037006	Muunnin 230V~/12V~
15	HWX32009210197	Päälilevy (ABS-polymeeria)	37	HWX20003920	3-liitäntäinen riviliitin
16	HWX20001489	Rajoitin	38	HWX950531145	Piirilevy PC1000
17	HWX20011491	Neilitieventtiili	39	HWX20003676	Rele
18	HWX20003603	Alipaineestaasti	40	HWX200036007	Kompressorin kytkin
19	HWX20003242	Lämpötila-anturi	41	HWX20003909	2-liitäntäinen riviliitin
20	HWX351212001	Höyrystin	42	HWX20003510	Kompressorin kondensaattori 60µF
21	HWX20041444	Suodatin (Ø 9,7-Ø 9,7)	43	HWX20009909	Kapillaariputki
22	HWX200036005	Virtausanturi			

## 6. LIITTEET (jatkoa)

---

### ECP 15

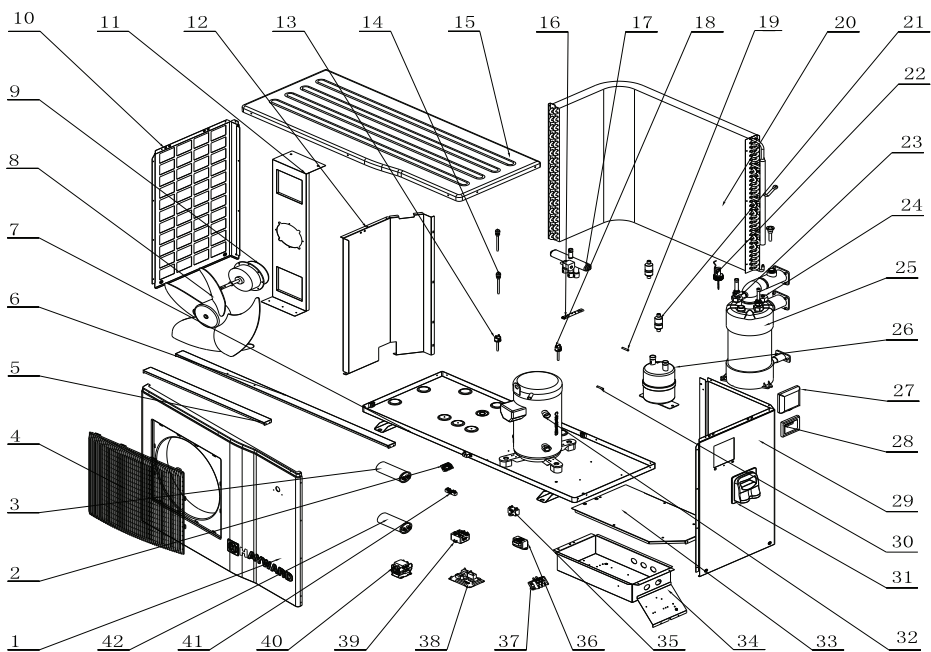

## 6. LIITTEET (jatkoa)

### ECP 15

Kohta	Viite	Kuvaus	Kohta	Viite	Kuvaus
1	HWX32009210196	Etupaneeli (ABS-polymeeria)	23	HWX20003242	Lämpötila-anturi
2	HWX20003933	3-liitäntäinen riviliitin	24	HWX20003242	Lämpötila-anturi
3	HWX20003524	Kondensaattorin käynnistys CPS 98µF	25	HWX32091206	Titaanilauhdutin/PVC
4	HWX35122213	Säleikkö	26	HWX35001401	Akku
5	HWX320921015	Etutuki	27	HWX20002111	Näyttöruudun suojus
6	HWX320921149	Takatuki	28	HWX950531188	7 segmentin näyttöruutu
7	HWX32009210193	Alusta	29	HWX32009210194	Oikea päätylevy
8	HWX35002701	Tuulettimen lapa	30	HWX20003242	Lämpötila-anturi
9	HWX34043301	Tuulettimen moottori	31	HWX32009220054	Kahva
10	HWX32009210195	Vasen päätylevy	32	HWX20011169	Kompressorin
11	HWX320921147	Moottorin kannatin	33	HWX320921152	Suojalevy
12	HWX320921148	Erotuslevy	34	HWX320921151	Liitäntärasia
13	HWX20013605	Ylipainepressostaatti	35	HWX20003501	Tuulettimen kondensaattori 3µF
14	HWX200014153	Shrader-venttiili	36	HWX200037006	Muunnin 230V~/12V~
15	HWX32009210197	Päälilevy (ABS-polymeeria)	37	HWX20003920	3-liitäntäinen riviliitin
16	HWX20001489	Rajoitin	38	HWX950531145	Piirilevy PC1000
17	HWX20011491	Nelitieventtiili	39	HWX20003676	Rele
18	HWX20003603	Alipainepressostaatti	40	HWX200036007	Kompressorin kytkin
19	HWX20003242	Lämpötila-anturi	41	HWX20003909	2-liitäntäinen riviliitin
20	HWX351212001	Höyrystin	42	HWX20003510	Kompressorin kondensaattori 60µF
21	HWX20041444	Suodatin (Ø 9,7-Ø 9,7)	43	HWX20009909	Kapillaariputki
22	HWX200036005	Virtausanturi			

## 6. LIITTEET (jatkoa)

### 6.4 Vianetsintä



**Tietyt työt on jätettävä alan ammattilaisen tehtäväksi.**

Toimintahäiriö	Virhekoodit	Kuvaus	Ratkaisu
Häiriö tulovesianturissa	P01	Anturi on auki tai siinä on oikosulku	Tarkista tai vaihda anturi.
Häiriö lähtevän veden anturissa	P02	Anturi on auki tai siinä on oikosulku	Tarkista tai vaihda anturi.
Häiriö ulkolämpötila-anturissa	P04	Anturi on auki tai siinä on oikosulku	Tarkista tai vaihda anturi.
Häiriö jäätymisanturissa	P05	Anturi on auki tai siinä on oikosulku	Tarkista tai vaihda anturi.
Ylipaineessostaatti on lauennut	E01	Jäähdytyskanavan paine on liian suuri tai veden virtaama liian heikko tai höyrystin on tukossa tai ilmavirtaus on liian heikko.	Tarkista ylipaineessostaatti ja jäähdytyskanavan paine Tarkista vedenvirtaama tai ilmavirtaus. Varmista, että virtausanturi toimii moitteettomasti. Tarkista, että veden tulo-/lähtöventtiilit ovat auki. Tarkista ohitusventtiilin säädöt.
Alipaineessostaatti on lauennut	E02	Jäähdytyskanavan paine tai ilmavirta on liian pieni tai höyrystin on tukossa.	Tarkista alipaineessostaatti ja jäähdytyskanavan paine varmistaaksesi, ettei niissä ole vuotoja. Puhdista höyrystimen pinta. Tarkista tuulettimen pyörimisnopeus. Tarkista, että ilma pääsee kulkemaan vapaasti höyrystimen läpi.
Häiriö virtausanturissa	E03	Veden virtaama ei ole riittävä tai anturissa on oikosulku tai anturi on viallinen.	Tarkista veden virtaama, suodatinpumppu ja virtausanturi toimintahäiriöiden varalta.
Tulevan ja lähtevän veden lämpötilaero on liian suuri	E06	Veden virtaama on liian heikko, veden paine-ero on liian pieni/suuri.	Tarkista veden virtaama ja varmista, ettei järjestelmässä ole tukoksia.
Jäätymisanturi on lauennut Jäähdytystoiminto	E07	Lähtevän veden määrä liian pieni.	Tarkista veden virtaama tai lähtevän veden lämpötila-anturi.
Yhteyshäiriö	E08	LED-näytön toimintahäiriö tai häiriö piirilevylitännässä	Tarkista johtojen liitännät.
1. jäätymisanturi	E19	Ympäristön lämpötila on liian alhainen ja tuloveden määrä liian pieni.	Pysäytä lämpöpumppu ja tyhjennä siitä kaikki vesi pois. Jäätymisvaara.
2. jäätymisanturi	E29	Ympäristön lämpötila ja tuloveden määrä edelleen liian alhaiset.	Pysäytä lämpöpumppu ja tyhjennä siitä kaikki vesi pois. Jäätymisvaara.

## 6. LIITTEET (jatkoa)

---

### 6.5 Takuu

#### TAKUUEHDOT

Kaikille HAYWARD-tuotteille myönnetään takuu materiaali- ja valmistusvirheiden varalta. Takuu on voimassa 2 vuotta ostopäivästä. Takuuta koskeviin vaatimuksiin tulee liittää ostokuitti, josta näkyy ostopäivä. Säilytä siis ostokuitti.

HAYWARD-takuu kattaa HAYWARDin valinnan mukaan joko viallisen tuotteen korjauksen tai vaihdon uuteen, edellyttäen, että tuote on vioittunut tavanomaisessa käyttöohjeen mukaisessa käytössä ja ettei tuotteeseen ole tehty mitään muutoksia ja että siinä on käytetty ainoastaan alkuperäisiä HAYWARD-osia. Takuu ei kata jäätymisestä aiheutuvia eikä kemikaalien aiheuttamia vikoja.

Mitkään muut kulut (kuljetus, työ, jne.) eivät kuulu takuun piiriin.

HAYWARD ei vastaa mistään vahingoista, jotka aiheutuvat joko suoraan tai välillisesti tuotteen virheellisestä asennuksesta, liitännöistä tai käytöstä.

Käännä takuukysymyksissä jälleenmyyjän puoleen. Emme ota vastaan tuotepalautuksia, joista ei ole sovittu kirjallisesti etukäteen.

Kuluvat osat eivät kuulu takuun piiriin.

# EASY TEMP

## VÄRMEPUMP FÖR BASSÄNG

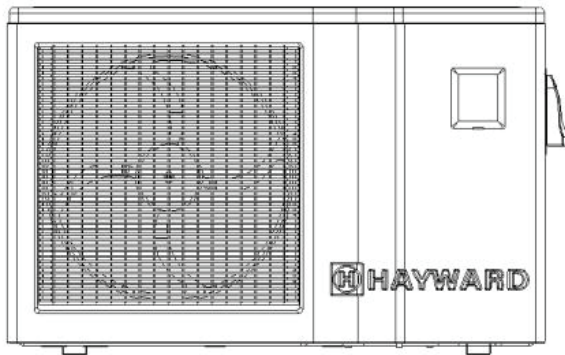

**Bruksanvisning och installationsmanual**

# SAMMANFATTNING

---

<b>1. Förord</b>	<b>1</b>
<hr/>	
<b>2. Tekniska egenskaper</b>	<b>2</b>
2.1 Tekniska data för värmepumpen	2
2.2 Arbetsområde	3
2.3 Dimensioner	4
<hr/>	
<b>3. Installation och anslutning</b>	<b>5</b>
3.1 Principschema	5
3.2 Värmepump	5
3.3 Hydraulisk anslutning	6
3.4 Elektrisk anslutning	7
3.5 Första starten	8
3.6 Inställning av vattenflödet	10
<hr/>	
<b>4. Användargränssnitt</b>	<b>11</b>
4.1 Allmän presentation	11
4.2 Inställning av klockan	13
4.3 Inställning av timerns funktion	13
4.4 Val av funktionsläge: uppvärmning eller kylning	14
4.5 Inställning och visning av börvärdet	15
4.6 Läsning och uppläsning av användargränssnittet	15
<hr/>	
<b>5. Underhåll och förberedelser inför vintern</b>	<b>16</b>
5.1 Underhåll	16
5.2 Förberedelser inför vintern	16
<hr/>	
<b>6. Bilagor</b>	<b>17</b>
6.1 Kopplingsscheman	17
6.2 Anslutningar prioritet uppvärmning	22
6.3 Sprängvyer och reservdelar	23
6.4 Vägledning för reparation	33
6.5 Garanti	34

Skall läsas uppmärksamt och bevaras för senare konsultation.

Detta dokument måste lämnas tillbaka till bassängens ägare och måste förvaras av denne på ett säkert ställe.

# 1. FÖRORD

---

Vi tackar dig för att du har köpt denna värmepump för bassänger av Easy Temp. Denna produkt har konstruerats enligt stränga tillverkningsstandarder för att uppnå den erforderade kvalitetsnivån. Denna bruksanvisning innefattar all den information som är nödvändig för installation, åtgärdande av funktionsfel och underhåll. Läs denna bruksanvisning uppmärksam innan du öppnar enheten eller genomför underhållsarbete på den. Tillverkaren av denna produkt kan inte i något fall hållas ansvarig i händelse av att en användare skadas eller en enhet skadas till följd av eventuella fel under installationen, åtgärdande av funktionsfel eller felaktigt underhåll. Det är mycket viktigt att i varje ögonblick följa de instruktioner som anges i denna bruksanvisning. Enheten måste installeras av en behörig person.

- Reparationerna måste utföras av en behörig person.
- Alla elektriska anslutningar måste utföras av en behörig elektriker och enligt de standarder som gäller i det land där enheten installeras, se § 3.4.
- Underhållet och de olika arbetsstegen måste utföras med den rekommenderade frekvensen och vid de rekommenderade ögonblicken, såsom angivet i denna bruksanvisning.
- Använd bara originalreservdelar.
- Om rekommendationerna inte följs gäller inte garantin.
- Denna värmepump värmer upp vattnet i bassängen och håller det vid en konstant temperatur, använd den inte för andra ändamål.

När du har läst denna bruksanvisning, förvara den med tanke på senare användning.

Varningar avseende barn/personer med nedsatt fysisk förmåga:

Denna apparat är inte avsedd att användas av personer (i synnerhet barn) vilkas fysiska och intellektuella förmågor eller sinnesförmågor är nedsatta, eller av personer som saknar erfarenhet eller kännedom, om de inte är övervakade eller om de inte har fått instruktioner om användningen av apparaten av en person som är ansvarig för deras säkerhet.

Denna produkt innehåller fluorerade växthusgaser som omfattas av Kyoto-protokollet.

Typ av kylmedel: R410A

GWP-värde<sup>(1)</sup>: 1975

Periodiska inspektioner av kylmedelsläckor kan fordras beroende på den europeiska eller lokala lagstiftningen. Vänligen kontakta din lokale leverantör för mer information.

---

(1) Potential för övergripande uppvärmning



## 2. TEKNISKA EGENSKAPER

### 2.1 Tekniska data för värmepumpen

Modell	EASY TEMP	ECP 06	ECP 08	ECP 11	ECP 13	ECP 15
Uppvärmningseffekt *	kW BTU/h	5,5 18785	8 27322	11 37566	13,5 46105	15 51228
Elektrisk effekt	kW	1,17	1,8	2,43	3	3,13
Driftström*	A	5,19	7,91	11,81	14,5	16
Strömförsörjning	V pH/Hz	230 V~ 1/50 Hz	230 V~ 1/50 Hz	230 V~ 1/50 Hz	230 V~ 1/50 Hz	230 V~ 1/50 Hz
Dimension säkring typ aM	A	8 aM	10 aM	16 aM	20 aM	20 aM
brytare typ D	A	8 D	10 D	16 D	20 D	20 D
Antal kompressorer		1	1	1	1	1
Typ av kompressor		Centrifugalkompressor	Centrifugalkompressor	Centrifugalkompressor	Spiralhus	Spiralhus
Antal fläktar		1	1	1	1	1
Fläktens effekt	W	50	120	120	120	120
Fläktens rotationshastighet	varv/minut	770	850	850	850	850
Fläktens riktning		Horisontell	Horisontell	Horisontell	Horisontell	Horisontell
Ljudtrycksnivån (på 1 meters avstånd)	dB(A)	47	51	54	56	56
Hydraulisk anslutning	mm	50	50	50	50	50
Vattenflöde	m <sup>3</sup> /timme	2,3	3,0	4,5	5,3	6,6
Vattnets tryckfall (maximalt)	kPa	5,4	8,9	19,2	5,2	39,9
Enhetens nettodimensioner (längd/bredd/höjd)	mm	895/375/545	1035/415/650	1035/415/650	1136/440/870	1136/440/870
Den förpackade enhetens mått (längd/bredd/höjd)	mm	970/430/710	1120/480/810	1180/480/810	1230/510/1020	1230/510/1020
Nettovikt/den förpackade enhetens vikt	kg	45/56	54/68	60/74	95/115	117/128



\* Värde på ± 5 % under följande betingelser: Yttertemperatur = 24 °C (75 °F) / relativ luftfuktighet = 62 % / Bassängens temperatur = 27 °C (80 °F)

## 2. TEKNISKA EGENSKAPER (fortsättning)

---

### 2.2 Driftintervall

Använd värmepumpen inom följande temperatur- och fuktighetsintervall för att säkerställa säker och effektiv funktion.

	Läge uppvärmning 	Läge kylning 
Yttertemperatur	+2 °C ~ +35 °C	+7 °C ~ +43 °C
Vattentemperatur	+12 °C ~ +40 °C	+8 °C ~ +40 °C
Relativ fuktighet	< 80%	< 80%
Inställningsintervall börvärde	+15 °C ~ +40 °C	+8 °C ~ +35 °C



***Om temperaturen eller fuktigheten inte uppfyller dessa villkor, kan säkerhetsanordningar utlösas och värmepumpen kommer inte längre att kunna fungera.***

## 2. TEKNISKA EGENSKAPER (fortsättning)

### 2.3 Dimensioner

Modeller: ECP06 / ECP08 / ECP11 / ECP13 / ECP15

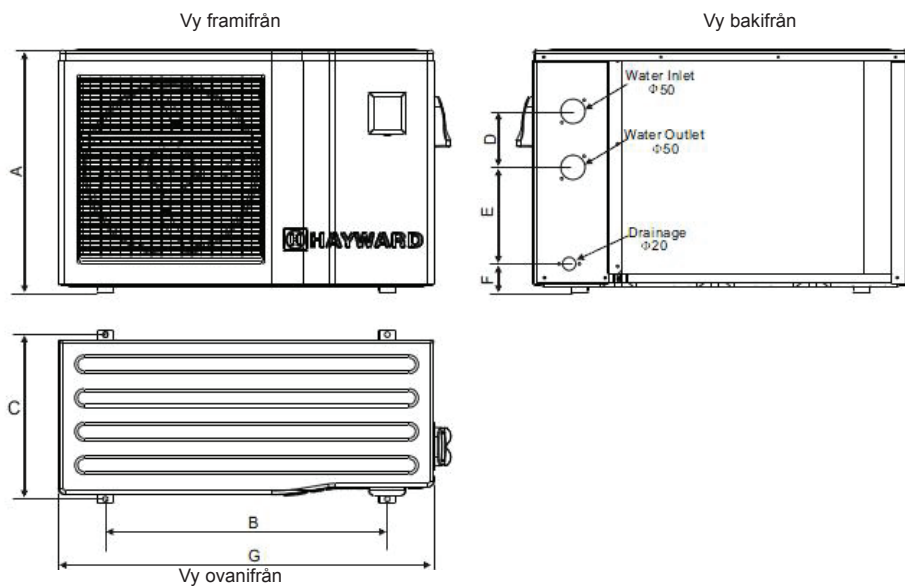

Enhet: mm

Modell	ECP06	ECP08 ECP11	ECP13 ECP15
Hänvisnings- tecken			
<b>A</b>	540	648	866
<b>B</b>	571	755	840
<b>C</b>	400	440	470
<b>D</b>	140	150	150
<b>E</b>	258	258	330
<b>F</b>	66	77	80
<b>G</b>	860	1004	1114

## 3. INSTALLATION OCH ANSLUTNING

### 3.1 Principschema

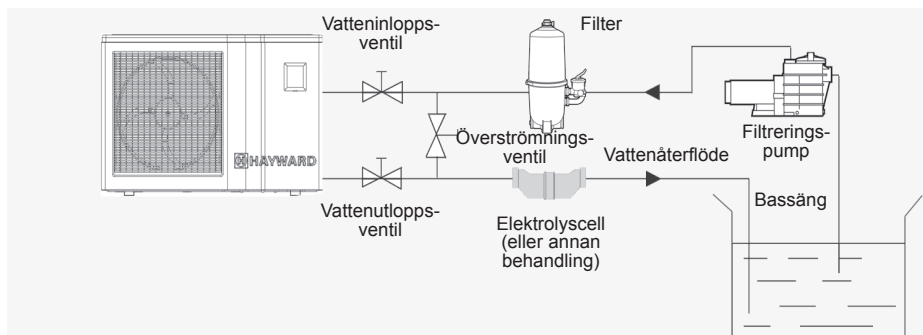

Anmärkning: Värmpumpen levereras utan någon behandlings- eller filtreringsutrustning. Elementen som visas på schemat är delar som installatören måste tillhandahålla.

### 3.2 Värmpump



**Placera värmpumpen på utsidan av och utanför varje tekniskt slutet lokal.**

**Placera den under ett regnskydd, de nedan beskrivna minimiavstånden måste iaktas för att undvika varje risk för återcirkulering av luft och en försämring av värmpumpens övergripande prestanda.**

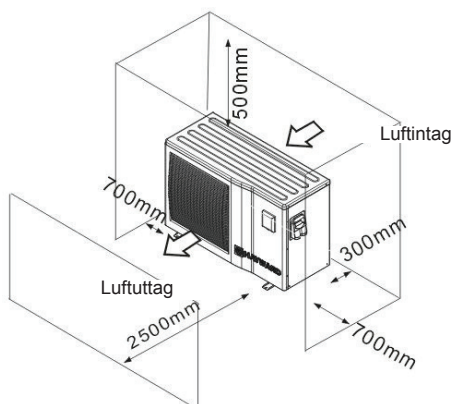

### 3. INSTALLATION OCH ANSLUTNING (fortsättning)



*Installera helst värmepumpen på en avskild betongplatta eller på ett fästfundament som är anordnat i detta syfte och montera värmepumpen på de tillhandahållna ljuddämpningsblocken (skruvar och brickor ingår inte i leveransen).*

*Det maximala installationsavståndet mellan pumpen och bassängen är 15 meter.*

*De fram- och återgående rörledningarnas sammanlagda längd blir då 30 meter.*

*Isolera de hydrauliska rörledningarna som ligger ytan och dem som är nedgrävda.*

#### 3.3 Hydraulisk anslutning

Värmepumpen är försedd med två skarvanslutningar med en diameter på 50 mm. Använd PVC-rör för den hydrauliska rörledningen  $\varnothing$  50 mm. Anslut värmepumpens vatteninlopp till ledningen som kommer från filtreringsenheten och anslut sedan värmepumpens vattenutlopp till vattenledningen som går till bassängen (se schemat nedan).

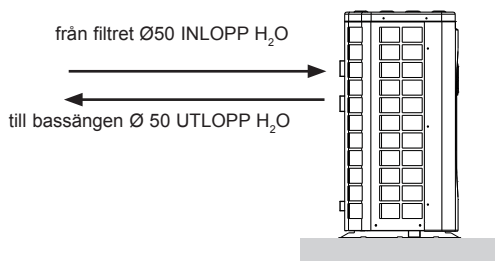

Installera en så kallad "överströmningsventil" mellan värmepumpens in- och utlopp.



*Om en automatisk distributör eller elektrolysapparat används, måste den absolut installeras efter värmepumpen i syfte att skydda Titan-kondensorn mot en alltför hög koncentration av kemikalier.*



*Se till att installera överströmningsventilen och de tillhandahållna skarvanslutningarna ordentligt vid enhetens vatteninlopp och -utlopp, för att underlätta rensningen under vintersäsongen, underlätta åtkomsten av enheten eller för att göra det lättare att demontera den.*

### 3. INSTALLATION OCH ANSLUTNING (fortsättning)

#### 3.4 Elektrisk anslutning



**Den elektriska installeringen av och kabelföringen för denna utrustning måste uppfylla de lokalt gällande reglerna för installering.**

F	NF C15-100	GB	BS7671:1992
D	DIN VDE 0100-702	EW	EVHS-HD 384-7-702
A	ÖVE 8001-4-702	H	MSZ 2364-702/1994/MSZ 10-553 1/1990
E	UNE 20460-7-702 1993, RECBT ITC-BT-31 2002	M	MSA HD 384-7-702.S2
IRL	Wiring Rules + IS HD 384-7-702	PL	PN-IEC 60364-7-702:1999
I	CEI 64-8/7	CZ	CSN 33 2000 7-702
LUX	384-7.702 S2	SK	STN 33 2000-7-702
NL	NEN 1010-7-702	SLO	SIST HD 384-7-702.S2
P	RSIUEE	TR	TS IEC 60364-7-702



**Kontrollera att den tillgängliga strömförsörjningen och nätets frekvens motsvarar den erfordrade driftströmmen, genom att ta hänsyn till apparatens specifika placering och den ström som är nödvändig för försörja varje annan apparat som är ansluten till samma krets.**

**ECP 06 230 V~ +/- 10 % 50 Hz 1 fas**

**ECP 08 230 V~ +/- 10 % 50 Hz 1 fas**

**ECP 11 230 V~ +/- 10 % 50 Hz 1 fas**

**ECP 13 230 V~ +/- 10 % 50 Hz 1 fas**

**ECP 15 230 V~ +/- 10 % 50 Hz 1 fas**

**Observera det motsvarande kopplingsschemat i bilagan.**

**Anslutningsdosan är placerad på enhetens högra sida. Tre anslutningar är avsedda för strömförsörjningen och två för styrning av filteringspumpen (servomotor).**

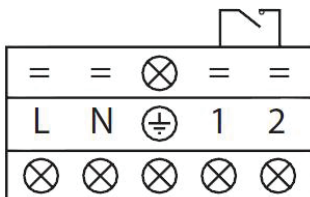

Strömförsörjningsenhet  
230 V~ / 50 Hz

Utgång 230 V~  
Servomotor filterings-  
pump 7 A max

### 3. INSTALLATION OCH ANSLUTNING (fortsättning)

---



**Strömförsörjningsledningen måste på lämpligt sätt vara försedd med säkringsskyddsanordning av typen strömförsörjare till motorn (aM) eller strömbrytare av typ D liksom med en jordfelsbrytare på 30 mA (se tabellen nedan).**

Modeller		ECP 06	ECP 08	ECP 11	ECP 13	ECP 15
Strömförsörjning	V/fas/ Hz	230 V~ 1/50 Hz	230 V~ 1/50 Hz	230 V~ 1/50 Hz	230 V~ 1/50 Hz	230 V~ 1/50 Hz
Dimension säkring typ aM	A	8 aM	10 aM	16 aM	20 aM	20 aM
Brytare typ D	A	8 D	10 D	16 D	20 D	20 D



**Se alltid till att stänga av huvudströmförsörjningen innan den elektriska manöverdosan öppnas.**

#### 3.5 Första starten

Startprocedur - följ och iakttag följande steg, så snart som installationen avslutats:

- 1) Vrid fläkten för hand för att kontrollera att den kan rotera fritt, och att spiralen är fäst på rätt sätt på motoraxeln.
- 2) Säkerställ att enheten är ansluten på rätt sätt till huvudströmförsörjningen (se kopplingschemat i bilagan).
- 3) Sätt igång filtreringspumpen.
- 4) Kontrollera att alla vattenventiler är öppna, och att vattnet strömmar mot enheten innan den övergår till uppvärmningsläge eller kyläge.
- 5) Kontrollera att röret för tömning av kondensat är fäst på rätt sätt och inte är tilltäppt.
- 6) Slå på strömförsörjningen som är avsedd för enheten, och tryck sedan på knappen Drift/Stopp.  på manöverpanelen.

### **3. INSTALLATION OCH ANSLUTNING (fortsättning)**

---

- 7) Säkerställ att ingen LARM-kod visas när enheten befinner sig på ON (se reparationsvägledningen).
- 8) Ställ in vattenflödet med hjälp av överströmningsventilen (se § 3.6 och 2.1) såsom avsett för varje modell för sig, för att erhålla en temperaturskillnad Inlopp/Utlopp på 2 °C.
- 9) Kontrollera efter några minuters drift att luften som strömmar ut från enheten är kyld (mellan 5 och 10 °C).
- 10) Stäng av filtreringspumpen när enheten är i drift. Enheten skall stanna automatiskt och visa felkoden E03.
- 11) Håll igång enheten och bassängens pump 24 timmar per dygn tills den önskade vattentemperaturen har uppnåtts. När vattnets inloppstemperatur uppnår börvärdet, stannar enheten. Den återstartar automatiskt (så länge som bassängens pump är i drift) om bassängens temperatur understiger börvärdestemperaturen med minst 0,5 °C.

**Flödesövervakningsanordning** - Enheten är försedd med en flödesövervakningsanordning som sätter igång värmepumpen när bassängens filtreringspump är i drift, och stänger av den när filtreringspumpen inte är i drift. Vid vattenbrist visas larmkoden E03 på inställningsenheten (se § 6.4).

**Tidsfördröjning** - enheten innefattar en tidsfördröjning på 3 minuter, för att skydda styrkretsarnas komponenter, avlägsna varje instabilitet vid återstart och varje störning vid kontaktorn. Tack vare denna tidsfördröjning, återstartar enheten automatiskt omkring 3 minuter efter varje brytning av styrkretsen. Till och med ett kortvarigt strömavbrott aktiverar fördröjningen av återstarten.



## 3. INSTALLATION OCH ANSLUTNING (fortsättning)

### 3.6 Inställning av vattenflödet

Justera den så kallade "överströmningsventilen" när värmepumpen är i drift och vatteninlopps- och vattenutloppsventilerna är öppna, för att erhålla en temperaturskillnad på 2 °C mellan vattnets inlopps- och utloppstemperatur (se principalschemat § 3.1). Du kan kontrollera inställningen genom att åskådliggöra inloppstemperaturen (T02)/utloppstemperaturen (T03) direkt på manöverpanelen genom att följa nedanstående procedur.

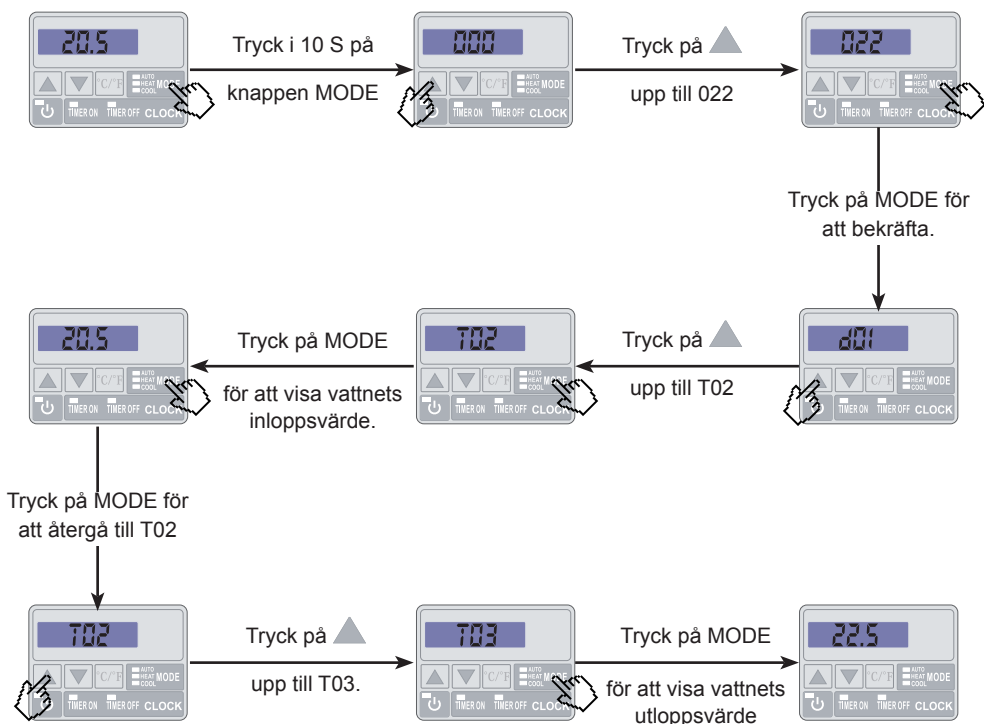

Ställ sedan in din överströmningsventil för att erhålla en temperaturskillnad på 2°C mellan T03 och T02 ( $T03 - T02 = \Delta T = 2$ ).

Tryck 2 gånger på  för att lämna menyn.

Anmärkning: När den så kallade "överströmningsventilen" öppnas, minskar flödet vilket leder till att  $\Delta T$  ökar.

När den så kallade "överströmningsventilen" stängs, ökar flödet vilket leder till att  $\Delta T$  minskar.

## 4. ANVÄNDARGRÄNSSNITT

---

### 4.1 Allmän visning

Värmepumpen är försedd med en elektronisk manöverpanel som är elektriskt ansluten och förinställt i uppvärmningsläge i fabriken.

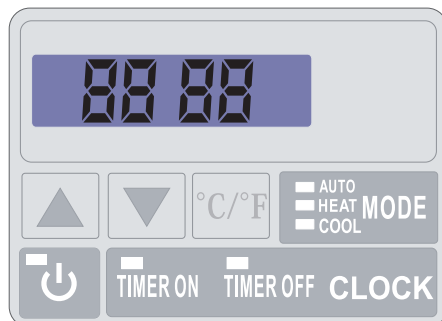

#### Teckenförklaring

-  **COOL** Symbol för kyläge
-  **HEAT** Symbol för uppvärmningsläge
-  **AUTO** Automatiskt läge
-  **CLOCK** Tidsinställning och Timer
-  **MODE** Urvals- och inställningsknapp
-  Knapp för drift/stopp och retur/bekräftelse
-  Låg spolning
-  Hög spolning
-  **TIMER ON** Tidsinställning drift
-  **TIMER OFF** Tidsinställning stopp

## 4. ANVÄNDARGRÄNSSNITT (fortsättning)

---

### Läge OFF

När värmepumpen befinner sig i vänteläge (läge OFF) visas tiden liksom funktionsläget på inställningsenhetens skärm.

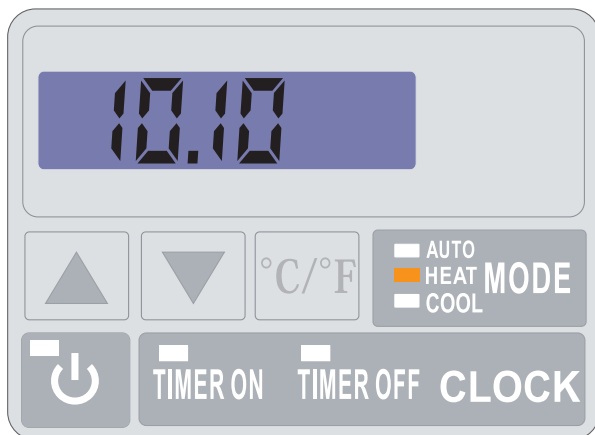

### Läge ON



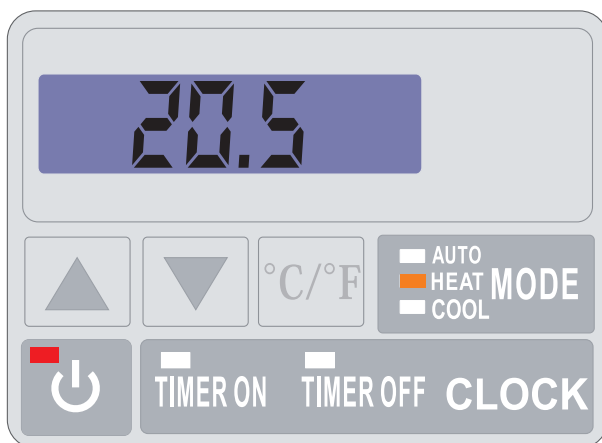

När värmepumpen är i drift eller under inställning (läge ON) lyser driftknappens lampa i rött och vattnet inloppstemperatur visas på skärmen.



## 4. ANVÄNDARGRÄNSSNITT (fortsättning)

---

### 4.2 Inställning av klockan





Inställningen av klockan kan utföras i läge ON eller i läge OFF. Tryck på «CLOCK», varigenom visningsenheten blinkar och tryck sedan på «CLOCK» varigenom timmarna blinkar. Ställ in timmarna med pilarna  eller  tryck sedan ytterligare en gång på «CLOCK» för att välja ut minuterna. Ställ in minuterna med hjälp av pilarna  eller . Tryck på «CLOCK» för att bekräfta. Visningsenheten återgår till sitt föregående tillstånd.

Anmärkning: Inställningarna sparas med knappen «CLOCK» eller automatiskt om ingen tangent vidrörs inom 5 sekunder.

### 4.3 Inställning av Timer-funktionen

Inställningen av denna funktion är nödvändig från det ögonblick då du önskar att ta din värmepump i drift under en kortare period än den som definierats av filteringsklockan. På detta sätt kan du programmera en uppskjuten starttid och ett förväntat stopp eller helt enkelt utesluta ett tidsintervall för driften (till exempel natten).





#### Programmering av starttiden (Timer ON) / drift

- 1) Tryck på «Timer ON», timmen blinkar.
- 2) Tryck på «Timer ON» för att ställa in timmarna med hjälp av knapparna  .
- 3) Tryck på «Timer ON» för att ställa in minuterna med hjälp av knapparna  .

Inställningarna sparas med hjälp av knappen «Timer ON» eller automatiskt om ingen tangent vidrörs inom 5 sekunder.

En grön lampa anger att timern är aktiverad.

#### Programmering av stopp (Timer OFF) / Stopp

- 1) Tryck «Timer OFF», timmen blinkar.
- 2) Tryck «Timer OFF» för att ställa in timmarna med hjälp av knapparna  .
- 3) Tryck på «Timer OFF» för att ställa in minuterna med hjälp av knapparna  .



Inställningarna sparas med knappen «Timer OFF» eller automatiskt om tangenterna inte vidrörs inom 5 sekunder.

En röd lampa anger att timern är aktiverad.

## 4. ANVÄNDARGRÄNSSNITT (fortsättning)

---

Avstängning av Timern (Timer ON och OFF) / Stopp och drift

- 1)\_Tryck på "Timer ON", "Timer ON" blinkar.
- 2)\_Tryck för att  stänga av programmeringen.
- 3)\_Tryck på "Timer OFF", "Timer OFF" blinkar
- 4)\_Tryck för att  stänga av programmeringen.

### 4.4 Val av funktionsläge: uppvärmning, kylning eller automatiskt läge.

I läge "OFF" eller "ON"

Tryck på knappen «MODE» för att övergå från kylläge (grön lampa) till uppvärmningsläge (brandgul lampa) till automatiskt läge (röd lampa).



## 4. ANVÄNDARGRÄNSSNITT (fortsättning)

---



### 4.5 Inställning och visning av börvärdet (önskad vattentemperatur)

I läge "OFF" och läge "ON"

Tryck på knapparna  eller  för att definiera det önskade börvärdet. Inställningen genomförs med en precision på 0,5 °C.



*Det rekommenderas att en temperatur på 30 °C aldrig överskrids för att undvika att ledningarna ändras.*

Anmärkning: I drift eller vid stopp räcker det att trycka på knappen  eller  för att åskådliggöra eller ändra börvärdet.

### 4.6 Låsning och upplåsning av pekskärmen

Tryck på knappen drift/stopp i  5 sekunder tills ett pip ljuder. Tangenterna blir inaktiva.

Tryck på  i 5 sekunder tills ett pip ljuder, för att låsa upp. Tangenterna blir åter aktiva.

## 5. UNDERHÅLL OCH FÖRBEREDELSE INFÖR VINTERN

---

### 5.1 Underhåll

Dessa underhållsåtgärder måste utföras en gång per år för att säkerställa värmepumpens livslängd och dess felfria funktion.

- Rengör förångaren med hjälp av en mjuk borste eller en luft- eller vattenstråle (**Se till att aldrig använda en högtrycksspruta**).
- Kontrollera att kondensatet strömmar ordentligt.
- Kontrollera att de elektriska och hydrauliska ledningarna är åtdragna.
- Kontrollera att kondensorns är hydrauliskt tät.



***Värmepumpen måste kopplas loss från varje elektrisk strömkälla före allt underhållsarbete. Underhållsarbetet får endast utföras av behörig personal som är klädd för att hantera kylvätskor***

### 5.2 Förberedelser inför vintern

- Ställ värmepumpen i läge "OFF".
- Stäng av värmepumpens strömförsörjning.
- Töm kondensorn med hjälp av avloppet för att undvika varje risk för skada. (Stor risk för frost).
- Stäng "överströmningsventilen" och skruva loss skarvanslutningarna till inloppet/utloppet.
- Avlägsna det stillastående vattnet i kondensorn så mycket som möjligt med hjälp av en tryckluftspistol.
- Täpp till värmepumpens vatteninlopp och -utlopp för att undvika att främmande föremål kommer in.
- Täck värmepumpen med en vinterpresenning (ingår ej i leveransen).



***Varje skada som orsakats av dåliga vinterförberedelser medför att garantin blir ogiltig.***

# 6. BILAGOR

## 6.1 Kopplingscheman

ECP 06

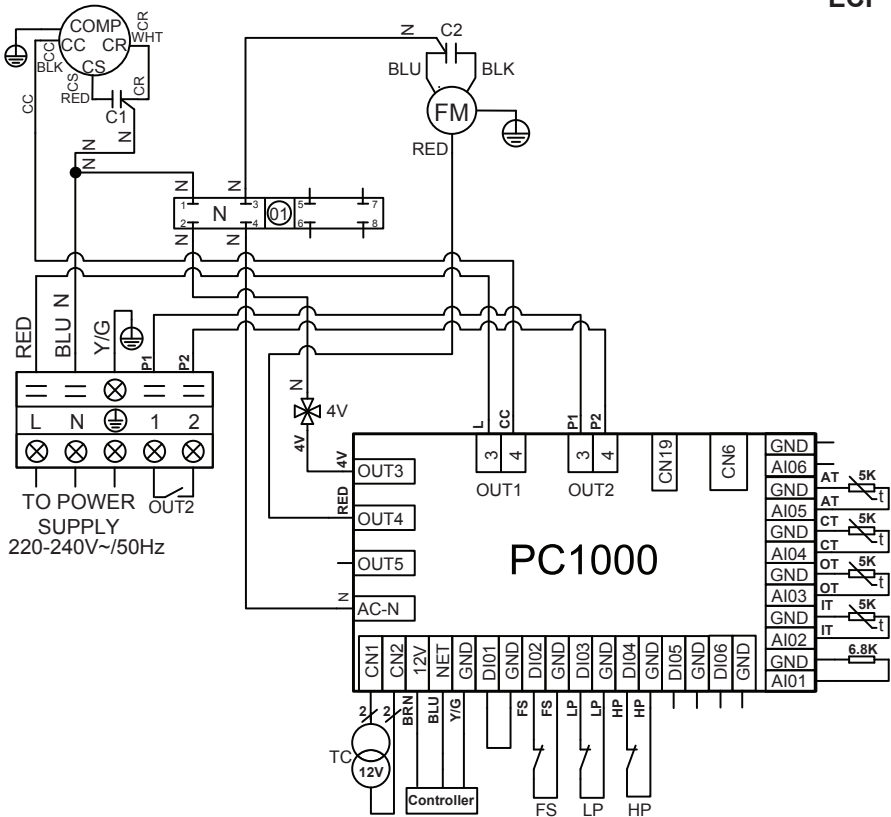

### ANMÄRKNINGAR:

AT: LUFTTEMPERATURSOND

COMP: KOMPRESOR

CT: TEMPERATURSOND FÖRÄNGARE

FM: FLÄKTMOTOR

FS: DETEKTOR FÖR VATTENFÖREKOMST

HP: PRESSOSTAT HÖGT TRYCK

IT: TEMPERATURSOND VATTENINLOPP

LP: PRESSOSTAT LÄGT TRYCK

OT: TEMPERATURSOND VATTENUTLOPP

TC: TRANSFORMATOR 230 V~ / 12 V~

4V: FYRVÄGSVENTIL

C1: KONDESATOR KOMPRESOR

C2: KONDESATOR FLÄKT

OUT2 : CONTATTO PULITO LIBERO DA POTENZIALE

7A MAX.



## 6. BILAGOR (fortsättning)

ECP 08

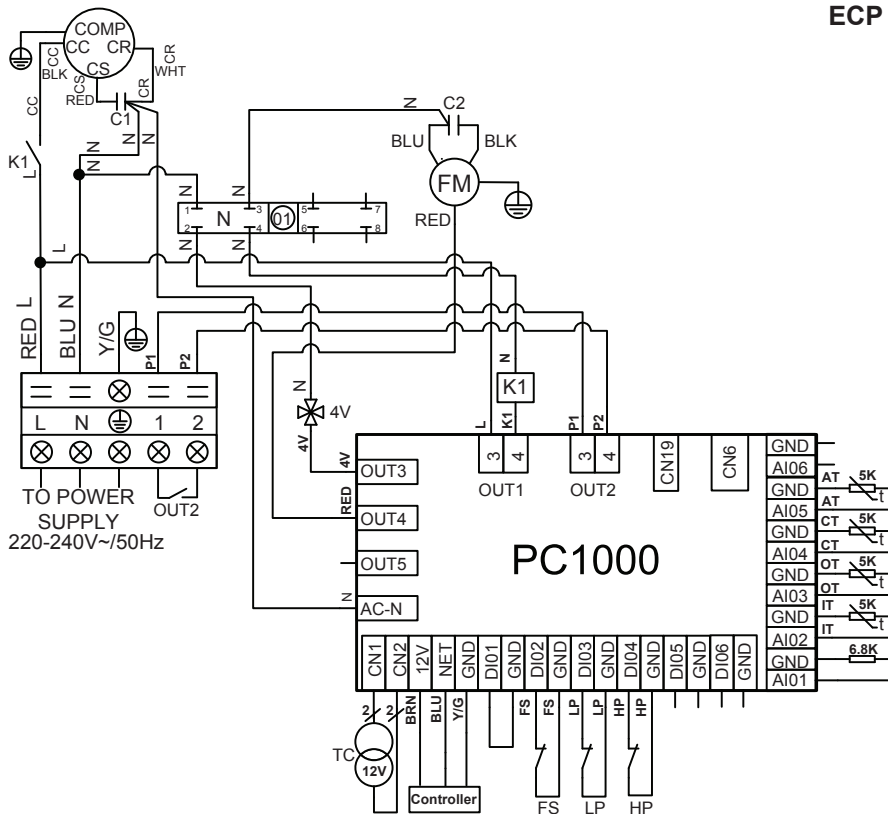

### ANMÄRKNINGAR:

AT: LUFTEMPERATURSOND

COMP: KOMPRESOR

CT: TEMPERATURSOND FÖRÅNGARE

FM: FLÄKTMOTOR

FS: DETEKTOR FÖR VATTENFÖREKOMST

HP: PRESSOSTAT HÖGT TRYCK

IT: TEMPERATURSOND VATTENINLOPP

LP: PRESSOSTAT LÅGT TRYCK

OT: TEMPERATURSOND VATTENUTLOPP

TC: TRANSFORMATOR 230 V~ / 12 V~

4V: FYRVÄGSVENTIL

K1: RELÅ KOMPRESOR

C1: KONDENSATOR KOMPRESOR

C2: KONDESATOR FLÄKT

OUT2 : CONTATTO PULITO LIBERO DA POTENZIALE

7A MAX.



# 6. BILAGOR (fortsättning)

ECP 13

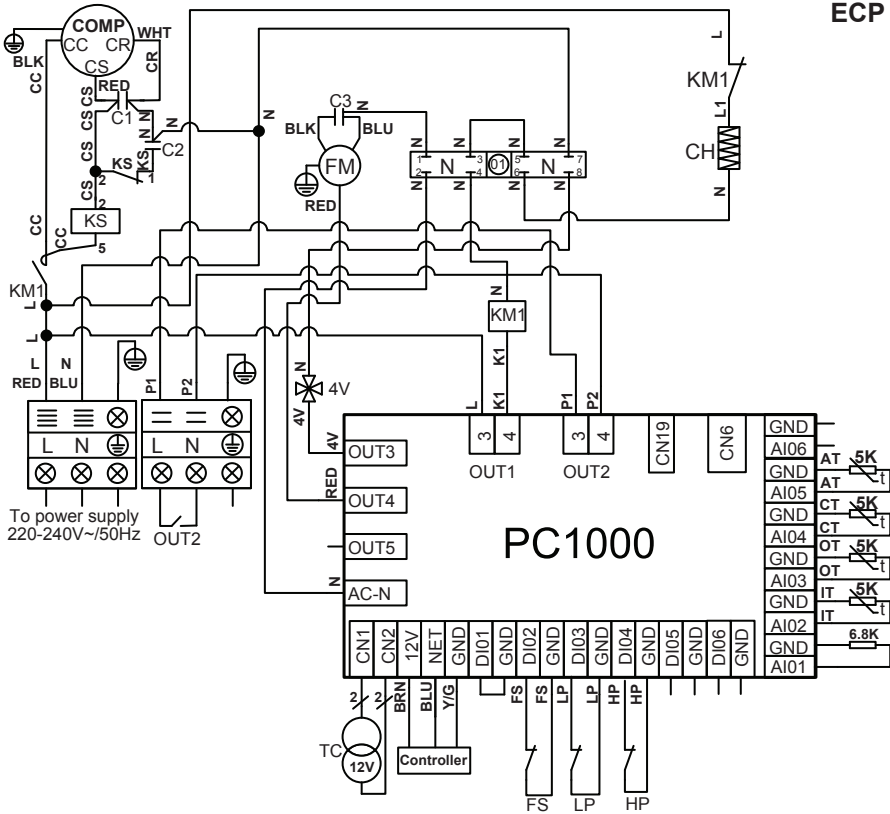

## ANMÄRKNINGAR:

AT: LUFTEMPERATURSOND  
 COMP: KOMPRESOR  
 CH: SKYDDSKÅPANS RESISTANS  
 CT: TEMPERATURSOND FÖRÅNGARE  
 FM: FLÄKTMOTOR  
 FS: DETEKTOR FÖR VATTENFÖREKOMST  
 HP: PRESSOSTAT HÖGT TRYCK  
 IT: TEMPERATURSOND VATTENINLOPP

KS: RELÄSPOLE FÖR START AV KOMPRESSORN  
 LP: PRESSOSTAT LÅGT TRYCK  
 OT: TEMPERATURSOND VATTENUTLOPP  
 TC: TRANSFORMATOR 230 V~ / 12 V~  
 4V: FYRVÄGSVENTIL  
 KM1: KRAFTKONTAKTOR FÖR KOMPRESSOR  
 C1: PERMANENT KONDENSATOR  
 C2: STARTKONDENSATOR  
 OUT2 : CONTATTO PULITO LIBERO DA POTENZIALE  
 7A MAX.

## 6. BILAGOR (fortsättning)

ECP 15

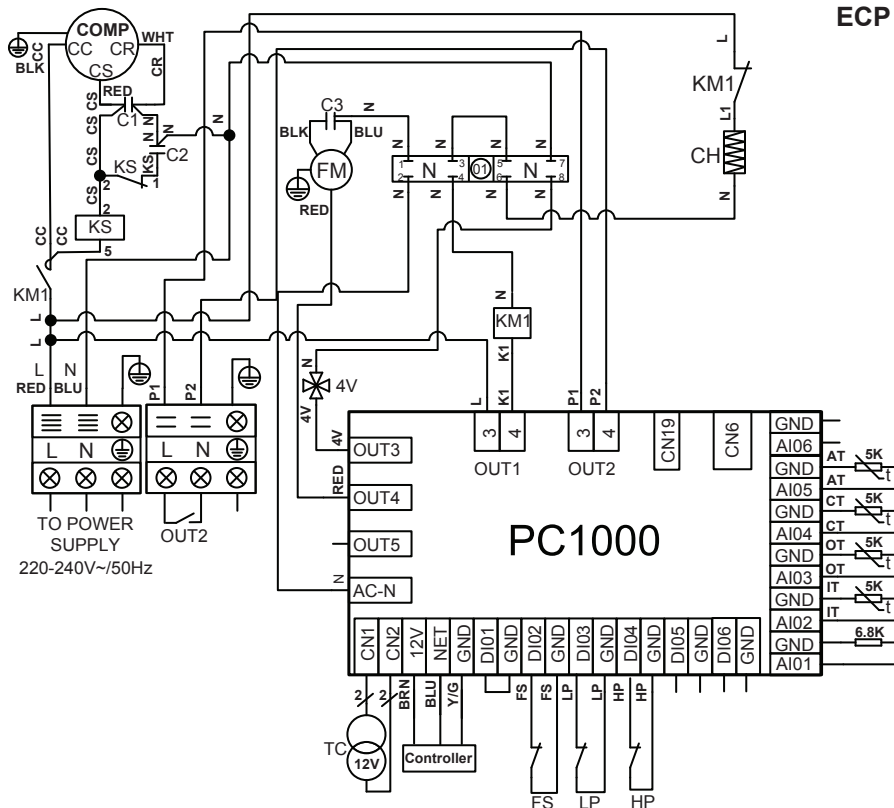

### ANMÄRKNINGAR:

AT: LUFTEMPERATURSOND

COMP: KOMPRESSOR

CH: SKYDDSKÅPANS RESISTANS

CT: TEMPERATURSOND FÖRÅNGARE

FM: FLÄKTMOTOR

FS: DETEKTOR FÖR VATTENFÖREKOMST

HP: PRESSOSTAT HÖGT TRYCK

IT: TEMPERATURSOND VATTENINLOPP

KS: RELÄSPOLE FÖR START AV KOMPRESSORN

LP: PRESSOSTAT LÅGT TRYCK

OT: TEMPERATURSOND VATTENUTLOPP

TC: TRANSFORMATOR 230 V~ / 12 V~

4V: FYRVÄGSVENTIL

KM1: KRAFTKONTAKTOR FÖR KOMPRESSOR

C1: PERMANENT KONDENSATOR

C2: STARTKONDENSATOR

OUT2 : CONTATTO PULITO LIBERO DA POTENZIALE

7A MAX.

## 6. BILAGOR (fortsättning)

### 6.2 Anslutningar prioritet uppvärmning pump enfas

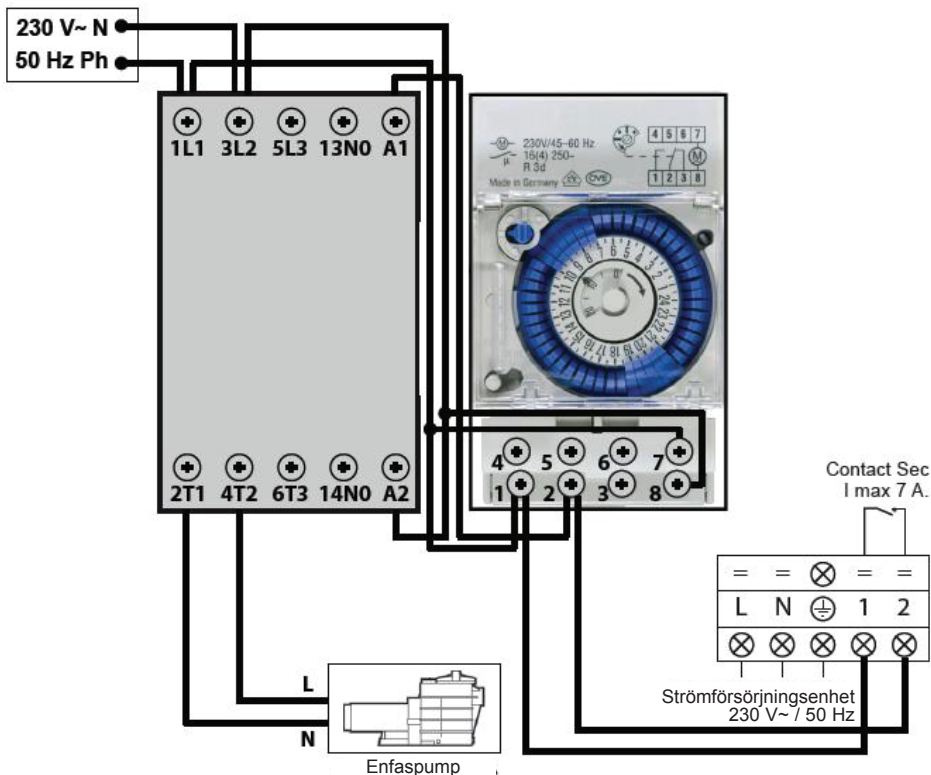

Utanför filtreringsintervallet är det nödvändigt att kontrollera vattentemperaturen genom en regelbunden start av filtreringspumpen (15 minuter varannan timme). Om värmepumpen efterfrågas under denna kontrollperiod kommer denna att starta och att behålla prioritet uppvärmning.



Anslut aldrig strömmen av filtreringspumpen direkt till plint 1 och 2.

## 6. BILAGOR (fortsättning)

### 6.3 Sprängvyer och reservdelar

ECP 06

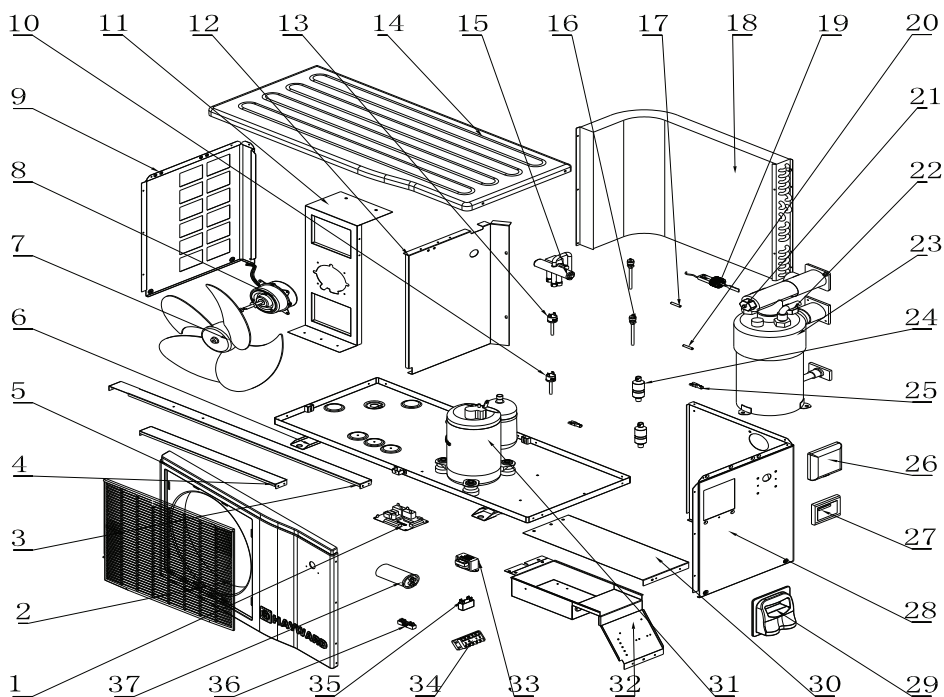

## 6. BILAGOR (fortsättning)

---

### ECP 06

Hänv	Ref.	Beteckning	Hänv	Ref.	Beteckning
1	HWX950531145	Elektroniskt kort PC1000	20	HWX20003242	Temperatursond
2	HWX35252208	Galler	21	HWX20003242	Temperatursond
3	HWX322521062	Bakre spännskruv	22	HWX20003242	Temperatursond
4	HWX322521063	Främre spännskruv	23	HWX32251210	Kondensator av titan/ PVC
5	HWX32025210084	Främre ABS-panel	24	HWX20041444	Filter (Ø9,7-Ø9,7)
6	HWX32025210081	Underrede	25	HWX200014068	Kapilläranslutning
7	HWX34012701	Fläktblad	26	HWX20002111	Skydd för kontrollanordning
8	HWX34013301	Fläktmotor	27	HWX950531188	Kontrollanordning 7 segment
9	HWX32025210083	Panel vänster	28	HWX32025210082	Panel höger
10	HWX20003603	Pressostat lågt tryck	29	HWX32009220054	Handtag
11	HWX322521061	Motorstöd	30	HWX322521064	Panel för elektriskt skydd
12	HWX322521059	Skiljepanel	31	HWX200011006	Kompressor
13	HWX20013605	Pressostat högt tryck	32	HWX322521006	Elskåp
14	HWX32025210085	Övre ABS-panel	33	HWX200037006	Transformator 230 V~/12 V~
15	HWX20011418	Fyrvägsventil	34	HWX40003901	Elektrisk kontakt 5 anslutningar
16	HWX200014153	Shraderventil	35	HWX20003506	Kondensator fläkt 2 µF
17	HWX20003242	Temperatursond	36	HWX20003909	Kontakt 2 anslutningar
18	HWX40001230	Förångare	37	HWX20003504	Kondensator kompressor 35 µF
19	HWX200036005	Flödesdetektor	38	HWX20009910	Kapillär

## 6. BILAGOR (fortsättning)

---

### ECP 08

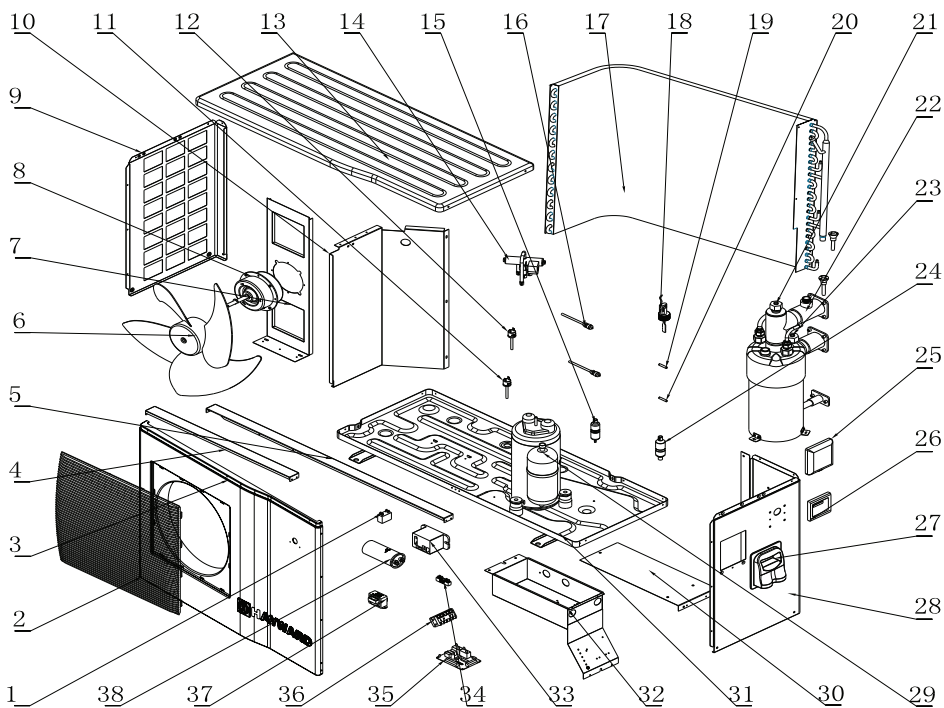



## 6. BILAGOR (fortsättning)

### ECP 08

Hänv	Ref.	Beteckning	Hänv	Ref.	Beteckning
1	HWX20003501	Kondensator fläkt 3 µF	21	HWX20003242	Temperatursond
2	HWX35122213	Galler	22	HWX32081205	Kondensator av titan/ PVC
3	HWX32012210240	Främre ABS-panel	23	HWX20003242	Temperatursond
4	HWX321221175	Främre spännskruv	24	HWX20041445	Filter(Φ9.7-Φ4.2)
5	HWX321221018	Bakre spännskruv	25	HWX20002111	Skydd för kontrollanordning
6	HWX35002701	Fläktblad	26	HWX950531188	Kontrollanordning 7 segment
7	HWX321221174	Motorstöd	27	HWX32009220054	Handtag
8	HWX34043301	Fläktmotor	28	HWX32012210238	Panel höger
9	HWX32012210238	Panel vänster	29	HWX200011135	Kompressor
10	HWX321221173	Skiljepanel	30	HWX321221019	Panel för elektriskt skydd
11	HWX20013605	Pressostat högt tryck	31	HWX32012210237	Underrede
12	HWX20003603	Pressostat lågt tryck	32	HWX321221176	Elskåp
13	HWX32012210241	Övre ABS-panel	33	HWX20003619	Relä
14	HWX20011418	Fyrvägsventil	34	HWX20003909	Kontakt 2 anslutningar
15	HWX20041446	Filter (Ø9,7 - Ø3,4)	35	HWX950531145	Elektroniskt kort PC1000
16	HWX200014153	Shraderventil	36	HWX40003901	Elektrisk kontakt 5 anslutningar
17	HWX34061204	Förångare	37	HWX200037006	Transformator 230 V~/12 V~
18	HWX20003242	Flödesdetektor	38	HWX20003510	Kondensator kompressor 60 µF
19	HWX20003242	Temperatursond	39	HWX20009909	Kapillär
20	HWX20003242	Temperatursond			

## 6. BILAGOR (fortsättning)

---

### ECP 11

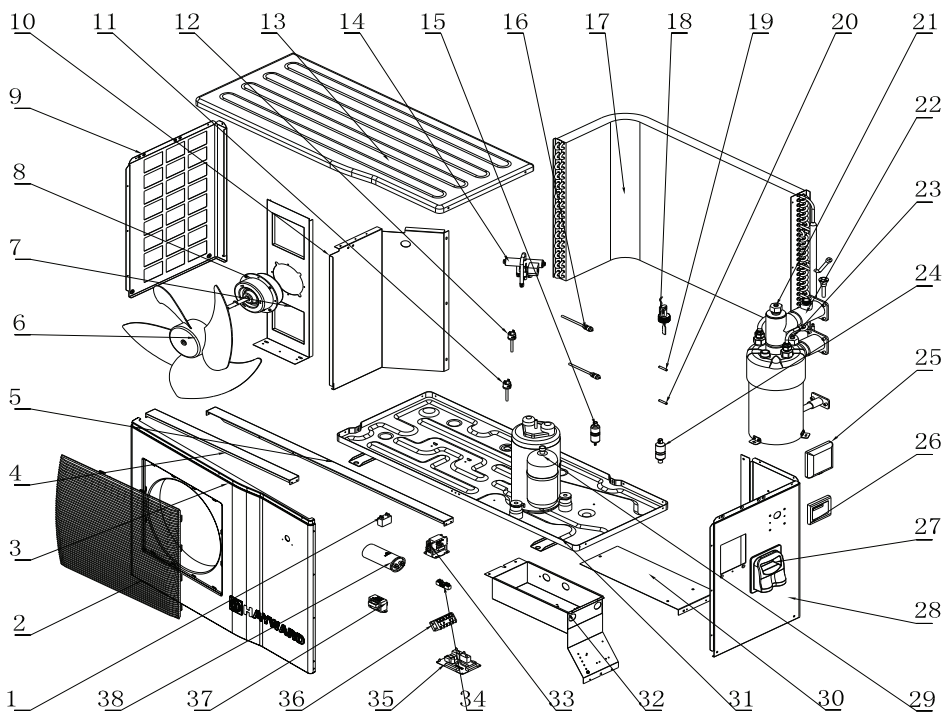

## 6. BILAGOR (fortsättning)

### ECP 11

Hänv	Ref.	Beteckning	Hänv	Ref.	Beteckning
1	HWX20003501	Kondensator fläkt 3 µF	21	HWX20003242	Temperatursond
2	HWX35122213	Galler	22	HWX32121209	Kondensator av titan/ PVC
3	HWX32012210240	Främre ABS-panel	23	HWX20003242	Temperatursond
4	HWX321221175	Främre spännskruv	24	HWX20041445	Filter(Φ9.7-Φ4.2)
5	HWX321221018	Bakre spännskruv	25	HWX20002111	Skydd för kontrollanordning
6	HWX35002701	Fläktblad	26	HWX950531188	Kontrollanordning 7 segment
7	HWX321221174	Motorstöd	27	HWX32009220054	Handtag
8	HWX34043301	Fläktmotor	28	HWX32012210238	Panel höger
9	HWX32012210238	Panel vänster	29	HWX200011134	Kompressor
10	HWX321221173	Skiljepanel	30	HWX321221019	Panel för elektriskt skydd
11	HWX20013605	Pressostat högt tryck	31	HWX32012210237	Underrede
12	HWX20003603	Pressostat lågt tryck	32	HWX321221176	Elskåp
13	HWX32012210241	Övre ABS-panel	33	HWX20003619	Relä
14	HWX20011418	Fyrvägsventil	34	HWX20003909	Kontakt 2 anslutningar
15	HWX20041446	Filter (Ø9,7 - Ø3,4)	35	HWX950531145	Elektroniskt kort PC1000
16	HWX200014153	Shraderventil	36	HWX40003901	Elektrisk kontakt 5 anslutningar
17	HWX321212002	Förångare	37	HWX200037006	Transformator 230 V~/12 V~
18	HWX20003242	Flödesdetektor	38	HWX20003505	Kondensator kompressor 60 µF
19	HWX20003242	Temperatursond	39	HWX20009909	Kapillär
20	HWX20003242	Temperatursond			

## 6. BILAGOR (fortsättning)

---

### ECP 13

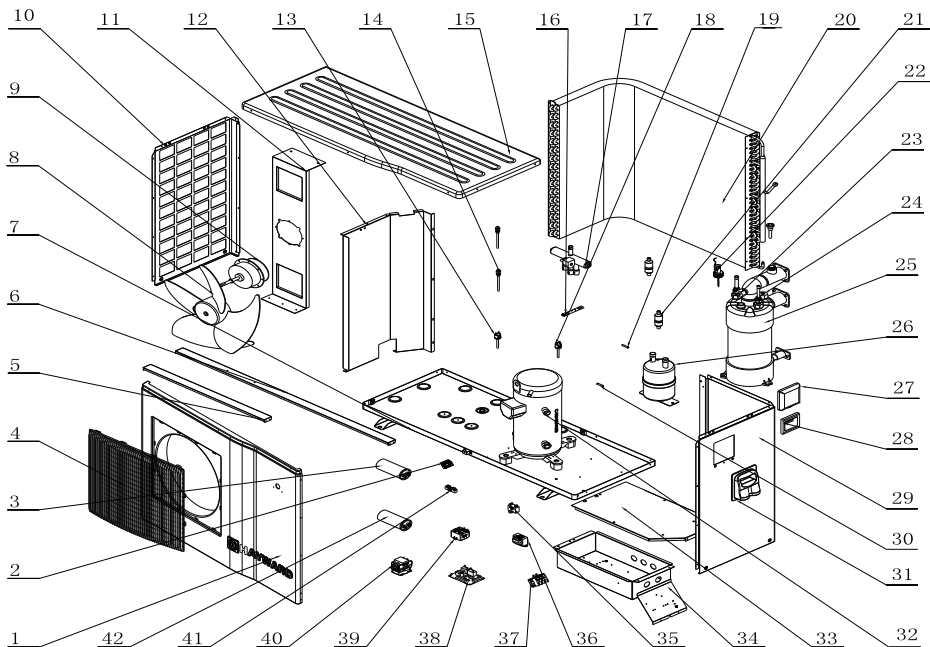

## 6. BILAGOR (fortsättning)

### ECP 13

Hänv	Ref.	Beteckning	Hänv	Ref.	Beteckning
1	HWX32009210196	Främre ABS-panel	23	HWX20003242	Temperatursond
2	HWX20003933	Kontakt 3 anslutningar	24	HWX20003242	Temperatursond
3	HWX20003524	Startkondensator CPS 98 µF	25	HWX32091206	Kondensator av titan/ PVC
4	HWX35122213	Galler	26	HWX35001401	Ackumulator
5	HWX320921015	Främre spännskruv	27	HWX20002111	Skydd för kontrollanordning
6	HWX320921149	Bakre spännskruv	28	HWX950531188	Kontrollanordning 7 segment
7	HWX32009210193	Underrede	29	HWX32009210194	Panel höger
8	HWX35002701	Fläktblad	30	HWX20003242	Temperatursond
9	HWX34043301	Fläktmotor	31	HWX32009220054	Handtag
10	HWX32009210195	Panel vänster	32	HWX20011170	Kompressor
11	HWX320921147	Motorstöd	33	HWX320921152	Panel för elektriskt skydd
12	HWX320921148	Skiljepanel	34	HWX320921151	Elskåp
13	HWX20013605	Pressostat högt tryck	35	HWX20003501	Kondensator fläkt 3 µF
14	HWX200014153	Shraderventil	36	HWX200037006	Transformator 230 V~/12 V~
15	HWX32009210197	Övre ABS-panel	37	HWX20003920	Kontakt 3 anslutningar
16	HWX20001489	Strypventil	38	HWX950531145	Elektroniskt kort PC1000
17	HWX20011491	Fyrvägsventil	39	HWX20003676	Relä
18	HWX20003603	Pressostat lågt tryck	40	HWX200036007	Kontaktor kompressor
19	HWX20003242	Temperatursond	41	HWX20003909	Kontakt 2 anslutningar
20	HWX351212001	Förångare	42	HWX20003510	Kondensator kompressor 60 µF
21	HWX20041444	Filter (Ø9,7-Ø9,7)	43	HWX20009909	Kapillär
22	HWX200036005	Flödesdetektor			

## 6. BILAGOR (fortsättning)

---

ECP 15

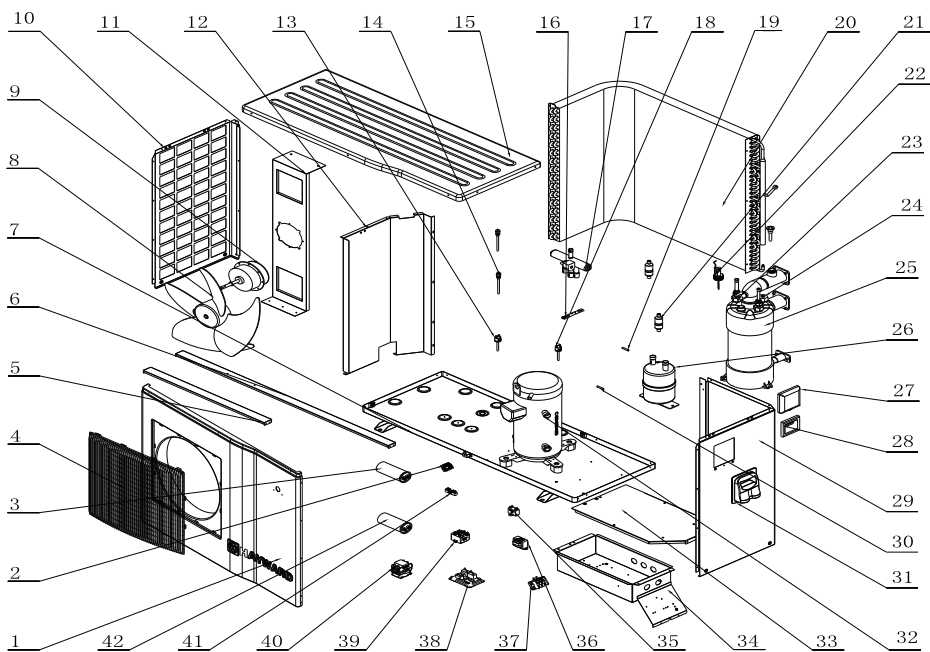

## 6. BILAGOR (fortsättning)

### ECP 15

Hänv	Ref.	Beteckning	Hänv	Ref.	Beteckning
1	HWX32009210196	Främre ABS-panel	23	HWX20003242	Temperatursond
2	HWX20003933	Kontakt 3 anslutningar	24	HWX20003242	Temperatursond
3	HWX20003524	Startkondensator CPS 98 µF	25	HWX32091206	Kondensator av titan/ PVC
4	HWX35122213	Galler	26	HWX35001401	Ackumulator
5	HWX320921015	Främre spännskruv	27	HWX20002111	Skydd för kontrollanordning
6	HWX320921149	Bakre spännskruv	28	HWX950531188	Kontrollanordning 7 segment
7	HWX32009210193	Underrede	29	HWX32009210194	Panel höger
8	HWX35002701	Fläktblad	30	HWX20003242	Temperatursond
9	HWX34043301	Fläktmotor	31	HWX32009220054	Handtag
10	HWX32009210195	Panel vänster	32	HWX20011169	Kompressor
11	HWX320921147	Motorstöd	33	HWX320921152	Panel för elektriskt skydd
12	HWX320921148	Skiljepanel	34	HWX320921151	Elskåp
13	HWX20013605	Pressostat högt tryck	35	HWX20003501	Kondensator fläkt 3 µF
14	HWX200014153	Shraderventil	36	HWX200037006	Transformator 230 V~/12 V~
15	HWX32009210197	Övre ABS-panel	37	HWX20003920	Kontakt 3 anslutningar
16	HWX20001489	Strypventil	38	HWX950531145	Elektroniskt kort PC1000
17	HWX20011491	Fyrvägsventil	39	HWX20003676	Relä
18	HWX20003603	Pressostat lågt tryck	40	HWX200036007	Kontaktor kompressor
19	HWX20003242	Temperatursond	41	HWX20003909	Kontakt 2 anslutningar
20	HWX351212001	Förångare	42	HWX20003510	Kondensator kompressor 60 µF
21	HWX20041444	Filter (Ø9,7-Ø9,7)	43	HWX20009909	Kapillär
22	HWX200036005	Flödesdetektor			

## 6. BILAGOR (fortsättning)

### 6.4 Reparationsvägledning



*Vissa åtgärder får endast vidtas av en behörig tekniker.*

Funktionsfel	Felkoder	Beskrivning	Lösning
Fel på sond för vatteninlopp	P01	Givaren är öppen eller kortsluten.	Kontrollera eller ersätt givaren.
Fel på sond för vattenutlopp	P02	Givaren är öppen eller kortsluten.	Kontrollera eller ersätt givaren.
Fel på sond för yttertemperatur	P04	Givaren är öppen eller kortsluten.	Kontrollera eller ersätt givaren.
Fel på avfrostningssond	P05	Givaren är öppen eller kortsluten.	Kontrollera eller ersätt givaren.
Skydd högt tryck	E01	Trycket i kylkretsen är för högt, eller flödet för lågt, eller förångaren tilltäppt eller luftflödet för lågt.	Kontrollera pressostaten för högt tryck och trycket i kylkretsen. Kontrollera vatten- eller luftflödet. Kontrollera att flödeskontrollenheten fungerar felfritt. Kontrollera öppningen av vatteninloppsventilen/-utloppsventilen. Kontrollera överströmningsventilens inställning.
Skydd lågt tryck	E02	Trycket i kylkretsen är för lågt, eller luftflödet är för lågt eller förångaren är tilltäppt.	Kontrollera pressostaten för lågt tryck och trycket i kylkretsen för att kontrollera om det finns någon läcka. Rengör förångarens yta. Kontrollera fläktens rotationshastighet. Kontrollera att luften kan cirkulera fritt genom förångaren.
Fel på flödesdetektorn.	E03	Vattenflödet är otillräckligt eller detektorn är kortsluten eller defekt.	Kontrollera vattenflödet, kontrollera filtreringspumpen och flödesdetektorn för att se om de uppvisar några eventuella fel.
Temperaturskillnaden mellan vatteninloppet och vattenutloppet är för hög.	E06	Vattenflödet är otillräckligt, vattnets tryckskillnad är för låg/ för hög.	Kontrollera vattenflödet eller om systemet är tilltäppt.
Frostskydd Läge kallt	E07	Mängden utströmmande vatten är för liten.	Kontrollera vattenflödet eller temperaturgivaren för vattenutloppet.
Kommunikationsproblem.	E08	Fel på LED-kontrollanordningen eller på anslutningen till processstyrningsblocket.	Kontrollera kabelanslutningen.
Frostskydd på nivå 1	E19	Omgivningstemperatur och för lite inströmmande vatten.	Stäng av värmepumpen och töm kondensorn. Frostrisk
Frostskydd på nivå 2	E29	Omgivningstemperatur och fortfarande för lite inströmmande vatten.	Stäng av värmepumpen och töm kondensorn. Frostrisk



## 6. BILAGOR (fortsättning)

---

### 6.5 Garanti

#### GARANTIVILLKOR

Alla Haywards produkter omfattas av en garanti mot tillverknings- eller materialfel under en tidsrymd på två år räknat från inköpsdatumet. Alla garantikrav måste åtföljas av ett inköpsbevis som bestyrker detta datum. Vi rekommenderar alltså att du sparar din faktura.

Haywards garanti är begränsad till reparation eller ersättning, enligt Haywards val, av defekta produkter i den mån som de har använts på normalt sätt, i enlighet med föreskrifterna som nämns i bruksanvisningen, produkten inte har ändrats på något sätt och endast använts med Haywards komponenter och delar. Skador som orsakats av frost och kemikalieangrepp täcks inte av garantin. Alla andra avgifter (transport, arbete...) är uteslutna från garantin.

Hayward kommer inte att kunna hållas ansvarigt för någon direkt eller indirekt skada som förorsakats av felaktig installering, anslutning eller drift av produkten.

Ta kontakt med din återförsäljare för att ställa garantikrav och begära reparation eller ersättning av en artikel. Inget återlämnande av materiel till vår fabrik kommer att godtas utan vårt föregående skriftliga medgivande.

Slitdelar omfattas inte av garantin.

# EASY TEMP

ТЕПЛОВОЙ НАСОС ДЛЯ ПЛАВАТЕЛЬНОГО БАССЕЙНА

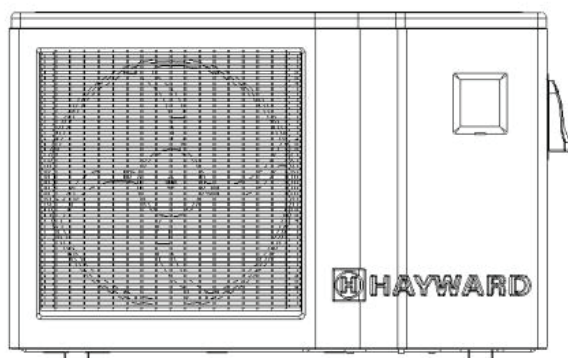

Руководство по монтажу и эксплуатации

# ОГЛАВЛЕНИЕ

---

<b>1. Введение</b>	<b>1</b>
<hr/>	
<b>2. Технические характеристики</b>	<b>2</b>
2.1 Технические данные теплового насоса	2
2.2 Рабочий диапазон	3
2.3 Размеры	4
<hr/>	
<b>3. Установка и подключение</b>	<b>5</b>
3.1 Принципиальная схема	5
3.2 Тепловой насос	5
3.3 Гидротехническое подключение	6
3.4 Электрическое подключение	7
3.5 Первый запуск	8
3.6 Установка пропускной способности насоса	10
<hr/>	
<b>4. Интерфейс пользователя</b>	<b>11</b>
4.1 Общие сведения	11
4.2 Установка времени	13
4.3 Настройка функции таймер	13
4.4 Выбор режима работы: подогрев или охлаждение	14
4.5 Установка и визуализация заданного значения	15
4.6 Блокировка и разблокировка интерфейса пользователя	15
<hr/>	
<b>5. Техническое обслуживание и консервация на зиму</b>	<b>16</b>
5.1 Техническое обслуживание	16
5.2 Консервация на зиму	16
<hr/>	
<b>6. Приложения</b>	<b>17</b>
6.1 Электрические схемы	17
6.2 Включение подогрева в качестве приоритета	22
6.3 Вид в разборе и съемные элементы	23
6.4 Справочник по устранению неисправностей	33
6.5 Гарантия	34

Внимательно прочитать и сохранить для дальнейших консультаций.

Этот документ необходимо передать владельцу плавательного бассейна, чтобы он его сохранил в надежном месте.

## 1. ВВЕДЕНИЕ

---

Благодарим Вас за приобретение данного теплового насоса для плавательного бассейна Easy Temp. Данное изделие разработано в соответствии со строгими производственными стандартами для удовлетворения предъявляемых требований по качеству. Данное изделие включает в себя всю информацию, необходимую для установки изделия, устранения неисправностей и его технического обслуживания. Перед тем как распаковать изделие или перед выполнением его технического обслуживания, внимательно ознакомьтесь с данным руководством. Производитель данного изделия не несет никакой ответственности за причинение травм потребителю или повреждение изделия вследствие его неправильной установки, за устранение нарушений в работе или бесполезное техническое обслуживание. Крайне важно всегда следовать инструкциям, изложенным в данном руководстве. Устройство должно быть установлено силами квалифицированного персонала.

- Ремонт должен осуществляться силами квалифицированного персонала.
- Все операции по электрическому подключению должны осуществляться квалифицированным электриком-профессионалом и в соответствии с нормами, действующими в стране, где производится установка см. § 3.4.
- Техническое обслуживание и необходимые процедуры должны осуществляться с частотой и в сроки, определенные в настоящем руководстве.
- Используйте только оригинальные запасные части.
- Несоблюдение данных рекомендаций ведет к отмене гарантийных обязательств.
- Данный тепловой насос нагревает воду в плавательном бассейне, поддерживает постоянную температуру и не предназначен для использования в других целях.

После прочтения данного руководства держите его под рукой для дальнейшего использования.

Замечания относительно детей/людей с ограниченными физическими возможностями:

Данное изделие не предназначено для использования лицами (особенно детьми), физические, сенсорные или умственные способности которых ограничены, или лицами, не имеющими необходимого опыта или знаний, если только они не совершают этого под присмотром или не получили инструкции касательно использования изделия от лица, несущего за них ответственность.

Данное изделие содержит фторсодержащие газы, вызывающие парниковый эффект, применение которых оговорено в Киотском протоколе.

Тип хладагента: R410A

Значение в рамках потенциала глобального потепления<sup>(1)</sup>: 1975

В рамках европейского или местного законодательства могут проводиться периодические проверки на предмет возможной утечки хладагента. Для получения дополнительной информации обращайтесь к Вашему местному дистрибьютору.

---

(1) Возможность глобального потепления

## 2. ТЕХНИЧЕСКИЕ ХАРАКТЕРИСТИКИ

### 2.1 Технические данные теплового насоса

Модель	EASY TEMP	ЕСР 06	ЕСР 08	ЕСР 11	ЕСР 13	ЕСР 15
Тепловая производительность *	кВт британских тепловых единиц/час	5,5 18785	8 27322	11 37566	13.5 46105	15 51228
Потребляемая электрическая мощность	кВт	1,17	1,8	2,43	3	3,13
Рабочий ток *	А	5,19	7,91	11,81	14,5	16
Электропитание	V pH/Hz	230 В ~ 1/50 Hz	230 В ~ 1/50 Hz	230 В ~ 1/50 Hz	230 В ~ 1/50 Hz	230 В ~ 1/50 Hz
Номинал предохранителя, тип aM	А	8 aM	10 aM	16 aM	20 aM	20 aM
Автоматический выключатель, кривая D	А	8 D	10 D	16 D	20 D	20 D
Количество компрессоров		1	1	1	1	1
Тип компрессора		Ротационный	Ротационный	Ротационный	Улитка	Улитка
Количество вентиляторов		1	1	1	1	1
Мощность вентилятора	W	50	120	120	120	120
Скорость вращения вентилятора	об/мин	770	850	850	850	850
Вентиляция		Горизонтальная	Горизонтальная	Горизонтальная	Горизонтальная	Горизонтальная
Уровень акустического давления (на 1 метр)	дБ(А)	47	51	54	56	56
Гидротехническое подключение	мм	50	50	50	50	50
Номинальная пропускная способность	м³/час	2,3	3,0	4,5	5,3	6,6
Снижения давления воды (макс.)	кПа	5,4	8,9	19,2	5,2	39,9
Чистые размеры устройства (Длина/ширина/высота)	мм	895/375/545	1035/415/650	1035/415/650	1136/440/870	1136/440/870
Размеры устройства в упаковке (Длина/ширина/высота)	мм	970/430/710	1120/480/810	1180/480/810	1230/510/1020	1230/510/1020
Вес нетто/вес брутто устройства	кг	45/56	54/68	60/74	95/115	117/128

\* Значение при +/- 5% при следующих условиях: Температура окружающей среды = 24 °C (75 °F)/Относительная влажность = 62%/Температура воды в бассейне = 27 °C (80 °F)



## 2. ТЕХНИЧЕСКИЕ ХАРАКТЕРИСТИКИ

### (продолжение)

---

#### 2.2 Рабочий диапазон

Для обеспечения надежной и эффективной работы теплового насоса используйте его в следующих рабочих диапазонах температур и влажности.

	Режим подогрева 	Режим Охлаждение 
Температура окружающей среды	+2 °C ~ +35 °C	+7 °C ~ +43 °C
Температура воды	+12 °C ~ +40 °C	+8 °C ~ +40 °C
Относительная влажность	< 80%	< 80%
Рабочий диапазон заданного значения	+15 °C ~ +40 °C	+8 °C ~ +35 °C



**Если температура или влажность не соответствуют указанным условиям, может сработать защитное устройство, и тогда тепловой насос может отключиться.**

## 2. ТЕХНИЧЕСКИЕ ХАРАКТЕРИСТИКИ (продолжение)

### 2.3 Размеры

Модели: ECP06 / ECP08 / ECP11 / ECP13 / ECP15

Вид спереди

Вид сзади

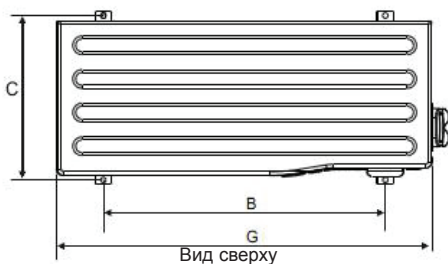
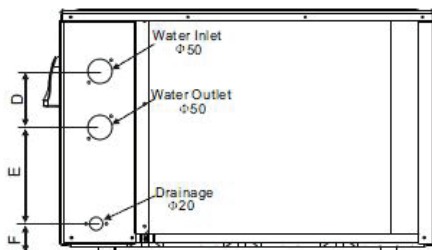

Устройство: мм

Модель / Позиция	ECP06	ECP08 ECP11	ECP13 ECP15
<b>A</b>	540	648	866
<b>B</b>	571	755	840
<b>C</b>	400	440	470
<b>D</b>	140	150	150
<b>E</b>	258	258	330
<b>F</b>	66	77	80
<b>G</b>	860	1004	1114

## 3. УСТАНОВКА И ПОДКЛЮЧЕНИЕ

### 3.1 Принципиальная схема

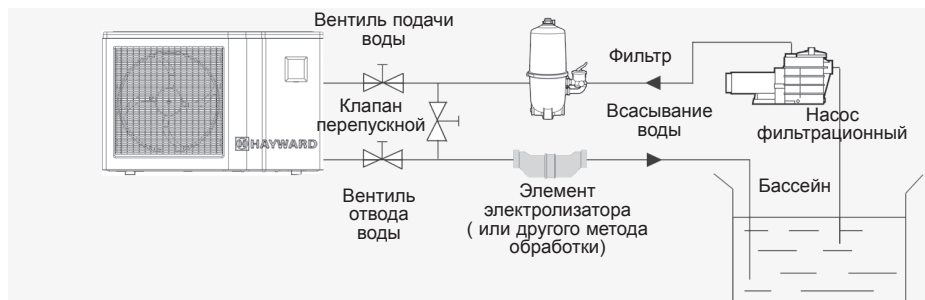

Примечание. Тепловой насос поставляется без какого-либо дополнительного оборудования для обработки или фильтрации воды. Представленные на схеме элементы поставляются фирмой, осуществляющей установку.

### 3.2 Тепловой насос



**Разместите тепловой насос на открытом воздухе, отдельно от любого другого закрытого оборудования.**

**Разместите его под навесом, с соблюдением всех указанных минимальных расстояний до других предметов, чтобы избежать всех рисков, связанных с рециркуляцией воздуха и возможного отрицательного влияния теплового насоса на состояние окружающей среды.**

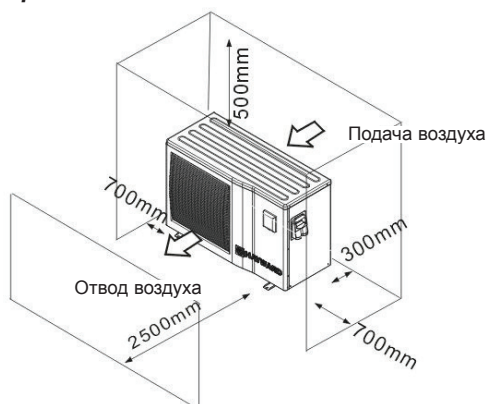



### 3. УСТАНОВКА И ПОДКЛЮЧЕНИЕ (продолжение)



*Желательно установить тепловой насос на отдельной бетонной площадке или в другом предусмотренном для этого месте, с использованием входящих в комплект поставки сайлентблоков (болты и шайбы в комплект поставки не входят).*

*Максимальное расстояние между тепловым насосом и плавательным бассейном не должно превышать 15 м.*

*Общая длина шлангов подачи и отвода воды не должна превышать 30 метров.*

*Изолируйте шланги от поверхности земли и не закапывайте.*

#### 3.3 Гидротехническое подключение

Тепловой насос поставляется с двумя штуцерными соединениями диаметром 50 мм с накидной гайкой. Для подвода воды используйте ПВХ шланги Ø 50 мм. Соедините входное отверстие для воды теплового насоса со шлангом, ведущим к фильтрационному блоку, затем соедините выходное отверстие для воды теплового насоса со шлангом, подающим воду в бассейн (см. приведенную ниже схему).

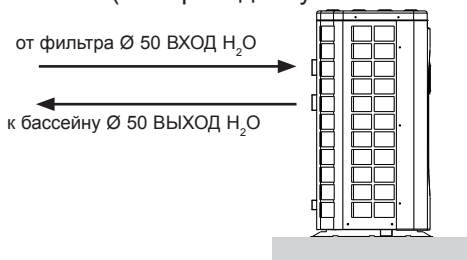

Установите так называемый «перепускной» клапан между входным и выходным отверстиями теплового насоса.



*Если используется автоматическое питательное устройство или электризатор, они должны быть установлены непосредственно после теплового насоса с целью предохранения конденсатора Titape от чрезмерного накопления в нем химических продуктов.*



*Постарайтесь установить перепускной клапан и поставляемые штуцерные соединения на одном уровне с входом и выходом воды на устройстве, чтобы упростить слив воды на зимний период, облегчив таким образом доступ к элементам и демонтаж на период технического обслуживания.*

### 3. УСТАНОВКА И ПОДКЛЮЧЕНИЕ (продолжение)

#### 3.4 Электрическое подключение



**Электроподключение и все соединения данного оборудования должны соответствовать местным действующим правилам установки.**

F	NF C15-100	GB	BS7671:1992
D	DIN VDE 0100-702	EW	EVHS-HD 384-7-702
A	ÖVE 8001-4-702	H	MSZ 2364-702/1994/MSZ 10-553 1/1990
E	UNE 20460-7-702 1993, RECBT ITC-BT-31 2002	M	MSA HD 384-7-702.S2
IRL	Wiring Rules + IS HD 384-7-702	PL	PN-IEC 60364-7-702:1999
I	CEI 64-8/7	CZ	CSN 33 2000 7-702
LUX	384-7.702 S2	SK	STN 33 2000-7-702
NL	NEN 1010-7-702	SLO	SIST HD 384-7-702.S2
P	RSIUEE	TR	TS IEC 60364-7-702



**Убедитесь, что имеющееся в наличии электропитание и частота соответствуют требуемым параметрам тока, приняв во внимание специфическую установку прибора и потребности всех других устройств, подключенных к данной цепи.**

**ЕСР 06 230 В~ +/- 10 % 50 Гц 1 Фаза**

**ЕСР 08 230 В~ +/- 10 % 50 Гц 1 Фаза**

**ЕСР 11 230 В~ +/- 10 % 50 Гц 1 Фаза**

**ЕСР 13 230 В~ +/- 10 % 50 Гц 1 Фаза**

**ЕСР 15 230 В~ +/- 10 % 50 Гц 1 Фаза**

**Соблюдайте требования соответствующей схемы соединений в приложении.**

**Соединительная коробка находится с правой стороны устройства. Три контактных соединения предназначены для подключения электропитания, два других — для подключения механизма управления фильтрационного насоса (Системы автоматического управления).**

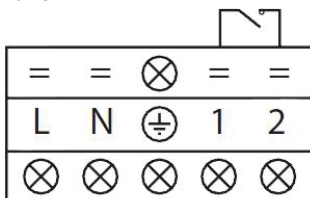

Основное питание  
230 В~/50 Гц

См. 7А Макс.

### 3. УСТАНОВКА И ПОДКЛЮЧЕНИЕ (продолжение)



*Цепь электропитания должна быть снабжена соответствующим защитным устройством (предохранителем для защиты электродвигателей и кабелей типа aM) или автоматическим выключателем (кривая B), а также дифференциальным автоматом на 30 мА (см. следующую страницу).*

Модели		ЕСР 06	ЕСР 08	ЕСР 11	ЕСР 13	ЕСР 15
Электропитание	В/Ф/Гц	230 В~ 1/50 Гц	230 В~ 1/50 Гц	230 В~ 1/50 Гц	230 В~ 1/50 Гц	230 В~ 1/50 Гц
Номинал предохранителя, тип aM	A	8 aM	10 aM	16 aM	20 aM	20 aM
Автоматический выключатель кривая D	A	8 D	10 D	16 D	20 D	20 D



*Перед открытие блока электроуправления всегда отключайте источник основного питания.*

#### 3.5 Первый запуск

Процедура запуска — после того как закончена установка, неуклонно следуйте следующему порядку действий:

- 1) Проверните вентилятор рукой, чтобы убедиться в том, что он свободно вращается, и что винт правильно закреплен на валу мотора.
- 2) Убедитесь в том, что устройство правильно подключено к источнику основного питания (см. схему соединения в приложении).
- 3) Включите фильтрационный насос.
- 4) Перед тем как перейти к режимам подогрева или охлаждения, проверьте, чтобы все вентили были открыты и чтобы вода поступала в устройство.
- 5) Проверьте, чтобы трубка слива конденсата была правильно установлена, чтобы не создавалось никаких помех.
- 6) Включите электропитание устройства, затем нажмите кнопку Пуск/Стоп  на панели управления.

### **3. УСТАНОВКА И ПОДКЛЮЧЕНИЕ (продолжение)**

---

- 7) Убедитесь в том, что в то время, когда устройство находится в режиме ВКЛ, не горит ни один код ТРЕВОГИ (см. справочник по устранению неисправностей).
- 8) Установите пропускную способность для воды с помощью перепускного клапана (см. § 3.6 и 2.1) на уровне, предусмотренном для соответствующей модели, так, чтобы разница температур воды на входе/выходе составляла 2 °С.
- 9) После нескольких минут работы проверьте, чтобы температура воздуха, выходящего из устройства, понизилась (была между 5 и 10°).
- 10) Не выключая устройства, остановите фильтрационный насос. Устройство должно автоматически отключиться и показать код ошибки E03.
- 11) Оставьте устройство и насос плавательного бассейна включенными круглосуточно, пока температура воды не достигнет желаемого уровня. Когда температура воды на входе достигнет заданного значения, устройство отключится. Оно снова самостоятельно включится (при условии, чтоб будет включен насос плавательного бассейна), если температура в плавательном бассейне понизится хотя бы на 0,5 °С от заданной.

**Контроллер пропускной способности** — Устройство снабжено контроллером пропускной способности, который включает тепловой насос при включенном фильтрационном насосе плавательного бассейна, и отключает тепловой насос при неработающем фильтрационном насосе. При отсутствии поступления воды на экране регулятора загорается код ошибки E03 (См. § 6.4).

**Задержка** — устройство работает с задержкой в 3 минуты с целью защиты компонентов управляющей цепи, устранения любой нестабильности при повторном запуске и всех помех в цепи контактора. Благодаря данной задержке устройство автоматически включается примерно через 3 минуты после полного отключения управляющей цепи. Таким же образом кратковременное отключение тока активизирует цепь

### 3. УСТАНОВКА И ПОДКЛЮЧЕНИЕ (продолжение)

задержки включения.

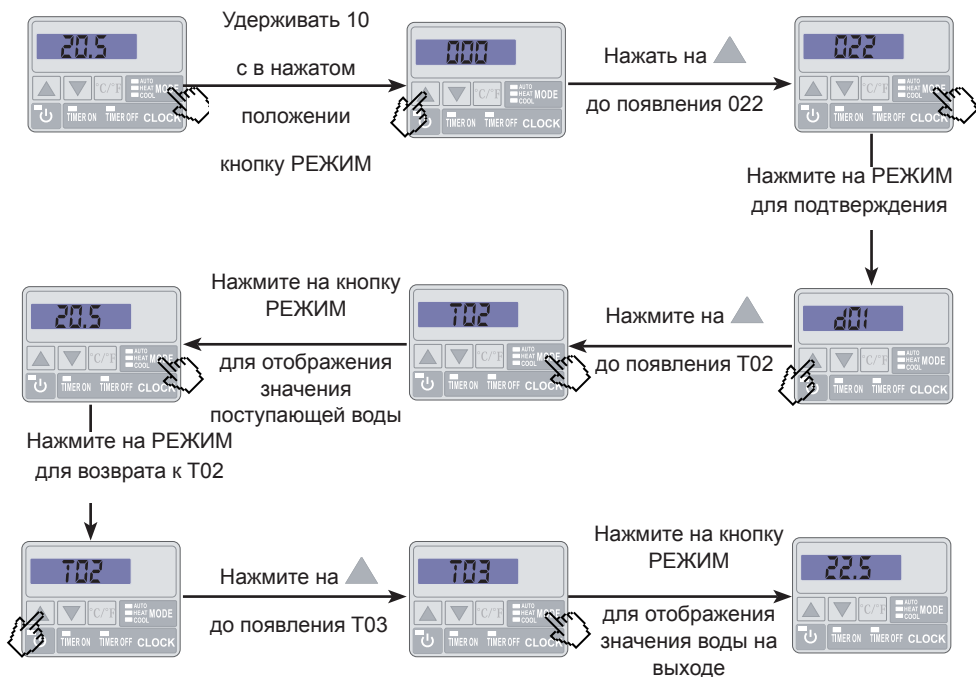

#### 3.6 Установка пропускной способности насоса

Открыв вентили входа и выхода воды, отрегулируйте так называемый «перепускной» клапан так, чтобы разница между температурами воды на входе и выходе составляла 2 °С (см. § 3.1 принципиальной схемы). Вы можете проверить правильность регулировки, контролируя отображаемые на командной панели значения температур воды на входе (T02) и выходе (T03).

Затем произведите установку перепускного клапана так, чтобы получить разницу в 2 °С между T03 и T02 ( $T03 - T02 = \Delta T = 2$ ).

Нажмите 2 раза на , чтобы выйти из меню

Примечание. Открытие так называемого «перепускного» клапана понижает влияние пропускной способности на повышение разницы температур  $\Delta T$ .  
Закрытие так называемого «перепускного» клапана повышает влияние пропускной способности на понижение разницы температур  $\Delta T$ .

## 4. ИНТЕРФЕЙС ПОЛЬЗОВАТЕЛЯ







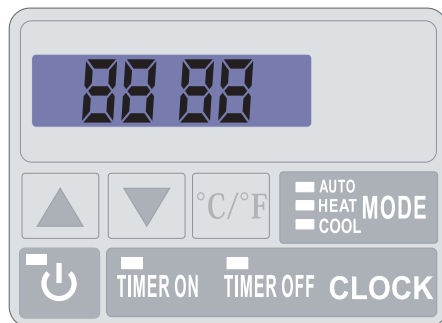



---

### 4.1 Общие сведения

Тепловой насос оборудован электронной панелью управления, соединенной электрически с устройством и настроенным на заводе на режим подогрева.



#### Условные обозначения

-  Символ Режим Охлаждения
-  Символ Режим Подогрева
-  Автоматический режим
-  Установка времени и Таймера
-  Кнопка выбора и установки
-  Кнопка Пуск/Стоп и возврат
-  Переход вниз
-  Переход вверх
-  Установка времени работы
-  Установка времени остановки

## 4. ИНТЕРФЕЙС ПОЛЬЗОВАТЕЛЯ (продолжение)

### Режим ВЫКЛ

Когда тепловой насос находится в спящем режиме (Режим ВЫКЛ), на экране регулятора видно время и режим работы.

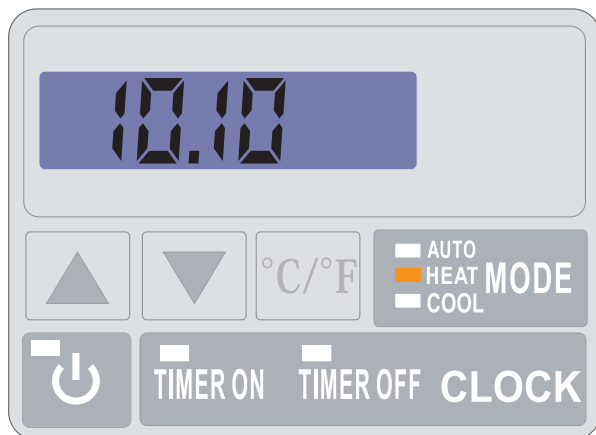

### Режим ВКЛ



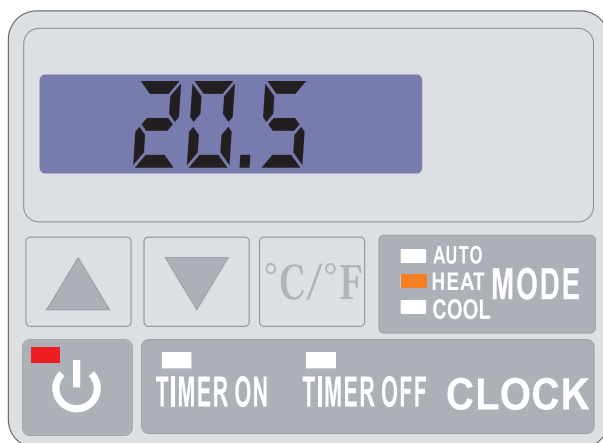

Когда тепловой насос находится в рабочем или регулировочном режиме (Режим ВКЛ), включен светящийся индикатор кнопки пуска красного цвета и на экране отображается температура воды на входе.



## 4. ИНТЕРФЕЙС ПОЛЬЗОВАТЕЛЯ (продолжение)

---

### 4.2 Установка времени





Регулировка времени может производиться в режиме ВКЛ и ВЫКЛ. Нажмите «CLOCK» (ЧАСЫ), показания времени начнут мигать, затем нажмите на «CLOCK», начнет мигать индикация часов. Установите правильное показания часов с помощью стрелок  или  затем нажмите еще раз «CLOCK», чтобы выбрать показания минут. Установите минуты с помощью стрелок  или . Нажмите «CLOCK» для подтверждения. Индикатор вернется в свое предыдущее состояние.

Примечание. Установки автоматически сохраняются, если ни одна из кнопок не нажата в течение 5 секунд, в противном случае нажмите кнопку «CLOCK».

### 4.3 Настройка функции таймер





Установка этой функции нужна в том случае, если необходимо, чтобы тепловой насос работал в течение более короткого периода времени по сравнению с установленным временем фильтрации. Вы также можете запрограммировать произвольное время включения и выключения или просто отключить временной рабочий диапазон (например, ночью).

#### Программирование Время начала работы (Таймер ВКЛ)/Пуск

- 1) Нажмите «Таймер ВКЛ», замигает индикация часов.
- 2) Нажмите «Таймер ВКЛ», чтобы установить показания часов с помощью кнопок  .
- 3) Нажмите «Таймер ВКЛ», чтобы установить значения минут с помощью кнопок  .

Установки автоматически сохраняются, если ни одна из кнопок не нажата в течение 5 секунд, в противном случае нажмите кнопку «Таймер ВКЛ» Зеленый индикатор указывает на то, что таймер активирован.

#### Программирование Окончание работы (Таймер ВЫКЛ)/Стоп

- 1) Нажать «Таймер ВЫКЛ», замигает индикация часов.
- 2) Нажать «Таймер ВЫКЛ», чтобы установить показания часов с помощью кнопок  .
- 3) Нажать «Таймер ВЫКЛ», чтобы установить показания минут с помощью кнопок  .



Установки автоматически сохраняются, если ни одна из кнопок не нажата в течение 5 секунд, в противном случае нажмите кнопку «Таймер ВКЛ». Красный индикатор указывает на то, что таймер активирован.



## 4. ИНТЕРФЕЙС ПОЛЬЗОВАТЕЛЯ (продолжение)

---

### Отмена показаний Таймера (Таймер ВКЛ и ВЫКЛ)/Стоп и Пуск

- 1) Нажмите «Таймер ВКЛ», «Таймер ВКЛ» начнет мигать.
- 2) Нажмите  для отмены запрограммированных значений.
- 3) Нажмите «Таймер ВЫКЛ», «Таймер ВЫКЛ» начнет мигать.
- 4) Нажмите  для отмены запрограммированных значений.

### 4.4 Выбор режима работы: нагревание, охлаждение или автоматический режим.

#### В режиме «ВЫКЛ» или «ВКЛ»

Нажмите кнопку «РЕЖИМ», чтобы переключиться из режима охлаждения (зеленый индикатор) в режим нагрева (оранжевый индикатор) в автоматический режим (красный индикатор).

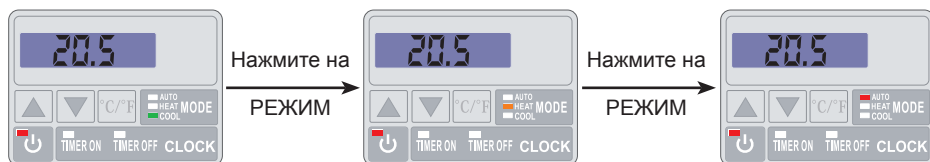



## 4. ИНТЕРФЕЙС ПОЛЬЗОВАТЕЛЯ (продолжение)

---



### 4.5 Установка и визуализация заданного значения (Желаемая температура воды)

В режиме «ВЫКЛ» и режиме «ВКЛ»

Нажать кнопки  или  для установки желаемого заданного значения. Установка возможна с шагом 0,5 °С.



*Чтобы избежать деформации жаровых трубок, рекомендуется никогда не превышать температуру 30 °С.*

Примечание. В режиме работы или остановки достаточно нажать кнопку  или  , чтобы увидеть или изменить заданное значение.

### 4.6 Блокировка и разблокировка тактильного экрана

Нажмите кнопку Пуск/Стоп  на 5 с, пока не раздастся звуковой сигнал. Клавиши становятся неактивными.

Для разблокировки нажать  на 5 с, пока не раздастся звуковой сигнал.

Клавиши вновь становятся активными.

## 5. ТЕХНИЧЕСКОЕ ОБСЛУЖИВАНИЕ И КОНСЕРВАЦИЯ НА ЗИМУ

---

### 5.1 Техническое обслуживание

Для гарантирования продолжительной и надежной работы теплового насоса рекомендуется 1 раз в год проводить следующие операции по обслуживанию устройства.

- Очистите испаритель с помощью мягкой щетки или воздушной/водяной струи (**Внимание! Никогда не используйте для очистки высокое давление**).
- Проверьте, что конденсат хорошо стекает.
- Проверьте надежность гидротехнических и электрических соединений



***Перед производством любых работ по техническому обслуживанию теплового насоса необходимо отсоединить его от источника питания. Все операции по техническому обслуживанию должны производиться только специально подготовленным персоналом, имеющим опыт работы с жидкими хладагентами.***

- Проверьте гидравлическую герметичность конденсатора.

### 5.2 Консервация на зиму

- Переведите тепловой насос в режим «ВЫКЛ»
- Отключите тепловой насос от источника питания.
- Слейте содержимое конденсатора для предотвращения риска повреждения. (Риск возможного замерзания).
- Закройте «перепускной» клапан и отсоедините штуцерные соединения входа/выхода.
- С помощью пистолета высокого давления максимально выдуйте остатки воды из охладителя.
- Перекройте вход и выход для воды теплового насоса для предотвращения попадания туда инородных тел.
- Укройте тепловой насос предназначенным для этих целей зимним чехлом.



***Любые неполадки, вызванные неправильной консервацией на зимний период, аннулируют гарантию.***

## 6. ПРИЛОЖЕНИЯ

### 6.1 Электрические схемы

ECP 06

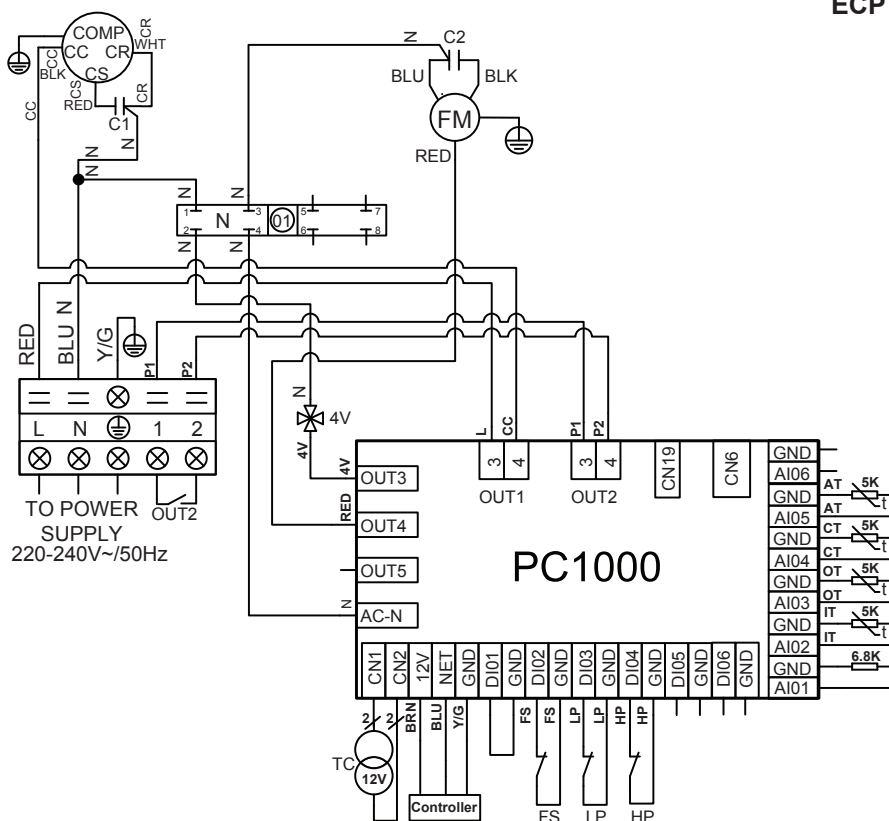

#### ПРИМЕЧАНИЯ:

AT: ДАТЧИК ТЕМПЕРАТУРЫ ВОЗДУХА  
 COMP: КОМПРЕССОР  
 CT: ДАТЧИК ТЕМПЕРАТУРЫ ИСПАРИТЕЛЯ  
 FM: МОТОР ВЕНТИЛЯТОРА  
 FS: ДЕТЕКТОР НАЛИЧИЯ ВОДЫ  
 HP: РЕЛЕ ВЫСОКОГО ДАВЛЕНИЯ  
 IT: ДАТЧИК ТЕМПЕРАТУРА ВОДЫ НА ВХОДЕ

LP: РЕЛЕ НИЗКОГО ДАВЛЕНИЯ  
 OT: ДАТЧИК ТЕМПЕРАТУРА ВОДЫ НА ВЫХОДЕ  
 TC: ТРАНСФОРМАТОР 230 В~/12 В~  
 4V: ЧЕТЫРЕХХОДОВОЙ КЛАПАН  
 C1: КОНДЕНСАТОР КОМПРЕССОРА  
 C2: КОНДЕНСАТОР ВЕНТИЛЯТОРА  
 OUT2 : СВОБОДНЫЙ КОНТАКТ С МАКСИМАЛЬНЫМ  
 ПОТЕНЦИАЛОМ 7А



## 6. ПРИЛОЖЕНИЯ (продолжения)

ECP 11

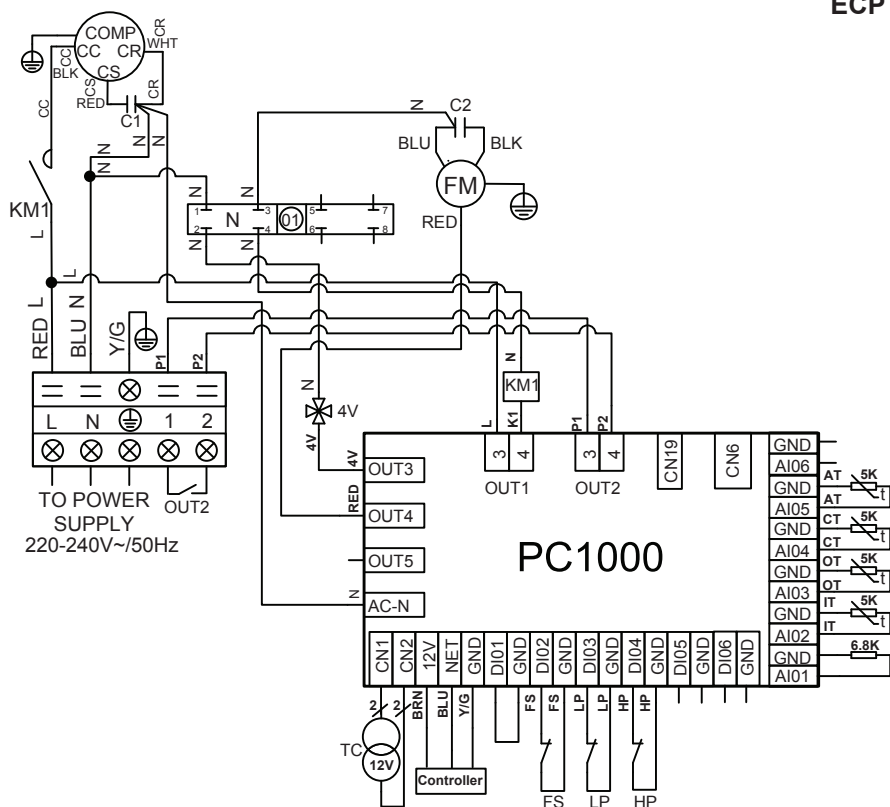

### ПРИМЕЧАНИЯ:

AT: ДАТЧИК ТЕМПЕРАТУРЫ ВОЗДУХА  
 COMP: КОМПРЕССОР  
 CT: ДАТЧИК ТЕМПЕРАТУРЫ ИСПАРИТЕЛЯ  
 FM: МОТОР ВЕНТИЛЯТОРА  
 FS: ДЕТЕКТОР НАЛИЧИЯ ВОДЫ  
 HP: РЕЛЕ ВЫСОКОГО ДАВЛЕНИЯ  
 IT: ДАТЧИК ТЕМПЕРАТУРА ВОДЫ НА ВХОДЕ

LP: РЕЛЕ НИЗКОГО ДАВЛЕНИЯ  
 OT: ДАТЧИК ТЕМПЕРАТУРА ВОДЫ НА ВЫХОДЕ  
 TC: ТРАНСФОРМАТОР 230 В~/12 В~  
 4V: ЧЕТЫРЕХХОДОВОЙ КЛАПАН  
 KM1: КОНТАКТОР МОЩНОСТИ КОМПРЕССОРА  
 C1: КОНДЕНСАТОР КОМПРЕССОРА  
 C2: КОНДЕНСАТОР ВЕНТИЛЯТОРА  
 OUT2 : СВОБОДНЫЙ КОНТАКТ С МАКСИМАЛЬНЫМ ПОТЕНЦИАЛОМ 7А

## 6. ПРИЛОЖЕНИЯ (продолжения)

ECP 13

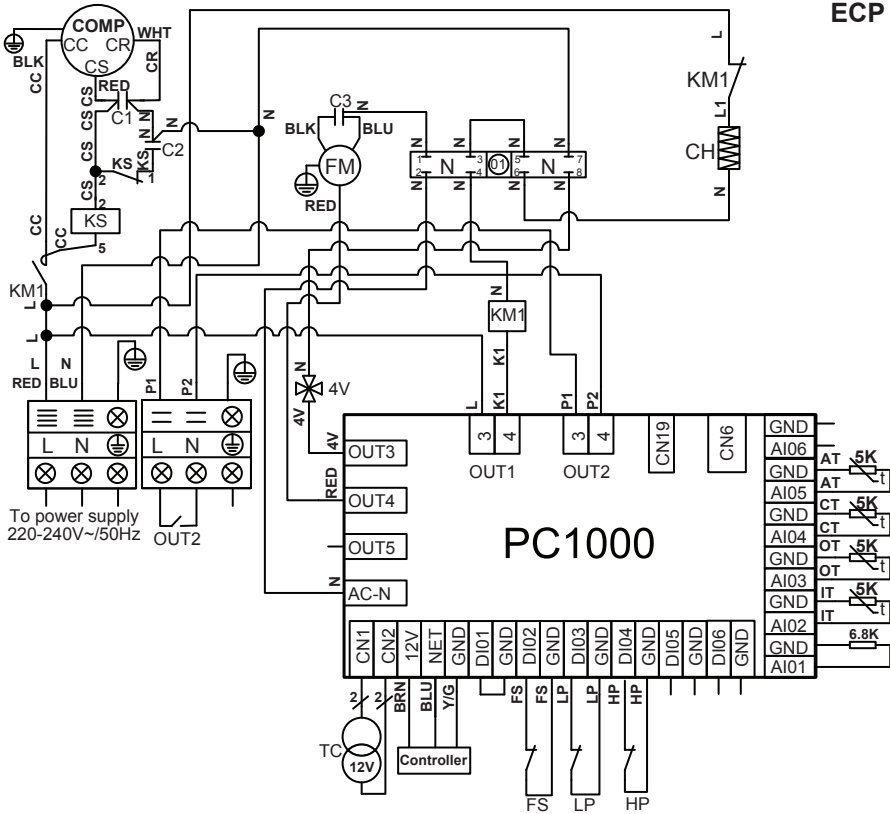

### ПРИМЕЧАНИЯ:

AT: ДАТЧИК ТЕМПЕРАТУРЫ ВОЗДУХА  
 COMP: КОМПРЕССОР  
 CH: СОПРОТИВЛЕНИЕ КОЖУХА  
 CT: ДАТЧИК ТЕМПЕРАТУРЫ ИСПАРИТЕЛЯ  
 FM: МОТОР ВЕНТИЛЯТОРА  
 FS: ДЕТЕКТОР НАЛИЧИЯ ВОДЫ  
 HP: РЕЛЕ ВЫСОКОГО ДАВЛЕНИЯ  
 IT: ДАТЧИК ТЕМПЕРАТУРА ВОДЫ НА ВХОДЕ

LP: РЕЛЕ НИЗКОГО ДАВЛЕНИЯ  
 OT: ДАТЧИК ТЕМПЕРАТУРА ВОДЫ НА ВЫХОДЕ  
 TC: ТРАНСФОРМАТОР 230 В~/12 В~  
 4V: ЧЕТЫРЕХХОДОВОЙ КЛАПАН  
 KM1: КОНТАКТОР МОЩНОСТИ КОМПРЕССОРА  
 C1: ПОСТОЯННЫЙ КОНДЕНСАТОР  
 C2: ПУСКОВОЙ КОНДЕНСАТОР  
 OUT2 : СВОБОДНЫЙ КОНТАКТ С МАКСИМАЛЬНЫМ ПОТЕНЦИАЛОМ 7А

KS: КАТУШКА ПУСКОВОГО РЕЛЕ КОМПРЕССОРА

## 6. ПРИЛОЖЕНИЯ (продолжения)

ECP 15

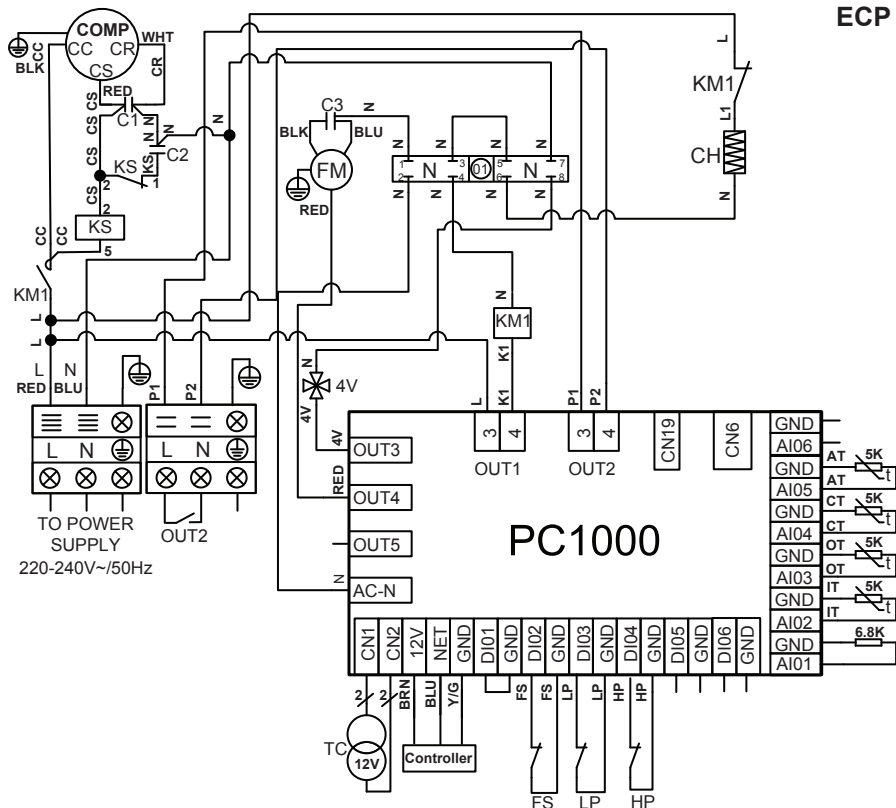

### ПРИМЕЧАНИЯ:

AT: ДАТЧИК ТЕМПЕРАТУРЫ ВОЗДУХА  
 COMP: КОМПРЕССОР  
 CH: СОПРОТИВЛЕНИЕ КОЖУХА  
 CT: ДАТЧИК ТЕМПЕРАТУРЫ ИСПАРИТЕЛЯ  
 FM: МОТОР ВЕНТИЛЯТОРА  
 FS: ДЕТЕКТОР НАЛИЧИЯ ВОДЫ  
 HP: РЕЛЕ ВЫСОКОГО ДАВЛЕНИЯ  
 IT: ДАТЧИК ТЕМПЕРАТУРА ВОДЫ НА ВХОДЕ

KS: КАТУШКА ПУСКОВОГО РЕЛЕ КОМПРЕССОРА

LP: РЕЛЕ НИЗКОГО ДАВЛЕНИЯ  
 OT: ДАТЧИК ТЕМПЕРАТУРА ВОДЫ НА ВЫХОДЕ  
 TC: ТРАНСФОРМАТОР 230 В~/12 В~  
 4V: ЧЕТЫРЕХХОДОВОЙ КЛАПАН  
 KM1: КОНТАКТОР МОЩНОСТИ КОМПРЕССОРА  
 C1: ПОСТОЯННЫЙ КОНДЕНСАТОР  
 C2: ПУСКОВОЙ КОНДЕНСАТОР  
 OUT2 : СВОБОДНЫЙ КОНТАКТ С МАКСИМАЛЬНЫМ ПОТЕНЦИАЛОМ 7А



## 6. ПРИЛОЖЕНИЯ (продолжения)

### 6.2 Включение подогрева в качестве приоритета (Однофазный насос)

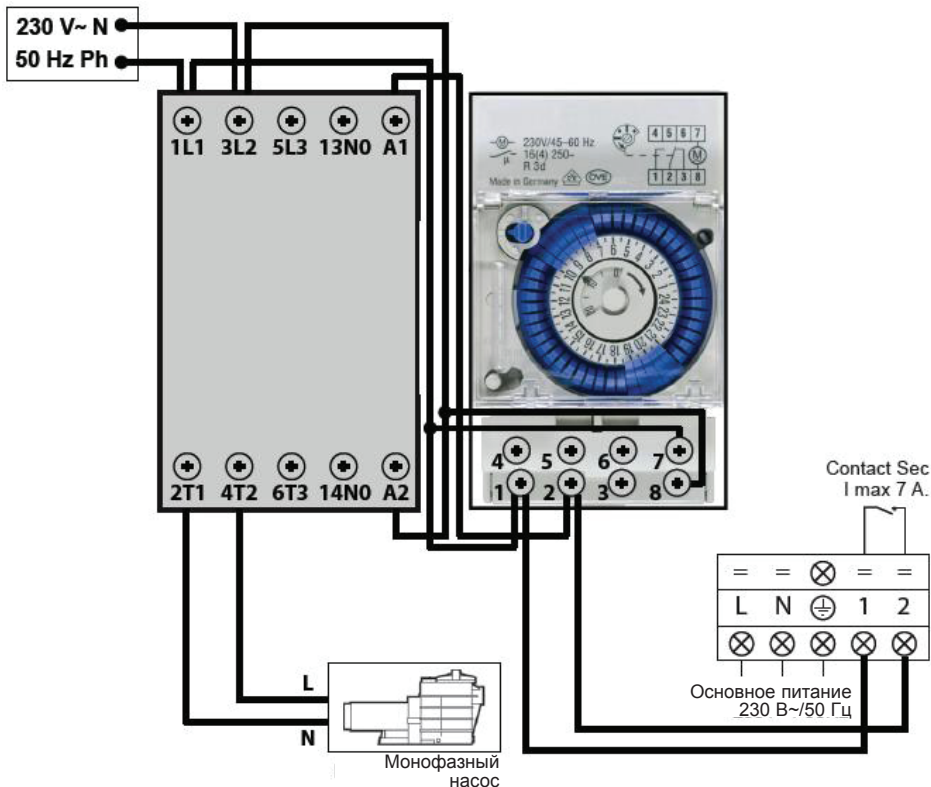

Разъемы 1 и 2 обеспечивают подачу питания на бесполярный контакт при напряжении 230 В 50 Гц. Подключите кабели к разъемам 1 и 2 в соответствии с указанной монтажной схемой для автоматической регулировки насоса фильтрации по циклам в 2 минуты каждый час, когда температура резервуара снижается ниже установленного значения.



Никогда не подключать питание фильтрационного насоса прямо к клеммам 1 и 2.

## 6. ПРИЛОЖЕНИЯ (продолжения)

### 6.3 Вид в разборе и запасные части

ЕСР 06

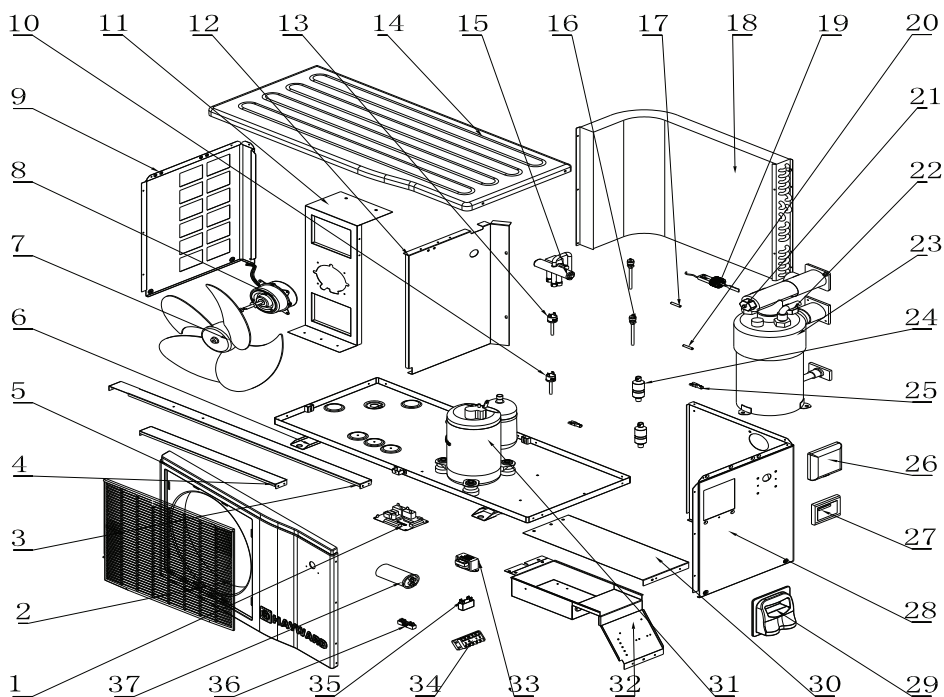

## 6. ПРИЛОЖЕНИЯ (продолжения)

### ЕСР06

Поз.	Справочный номер	Название	Поз.	Справочный номер	Название
1	HWX950531145	Электронная карта РС1000	20	HWX20003242	Датчик температуры воздуха
2	HWX35252208	Решетка	21	HWX20003242	Датчик температуры воздуха
3	HWX322521062	Задние ребра жесткости	22	HWX20003242	Датчик температуры воздуха
4	HWX322521063	Передние ребра жесткости	23	HWX32251210	Конденсатор Titane/ПВХ
5	HWX32025210084	Панель ABS, передняя	24	HWX20041444	Фильтр (Ø9,7-Ø9,7)
6	HWX32025210081	Рама	25	HWX200014068	Капиллярный разъем
7	HWX34012701	Лопасть вентилятора	26	HWX20002111	Защитное устройство контроллера
8	HWX34013301	Мотор вентилятора	27	HWX950531188	Контроллер, 7 сегментов
9	HWX32025210083	Левая панель	28	HWX32025210082	Правая панель
10	HWX20003603	Реле низкого давления	29	HWX32009220054	Ручка
11	HWX322521061	Опора двигателя	30	HWX322521064	Панель электрической защиты
12	HWX322521059	Перегородка	31	HWX200011006	Компрессор
13	HWX20013605	Реле высокого давления	32	HWX322521006	Распределительная коробка
14	HWX32025210085	Верхняя панель ABS	33	HWX200037006	Трансформатор 230 В~/12 В~
15	HWX20011418	Четырехходовой клапан	34	HWX40003901	Электрический переходник, 5-ти контактный
16	HWX200014153	Клапан Shrader	35	HWX20003506	Конденсатор вентилятора 2 мкФ
17	HWX20003242	Датчик температуры воздуха	36	HWX20003909	Переходник, 2-х контактный
18	HWX40001230	Испаритель	37	HWX20003504	Конденсатор компрессора 35 мкФ
19	HWX200036005	Датчик расхода	38	HWX20009910	Капиллярная трубка

## 6. ПРИЛОЖЕНИЯ (продолжения)

### ЕСР 08

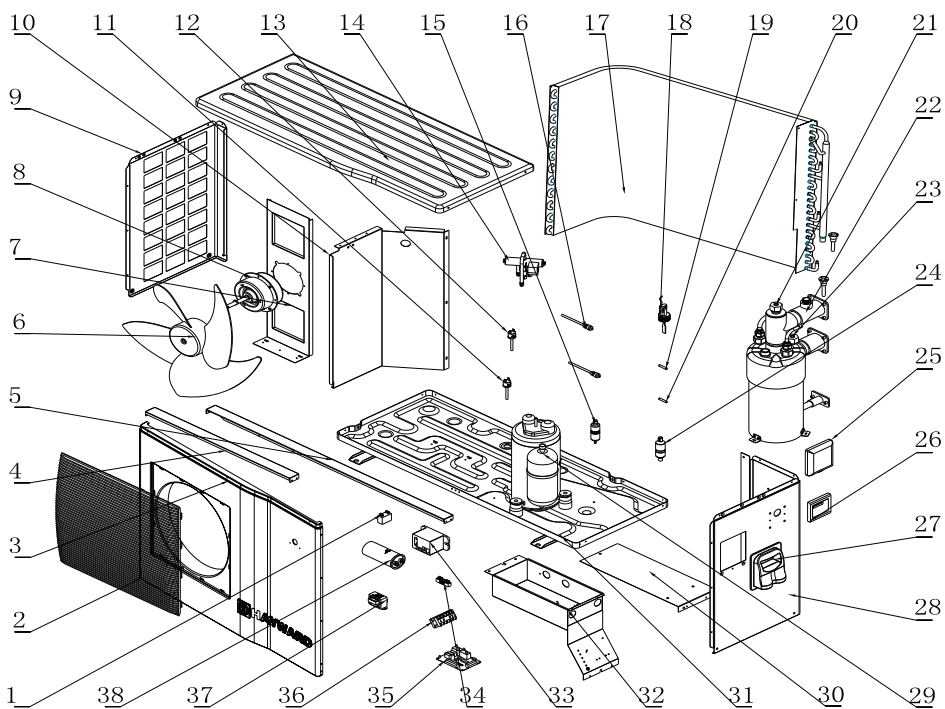

## 6. ПРИЛОЖЕНИЯ (продолжения)

### ЕСР 08

Поз.	Справочный номер	Название	Поз.	Справочный номер	Название
1	HWX20003501	Конденсатор вентилятора 3 мкФ	21	HWX20003242	Датчик температуры воздуха
2	HWX35122213	Решетка	22	HWX32081205	Конденсатор Titane/ПВХ
3	HWX32012210240	Панель ABS, передняя	23	HWX20003242	Датчик температуры воздуха
4	HWX321221175	Передние ребра жесткости	24	HWX20041445	Filter(Ф9.7-Ф4.2)
5	HWX321221018	Задние ребра жесткости	25	HWX20002111	Защитное устройство контроллера
6	HWX35002701	Лопасть вентилятора	26	HWX950531188	Контроллер, 7 сегментов
7	HWX321221174	Опора двигателя	27	HWX32009220054	Ручка
8	HWX34043301	Мотор вентилятора	28	HWX32012210238	Правая панель
9	HWX32012210238	Левая панель	29	HWX200011135	Компрессор
10	HWX321221173	Перегородка	30	HWX321221019	Панель электрической защиты
11	HWX20013605	Реле высокого давления	31	HWX32012210237	Рама
12	HWX20003603	Реле низкого давления	32	HWX321221176	Распределительная коробка
13	HWX32012210241	Верхняя панель ABS	33	HWX20003619	Реле
14	HWX20011418	Четырехходовой клапан	34	HWX20003909	Переходник, 2-х контактный
15	HWX20041446	Фильтр (Ø9,7-3,4)	35	HWX950531145	Электронная карта РС1000
16	HWX200014153	Клапан Shrader	36	HWX40003901	Электрический переходник, 5-ти контактный
17	HWX34061204	Испаритель	37	HWX200037006	Трансформатор 230 В~/12 В~
18	HWX200036005	Датчик расхода	38	HWX20003510	Конденсатор компрессора 60 мкФ
19	HWX20003242	Датчик температуры воздуха	39	HWX20009909	Капиллярная трубка
20	HWX20003242	Датчик температуры воздуха			

## 6. ПРИЛОЖЕНИЯ (продолжения)

### ЕСР 11

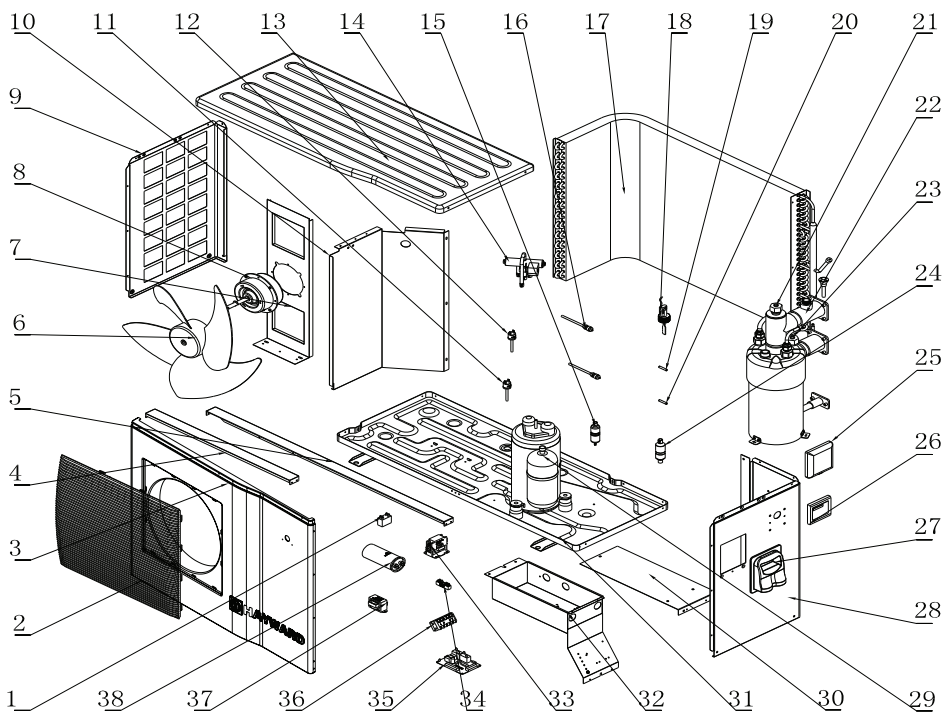

## 6. ПРИЛОЖЕНИЯ (продолжения)

### ЕСР 11

Поз.	Справочный номер	Название	Поз.	Справочный номер	Название
1	HWX20003501	Конденсатор вентилятора 3 мкФ	21	HWX20003242	Датчик температуры воздуха
2	HWX35122213	Решетка	22	HWX32121209	Конденсатор Titane/ПВХ
3	HWX32012210240	Панель ABS, передняя	23	HWX20003242	Датчик температуры воздуха
4	HWX321221175	Передние ребра жесткости	24	HWX20041445	Filter(Ф9.7-Ф4.2)
5	HWX321221018	Задние ребра жесткости	25	HWX20002111	Защитное устройство контроллера
6	HWX35002701	Лопасть вентилятора	26	HWX950531188	Контроллер, 7 сегментов
7	HWX321221174	Опора двигателя	27	HWX32009220054	Ручка
8	HWX34043301	Мотор вентилятора	28	HWX32012210238	Правая панель
9	HWX32012210238	Левая панель	29	HWX200011134	Компрессор
10	HWX321221173	Перегородка	30	HWX321221019	Панель электрической защиты
11	HWX20013605	Реле высокого давления	31	HWX32012210237	Рама
12	HWX20003603	Реле низкого давления	32	HWX321221176	Распределительная коробка
13	HWX32012210241	Верхняя панель ABS	33	HWX20003619	Реле
14	HWX20011418	Четырехходовой клапан	34	HWX20003909	Переходник, 2-х контактный
15	HWX20041446	Фильтр (Ø9,7-3,4)	35	HWX950531145	Электронная карта РС1000
16	HWX200014153	Клапан Shrader	36	HWX40003901	Электрический переходник, 5-ти контактный
17	HWX34061204	Испаритель	37	HWX200037006	Трансформатор 230 В~/12 В~
18	HWX200036005	Датчик расхода	38	HWX20003505	Конденсатор компрессора 60 мкФ
19	HWX20003242	Датчик температуры воздуха	39	HWX20009909	Капиллярная трубка
20	HWX20003242	Датчик температуры воздуха			

## 6. ПРИЛОЖЕНИЯ (продолжения)

---

### ЕСР 13

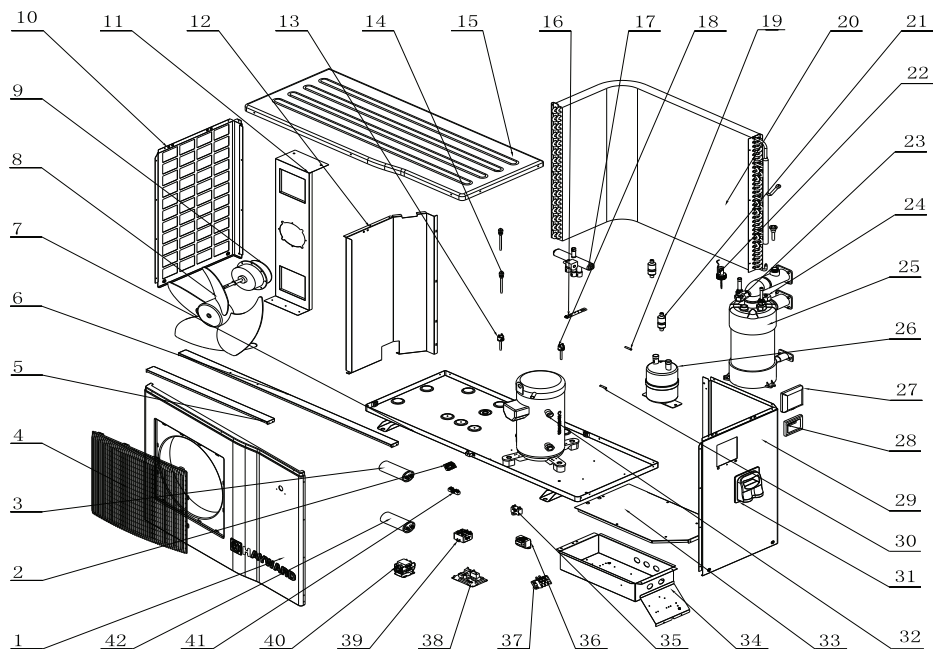



## 6. ПРИЛОЖЕНИЯ (продолжения)

### ЕСР 13

Поз.	Справочный номер	Название	Поз.	Справочный номер	Название
1	HWX32009210196	Панель ABS, передняя	23	HWX20003242	Датчик температуры воздуха
2	HWX20003933	Переходник, 3-х контактный	24	HWX20003242	Датчик температуры воздуха
3	HWX20003524	Конденсатор пусковой CPS, 98 мкФ	25	HWX32091206	Конденсатор Titane/ПВХ
4	HWX35122213	Решетка	26	HWX35001401	Аккумулятор
5	HWX320921015	Передние ребра жесткости	27	HWX20002111	Защитное устройство контроллера
6	HWX320921149	Задние ребра жесткости	28	HWX950531188	Контроллер, 7 сегментов
7	HWX32009210193	Рама	29	HWX32009210194	Правая панель
8	HWX35002701	Лопасть вентилятора	30	HWX20003242	Датчик температуры воздуха
9	HWX34043301	Мотор вентилятора	31	HWX32009220054	Ручка
10	HWX32009210195	Левая панель	32	HWX20011170	Компрессор
11	HWX320921147	Опора двигателя	33	HWX320921152	Панель электрической защиты
12	HWX320921148	Перегородка	34	HWX320921151	Распределительная коробка
13	HWX20013605	Реле высокого давления	35	HWX20003501	Конденсатор вентилятора 3 мкФ
14	HWX200014153	Клапан Shrader	36	HWX200037006	Трансформатор 230 В~/12 В~
15	HWX32009210197	Верхняя панель ABS	37	HWX20003920	Переходник, 3-х контактный
16	HWX20001489	Дроссельное устройство	38	HWX950531145	Электронная карта PC1000
17	HWX20011491	Четырехходовой клапан	39	HWX20003676	Реле
18	HWX20003603	Реле низкого давления	40	HWX200036007	Контактор компрессора
19	HWX20003242	Датчик температуры воздуха	41	HWX20003909	Переходник, 2-х контактный
20	HWX351212001	Испаритель	42	HWX20009909	Капиллярная трубка
21	HWX20041444	Фильтр (Ø9,7-Ø9,7)	43	HWX20003510	Конденсатор компрессора 60 мкФ
22	HWX200036005	Датчик расхода			

## 6. ПРИЛОЖЕНИЯ (продолжения)

---

ЕСР 15

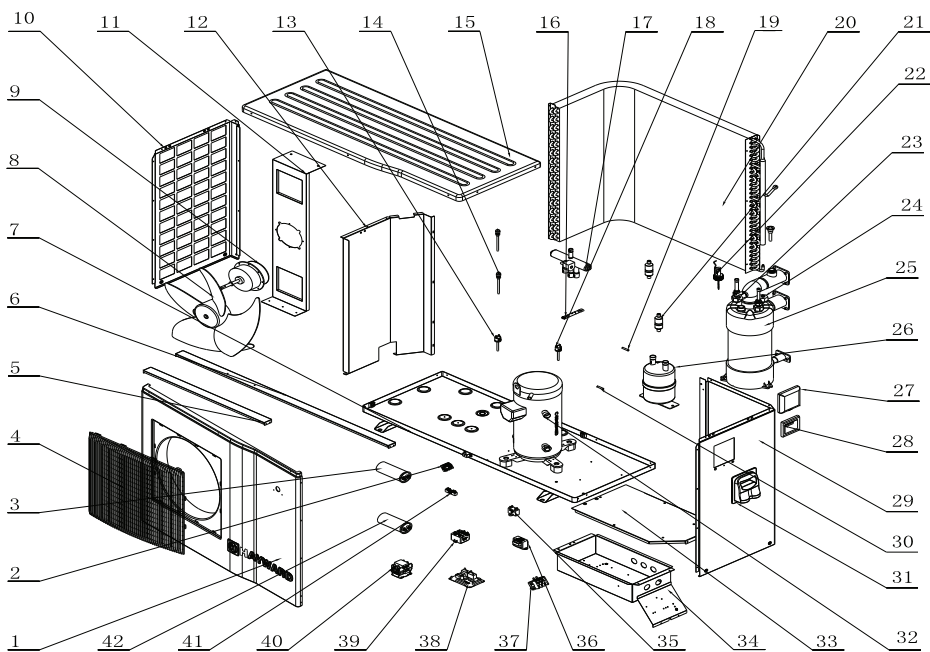

## 6. ПРИЛОЖЕНИЯ (продолжения)

### ЕСР 15

Поз.	Справочный номер	Название	Поз.	Справочный номер	Название
1	HWX32009210196	Панель ABS, передняя	23	HWX20003242	Датчик температуры воздуха
2	HWX20003933	Переходник, 3-х контактный	24	HWX20003242	Датчик температуры воздуха
3	HWX20003524	Конденсатор пусковой CPS, 98 мкФ	25	HWX32091206	Конденсатор Titane/ПВХ
4	HWX35122213	Решетка	26	HWX35001401	Аккумулятор
5	HWX320921015	Передние ребра жесткости	27	HWX20002111	Защитное устройство контроллера
6	HWX320921149	Задние ребра жесткости	28	HWX950531188	Контроллер, 7 сегментов
7	HWX32009210193	Рама	29	HWX32009210194	Правая панель
8	HWX35002701	Лопасть вентилятора	30	HWX20003242	Датчик температуры воздуха
9	HWX34043301	Мотор вентилятора	31	HWX32009220054	Ручка
10	HWX32009210195	Левая панель	32	HWX20011169	Компрессор
11	HWX320921147	Опора двигателя	33	HWX320921152	Панель электрической защиты
12	HWX320921148	Перегородка	34	HWX320921151	Распределительная коробка
13	HWX20013605	Реле высокого давления	35	HWX20003501	Конденсатор вентилятора 3 мкФ
14	HWX200014153	Клапан Shrader	36	HWX200037006	Трансформатор 230 В~/12 В~
15	HWX32009210197	Верхняя панель ABS	37	HWX20003920	Переходник, 3-х контактный
16	HWX20001489	Дроссельное устройство	38	HWX950531145	Электронная карта PC1000
17	HWX20011491	Четырехходовой клапан	39	HWX20003676	Реле
18	HWX20003603	Реле низкого давления	40	HWX200036007	Контактор компрессора
19	HWX20003242	Датчик температуры воздуха	41	HWX20003909	Переходник, 2-х контактный
20	HWX351212001	Испаритель	42	HWX20003510	Капиллярная трубка
21	HWX20041444	Фильтр (Ø9,7-Ø9,7)	43	HWX20009909	Конденсатор компрессора 60 мкФ
22	HWX200036005	Датчик расхода			

## 6. ПРИЛОЖЕНИЯ (продолжения)

### 6.4 Справочник по устранению неисправностей



*Некоторые операции должны выполняться квалифицированными специалистами.*

Нарушения в работе	Коды ошибок	Описание	Устранение
Неисправность датчика воды на входе	P01	Датчик открыт или произошло короткое замыкание	Проверить или заменить датчик.
Неисправность датчика воды на выходе	P02	Датчик открыт или произошло короткое замыкание	Проверить или заменить датчик.
Неисправность датчика температуры окружающей среды	P04	Датчик открыт или произошло короткое замыкание	Проверить или заменить датчик.
Неисправность датчика оттаивания	P05	Датчик открыт или произошло короткое замыкание	Проверить или заменить датчик.
Защита от высокого давления	E01	Давление в холодильной системе слишком высокое, или пропускная способность слишком низкая, или засорен испаритель, или приток воздуха слишком слабый.	Проверьте реле высокого давления и давление в холодильной системе. Проверьте расход воды или воздуха. Проверьте исправность контроллера пропускной способности. Проверьте, открыты ли вентили на входе и выходе воды. Проверьте регулировку перепускной системы.
Защита от низкого давления	E02	Давление в холодильной системе слишком низкое, или слабый приток воздуха, или закупорен испаритель.	Проверьте реле низкого давления и давления в холодильной системе, чтобы убедиться в наличии возможной утечки. Очистите поверхность испарителя. Проверьте скорость вращения вентилятора. Проверьте наличие свободного доступа воздуха к испарителю.
Неисправность детектора пропускной способности	E03	Недостаточная пропускная способность в отношении воды, или короткое замыкание детектора, или детектор неисправен	Проверьте пропускную способность в отношении воды, фильтрационный насос и детектор пропускной способности на предмет возможных неисправностей.
Слишком большая разница температур воды на выходе и на входе	E06	Недостаточная пропускная способность, разница давления воды незначительная/чрезмерна.	Проверьте пропускную способность или наличие закупоривания системы.
Защита от замерзания Холодный режим	E07	Количество воды на выходе слишком мало.	Проверьте пропускную способность или датчик температуры воды на выходе.
Проблемы с соединением	E08	Нарушения в работе контроллера LED или соединения монтажной платы.	Проверьте соединения проводов.
Защита от замерзания — уровень 1	E19	Температура окружающей среды или воды на входе слишком низкая.	Остановите тепловой насос и слейте содержимое конденсатора. Защита от замерзания.
Защита от замерзания — уровень 2	E29	Температура окружающей среды или воды на входе еще более низкая.	Остановите тепловой насос и слейте содержимое конденсатора. Защита от замерзания.

## 6. ПРИЛОЖЕНИЯ (продолжения)

---

### 6.5 Гарантия

#### ГАРАНТИЙНЫЕ ОБЯЗАТЕЛЬСТВА

На всю продукцию компании HAYWARD в течение двух лет с момента приобретения распространяется гарантия отсутствия дефектов, связанных с работой или материалами. Настоящая гарантия действительна лишь при предъявлении документа, подтверждающего факт и дату покупки. В связи с этим мы рекомендуем сохранять товарный чек.

Гарантия компании HAYWARD сводится лишь к ремонту или замене, по выбору компании HAYWARD, дефектного изделия при условии его нормальной эксплуатации в соответствии с требованиями инструкции по эксплуатации, отсутствия каких-либо модификаций изделия и использования компонентов и запасных частей исключительно компании HAYWARD. Действия гарантии не распространяются на последствия воздействия мороза и химических веществ.

Все прочие расходы (доставка, производство работ и т. д.) не включены в гарантию.

Компания HAYWARD не несет ответственности за любой ущерб, прямой или косвенный, являющийся следствием неправильной установки, подключения или работы изделия.

Для того чтобы воспользоваться гарантией и потребовать возмещения стоимости или замены изделия, обратитесь к Вашему продавцу. Возврат изделия на завод-изготовитель невозможен без нашего предварительного письменного согласия.

Гарантия не распространяется на быстроизнашивающиеся детали.



Hayward is a registered trademark  
of Hayward Industries, Inc.  
© 2014 Hayward Industries, Inc.

